



**INTEC**<sup>®</sup>  
LIGHT

**outdoor**

**Technische Außenbeleuchtung**  
Technical outdoor lighting

de/en

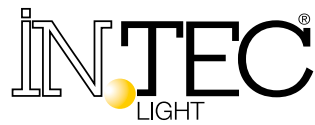

**Wenn die Forschung Antworten auf  
die Anforderungen findet, alte wie neue.  
Wenn die Technologie Probleme löst.  
Wenn Technik und Ästhetik harmonisch eins werden.  
Dort entstehen die glänzendsten Lösungen.**

When research finds solutions  
to needs, both old and new.  
When technology solves problems.  
When technology and aesthetic  
appeal harmoniously merge.  
That's when the bright solutions are born.

**outdoor**

**Technische Außenbeleuchtung**  
Technical outdoor lighting





**INTEC**  
LIGHT

Technische  
Beleuchtung /  
Technical lighting

LUCE  
ambiente  
**Design**

Dekorative  
Beleuchtung /  
Decorative lighting

**MiBYMi**

Spiegel mit  
LED-Beleuchtung /  
Mirrors with  
LED lighting

Napoli - Italy



Montpellier - France



Milano - Italy



# GESTERN UND HEUTE PRÄSENT / YESTERDAY AND TODAY, PRESENT



## Eine über 100 Jahre lange Entwicklung

Unsere Geschichte begann zu Beginn des 20. Jahrhunderts in Neapel. Es ist eine Geschichte voller Engagement, Entwicklung und Mut. Eine Geschichte, deren Verlauf ununterbrochen mit der des Glases verbunden ist. Generation um Generation entwickelt sich **FAN Europe Lighting** weiter, ändert seine Form und setzt seine Vorstellung von Produkt und Service mit dem Ziel um, ein Ansprechpartner für den gesamten Beleuchtungssektor zu werden.

## Unser Unternehmen heute

Heute ist **FAN Europe Lighting** ein großartiges Team von Personen und Ressourcen. Das Streben nach Exzellenz bei der Qualität der Produkte kombinieren wir mit einem Ökosystem aus Dienstleistungen und Garantien, die wir den Anforderungen und den Kunden entsprechend entwickelt und organisiert haben. Unsere italienische Tradition lässt uns die Bedeutung von Originalität und Sorgfalt bei der Produktfertigung nicht aus den Augen verlieren. Unser Drang zu wachsen treibt uns dazu, immer mit der Beleuchtung von heute und morgen Schritt zu halten, einer Beleuchtung, die immer intelligenter und umweltfreundlicher wird und sich ständig wandelt.

Our history began in Naples in the early 1900s. It's a history of commitment, evolution and courage. A history that follows the thread of time, constantly intertwining with that of glass.

Generation after generation, **FAN Europe Lighting** has evolved, changing shape, developing its concept of products and services to become a benchmark for the entire lighting industry.

Today, **FAN Europe Lighting** is a vast team of people and resources. In addition to pursuing excellence in product quality, we combine an ecosystem of services and guarantees, which we have developed and tailored to our customers' needs.

Our Italian heritage does not allow us to forget the importance of originality and product care. Our desire to grow motivates us to always keep up with the lighting of today and tomorrow, lighting that is always smarter, more eco-friendly and evolving.

**An evolution  
spanning more  
than 100 years**

**Our  
company,  
today**





**Qualität an erster Stelle**

Hochwertige Komponenten, Mehrfachkontrollen, Prüfungen während der Entstehungsphase: Bei der Qualität gehen wir nie Kompromisse ein. Dank eines Teams von Experten sind wir in der Lage, modernste Technologie, jedes Jahr verbesserte Finish und langlebige neue Designformen zu garantieren.

**Die umfassendste Produktpalette**

Wir sind eines der wenigen Unternehmen der Welt, die so zahlreiche Zielbranchen abdecken: von industrieller Beleuchtung bis zu dekorativen Erzeugnissen. Wir sind "leidenschaftliche Forscher" und erweitern das Produktangebot jedes Jahr um im Trend liegende Kollektionen und die vielversprechendsten Innovationen in Hinblick auf Technologie und Nachhaltigkeit.

Durch die stilistische und technologische Weiterentwicklung der Beleuchtung hat sich die Forschung in der Beleuchtungstechnik auf maßgefertigte Beleuchtungsprojekte konzentriert, bei denen die Beleuchtungskörper Instrumente im Dienste des Architekturprojekts sind. Diese Entwicklungsphase hat uns dazu geführt, unsere Abteilung für Projekte und Beleuchtungstechnik speziell für individuell gestaltete Projekte zu erweitern. Die Abteilung ist bereits jetzt für Dienstleistungen im Bereich Planung, Prototypenbau, Prüfung und Produktionskontrolle für jedes in unserem Katalog enthaltene Produkt zuständig. Wenn die Produkte nicht den Anforderungen des Kunden entsprechen, stellen wir "kundenspezifische" Produkte nach Maß für die Anforderungen des Projekts her und um die Umgebungen des Beleuchtungsdesigns im höchsten Maße zur Geltung zu bringen. Dank Programmierwerkzeugen und Software zur photometrischen Berechnung können wir für jedes neue Produkt die photometrischen Berechnungen für einen geeigneten beleuchtungstechnischen Projektverlauf zur Verfügung stellen.

Quality components, multiple checks, testing during the manufacturing process: we never compromise on quality. With our team of experts, we can guarantee cutting-edge technology, new improved finishes every year and new designs that will stand the test of time!

**Quality comes first**

We are one of the few companies in the world to cover so many target sectors: from industrial lighting to decor products. As "passionate researchers" every year we enrich our range with trend-setting collections and the most efficient innovations in terms of technology and sustainability.

**The most comprehensive range of products**

The stylistic and technological evolution of lighting has steered lighting research towards custom-made lighting projects, in which luminaires are used to support architectural design. This evolutionary phase encouraged us to expand our Project and Lighting department focusing on custom-made projects. The department already provides design, prototyping, testing and production monitoring services for all the products in our catalogue. When products don't meet the customer's needs, we make bespoke products to meet project requirements and fully enhance lighting design contexts. Using computer tools and photometric calculation software, we can provide photometric calculations for each new product thereby appropriately developing the lighting design project.

## WIR SIND UMWELTFREUNDLICH / WE ARE ECO-FRIENDLY

**Wir haben Kunststoff aus unseren Verpackungen verbannt. Wir wählen und bevorzugen Materialien aus nachhaltigen Ressourcen. Wir erforschen die Technologien mit bester Energieeffizienz in Kombination mit intelligenten Systemen, die in der Lage sind, den Verbrauch noch weiter zu reduzieren. All dies und noch vieles mehr stellt unser Engagement für Nachhaltigkeit unter Beweis.**

We no longer use plastic in our packaging. We select and prefer materials from sustainable resources. We research the most energy-efficient technologies combined with smart systems that further reduce consumption. All this, and much more, shows our commitment to sustainability!





**Höchste  
Produktverfügbarkeit**

Wir sind immer für Sie da! Mit unserer Hilfsbereitschaft, Professionalität und einem klaren Ziel: das Leben unserer Kunden zu vereinfachen. Ein Versprechen an alle, die uns nicht kennen. Eine verlässliche Garantie für alle, die seit Jahren mit uns arbeiten!

Wir verfügen über eines der breitesten Sortimente an Artikeln auf dem Markt, doch sind in der Lage, jederzeit 98% Verfügbarkeit zu garantieren. Wir garantieren, dass die verbleibenden 2% innerhalb von 30 Tagen wieder verfügbar sind!

We are always here for you! With our helpfulness, professionalism and a clear goal: to make life easier for our customers. It's a promise we make to those who don't know us. It's an established guarantee for those who have worked with us for years! We have one of the widest ranges of items on the market, but we can guarantee 98% availability at all times. We guarantee that the remaining 2% will be available in 30 days!

**Maximum  
product  
availability**

**Schneller  
und sicherer  
Versand**

Im Laufe der Jahre haben wir ein leistungsfähiges Logistiksystem entwickelt, das in der Lage ist, Lieferungen innerhalb von 24 Stunden in Italien und von 48 Stunden in Europa und gleichzeitige höchste Umsicht während des Transports zu garantieren. Unser mehrsprachiges Team steht unseren Kunden außerdem unterstützend und betreuend zur Seite.

Over the years, we have developed an efficient logistics system that guarantees deliveries within 24h in Italy and 48h in Europe, ensuring maximum care during transport. Our multilingual team also provides customers with support and assistance.

**Quick and safe  
shipments**



## ANLEITUNG ZUM LESEN DER TABELLEN / GUIDE TO READING THE TABLES

**Jede Kollektion wird von einem  
oder mehreren Symbolen für den  
Bestimmungszweck begleitet**

Every collection will  
be distinguished by a  
symbol for intended use

**Name und Merkmale der Kollektion**

Collection name and characteristics



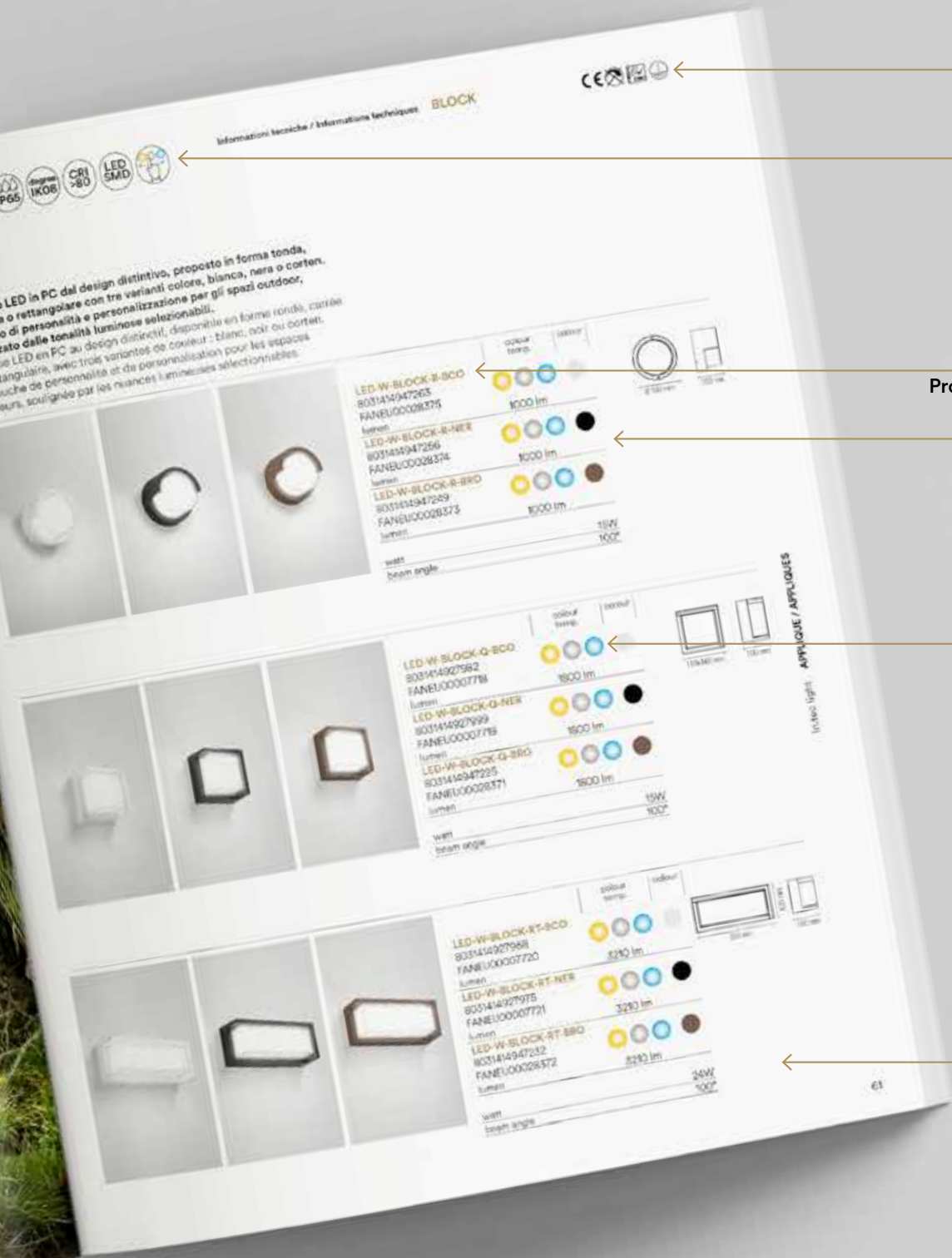

**Zertifizierung und Bestimmungen**  
 Certification and regulations

**Produkteigenschaften**  
 Product characteristics

**Produktcode, EAN-Code und METEL-Code**  
 Product code, EAN code and METEL code

**Farbvariante**  
 Colour variance  
 wo vorhanden / where existing

**Farbtemperatur (LED) ausgedrückt  
 in Kelvin + Lumen**  
 Colour temperature in Kelvin + lumen  
 ove esistente / where existing

**Leistung**  
 Power  
 Für Produkte ohne eingebaute  
 LED-Lampenfassungsdaten  
 mit max. zertifizierter Leistung  
 For the products without built-in  
 LED max lamp holder power  
 as required by CE certificate

Steuersysteme  
für unsere  
SMART-Produkte /  
Control system  
easy installation



Smart Intec WIFI



RF 2.4G control system



Alexa e Google Home  
voice control

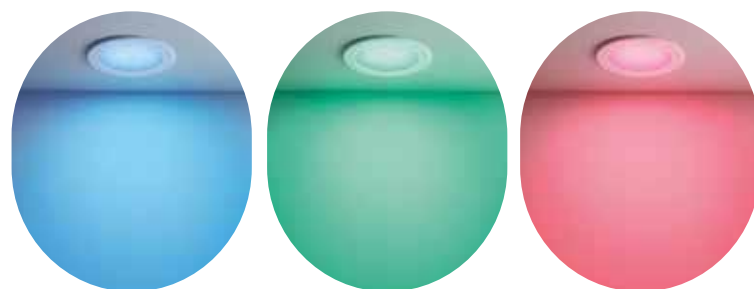

**EASY DOMOTICA** Mit diesem technischen Segment möchten wir dem wachsenden Bedarf daran gerecht werden, die Qualität von Privat- und Arbeitsleben durch den Einsatz von Beleuchtungsgeräten zu verbessern, die durch Wireless-Technologien zunehmend vereinfachte Anbindungen immer stärker miteinander verknüpft sind. Die Beleuchtungsgeräte werden zu extrem individuell gestalteten und modularen Elementen, die sich, auch zu unterschiedlichen Tageszeiten, an die veränderten Anforderungen an Beleuchtung anpassen, die nicht mehr nur als solche an sich dient, sondern auf verschiedene Stimmungen, sowohl der gewerblichen als auch der häuslichen oder spielerischen Nutzung, abgestimmt ist. In diesem Abschnitt sind die Niederspannungsprodukte gruppiert, die mit Konstantspannungsnetzteilen parallelgeschaltet werden können und sich durch ihre extreme Flexibilität und Modularität auszeichnen, da sie mit Steuergeräten für 2,4-G-Funkfrequenz, Infrarot, Wi-Fi oder Bluetooth kompatibel sind. Die Steuergeräte sehen ihrerseits Wi-Fi- bzw. Bluetooth-Schnittstellen vor oder können mittels Wall Pads oder Funksteuerungen bedient werden.

**EASY DOMOTICA** With this technical segment, we intend meet in the best way the growing need to improve the quality of home and working life through the use of lighting devices that are increasingly interconnected with each other through connections that are increasingly simplified by wireless technologies. The lighting devices become an extremely personalized and modular tool that merge, even at different times of the day, with the evolved lighting needs no longer as light source itself but light adapted to the different moods of both professional users, domestic users, playful users. This section groups low voltage products that can be connected with constant voltage power supply in parallel connection system and are characterized by extreme flexibility and modularity as they are compatible with 2.4G Radio Frequency, Infrared, Wifi or Bluetooth control units. The control units can be controlled by wifi, bluetooth devices or can be controlled via a wall pad or remote control.



Alle Leuchten können über die APP INTEC und SMART LIFE standortfern gesteuert werden/  
All luminaires can be remotely controlled with INTEC and SMART LIFE APPs.

Laden Sie die App Smart Intec herunter unter /  
Download App Smart Intec on:



**APP INTEC WI-FI** Für jeden Moment des täglichen Lebens bedarf es des richtigen Lichts. Dank der Smart-Beleuchtung ist es mit unseren Wi-Fi- und Bluetooth-Geräten möglich, für alle Momente die ideale Atmosphäre zu schaffen. Über unsere App Smart INTEC ist es möglich, alle Beleuchtungsgeräte zu steuern, um sie ein- oder auszuschalten, die Farbtemperatur in Kelvin des Lichts zu ändern und außerdem Szenen einzustellen. Unter unseren Artikeln finden Sie eine Auswahl an einbaufertigen Produkten mit integrierter LED doch auch sämtliche erforderlichen Zubehörteile, um jedes beliebige Gerät smart zu machen. Sobald die Lampe angeschlossen und die App INTEC heruntergeladen wurde, erfolgt die Einrichtung der verschiedenen Zimmer dank der schrittweisen Anleitungen auf einfache und intuitive Weise. Zur Steuerung unserer Smart-Produkte können auch die Smart Speaker und Videos von Amazon und Google verwendet werden. Aktivieren Sie die Funktion und steuern Sie die Geräte einfach mit Ihrer Stimme.

**APP INTEC WI-FI** Every moment of everyday life require the right light. Thank to the Smart lighting it will be possible to create the ideal atmosphere connecting them and controlling them thorough Wi-fi or Bluetooth connection. **With our APP Smart Intec** it is possible to control from remote all the lighting devices with on-off, kelvin colour temperature changing, light colour and scenes functions. To instore some smart lamps it is necessary just your standard home electric connection, and wifi connection. Once connected the lamp and downloaded the APP Smart Intec it will be very easy to create groups and rooms in very easy process thank to the instructions step by step on the App. The smart lamps can be controlled also with Wifi voice control devices.

**SMART INTEC Bluetooth Sig Mesh** Der Bluetooth-Standard wurde für die Beleuchtung in Industrie, Gewerbe und Haushalt mit offenen Armen empfangen, da es sich um eines der einfachsten und günstigsten Steuersysteme für intelligente Beleuchtung handelt, dem bei der Vereinfachung des Dialogs zwischen Beleuchtungsgeräten eine Schlüsselrolle zukommt. Unsere Artikel der Reihe Bluetooth Sig Mesh können mit den intelligenten Geräten über die APP Smart Intec verbunden werden und jedes Beleuchtungsgerät kann über ein Mesh-Netzwerk in einem Abstand von 15 m für jedes Gerät mit einer weiteren unendlichen Anzahl von Geräten kommunizieren. Das Mesh-Bluetooth-Netzwerk kann dank der Verbindung des Bluetooth-Gateways standortfern mittels Wi-Fi gesteuert werden, das sich wiederum mit den Sprachsteuerungsgeräten Alexa und Google verbinden kann. Für alle Nutzer sind die Mesh-Bluetooth-Produkte auch bequem zu verwenden. Ein von einem Netzwerk von Großgeräten aktiviertes Mesh-Bluetooth-Netzwerk, das in der Lage ist, den niedrigen Energieverbrauch zu nutzen, kann tausende von gleichzeitig arbeitenden Geräten unterstützen. So können Sie, gleich ob zu Hause oder im Büro, immer eine große Anzahl von gleichzeitig angebotenen intelligenten Geräten betreiben. Folglich stellen die intelligenten Bluetooth-Mesh-Produkte eine ganze Reihe von Annehmlichkeiten zum Leben und Arbeiten zur Verfügung, ohne sich um hohe Energiekosten Sorgen machen zu müssen. In der smarten Wohnung senkt Bluetooth die Hemmschwelle bei der Nutzung von Haustechnikgeräten durch seinen geringen Energieverbrauch, die umfassende Kompatibilität und sein hohes Sicherheitspotenzial und sorgt so für eine günstigere, benutzerfreundlichere und intelligentere Heimautomatisierung. Ohne die Freigabe durch den Benutzer ist das Bluetooth-Signal nicht in der Lage, sich zu verbinden und das Gerät zu verfolgen, sodass der Datenschutz des Benutzers gewahrt bleibt.

**SMART INTEC Bluetooth Sig Mesh** Bluetooth mesh has been well received across the industrial, commercial and domestic lighting, as one of the easiest and much convenient smart lighting control systems playing a key role in facilitating the inter-dialogue between lighting devices. Our Bluetooth mesh items can be connected with the smart devices through the APP Smart Intec and each lighting device can communicate with other infinite number of devices through the mesh network with all other devices within a distance of 15m. The Bluetooth mesh network can be controlled from remote area through Wifi thank to the connection of Bluetooth gateway that can connect in turn to Alexa and Google voice controls. For individual users, Bluetooth mesh products are also convenient to use. Enabled by a large-scale device network and able to take advantage of low power consumption, a Bluetooth mesh network can support thousands of devices working simultaneously. So, no matter if you are at home or in the office, you can always run a large number of connected smart devices at the same time. As a result, Bluetooth mesh smart products provide a full range of conveniences for living and working without worrying about high energy costs. In the smart home, Bluetooth lowers the threshold of using smart home devices with its low power consumption, high compatibility, and high-security characteristics, providing a lower cost, more user-friendly, and smarter home experience. Without the user's permission, the Bluetooth signal will not be able to connect and track any device, protecting the user's privacy.

# PRODUKTEIGENSCHAFTEN / PRODUCT FEATURES

Erläuternde Legende zum Verwendungszweck des Produkts / Explanatory legend of the product's intended use



Hausgebrauch / domestic use



Außengebrauch / outdoor use



Beherbergungsbetriebe / accommodation areas use



Büros / office use

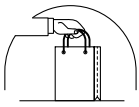

Gewerbliche Bereiche / commercial areas



Städtische Nutzung / urban use



Industrieanwendungen / industrial use



Badezimmer / bathroom use



Eingebaute SMD-LED / Built-in SMD LED



Eingebaute COB-LED / Built-in COB LED



Produkt mit hoher Lichtausbeute / High luminous efficiency product



RGB-Produkt / RGB product

RGB+UV-Produkt / RGB+ UV product

RGB+W+UV-Produkt / RGB+white+UV product



RAINBOW-Produkt / RAINBOW product



CCT-Produkt (dynamisches Weiß) / Adjustable white



Auswählbare Farbtemperatur (2700K 3000K 4000K) / Interner Schalter zur individuellen Kelvin-Auswahl / Selectable color temperature (2700K 3000K 4000K) / Internal switch for customization of Kelvin



Auswählbare Farbtemperatur (3000K 4000K 6000K) / Interner Schalter zur individuellen Kelvin-Auswahl / Selectable color temperature (3000K 4000K 6000K) / Internal switch for customization of Kelvin



Auswählbare Farbtemperatur (3000K 4000K) / Interner Schalter zur individuellen Kelvin-Auswahl / Selectable color temperature (3000K 4000K) / Internal switch for customization of Kelvin



MEMORY FUNCTION

3-Step-CCT / Regulierung von warmem, natürlichem, kaltem Licht. Speicherfunktion mittels Wandschalter / 3 step CCT / Warm, natural and cold light control. Memory function by means of a wall switch



TOUCH DIMMER

Touch-Dimmer / Regulierbare Lichtstärke / Touch dimmer / Dimmable light intensity



Touch-Step-Dimmer / Touch-Schalter mit 3 Helligkeitsstufen / Touch step dimming / Step - 3 step brightness touch switch



x1-100% x2-50% x3-10%

3-Step-DIM / Die 3-Step-Dimmer gestatten die Regulierung der Beleuchtungsstärke über den Wandschalter / 3 step DIM / 3 step dimming function: modulation of light intensity by wall switch



Dimmer / Einstellbare Helligkeit mit Fernbedienung / Dimming / Adjustable brightness with remote control



TRIAC

Standard-Dimmungstechnologie mit Phasenanschnitt (normalerweise Leading Edge) mit einer Einstellung, die das gesamte Intervall von 1 % bis 100 % abdeckt / Standard phase-cut dimming technology (typically Leading Edge), with adjustment covering the entire range from 1% to 100%.



TRIAC-ELV

Dimming mit spezifischem Phasenanschnitt für elektronische Lasten mit Kleinspannung (ELV), mit einem sehr präzisen Bereich von 1 % bis 100 % / Phase-cut dimming specifically for low voltage (ELV) electronic loads, with a very precise range from 1% to 100%.



PHASE-CUT

Phasenanschnittsteuerung mit einem garantierten Dimmbereich zwischen 10 % und 100 % / Phase-cut adjustment with a guaranteed dimming range from 10% to 100%.



PUSH-DIM

Steuerung der Helligkeit durch Betätigen einer Taste / Brightness control at the touch of a button.



1-10V DC

System, das zur Steuerung der Lichtstärke ein Gleichstromsignal zwischen 1 V und 10 V verwendet / A system using a DC signal between 1V and 10V to control light intensity.



Eingebauter Touch-Schalter /  
Built-in touch switch



Farbwiedergabeindex /  
Colour rendering index



UGR ist ein von der CIE (Internationale Beleuchtungskommission) entwickelter, international standardisierter Index zur Bewertung der direkten Blendung durch die Beleuchtungsanlage. Die europäische Norm über die Beleuchtung von Arbeitsstätten in Innenbereichen **UNI-EN 12464-1** schreibt einen spezifischen UGR-Wert für jedes Gerät zwischen **10 und 30 vor: je niedriger der Wert, desto geringer die Blendung** / UGR is an international unified data, developed by CIE (commission international de l'Enclairage) for the evaluation of the glaning degree of the light sources. The European norme for the lighting of te specifical working place **UNI-EN 12464-1** requires a value UGR for every application, included between **10 and 30: lower is the value, lower is the anti glare ratee.**



Lichtquelle /  
Light source

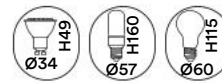

Empfohlene Glühbirnengröße /  
Recommended bulb size



Notleuchte /  
Emergency light



Sonnenenergieprodukt /  
Solar energy product



Begehbar /  
Walkable  
max 2000kg



Indoor- und Outdoor-Produkt /  
Indoor e outdoor product



Bluetooth-Verbindung /  
Bluetooth connection



Streichbarer Gips /  
Gypsun paintable



Zement /  
Concrete



Schallabsorbierendes System /  
Sound-absorbing system



Schwimmendes Produkt /  
Floating product



Korrosionsfreies Produkt /  
Corrosion-free



Einbauleuchten:  
asymmetrischer  
Lichtstrahl /  
Recessed lamps:  
description of asymmetrical  
light emission type



Einbau- und Orientierungsleuch-  
ten: Lichtstrahlrichtung /  
Inground and walk lights:  
description of light emission type



Deckenleuchten:  
Lichtstrahlrichtung /  
Ceiling lamps: description  
of light emission type



Wandleuchten:  
Lichtstrahlrichtung /  
Wall lamps: description  
of light emission type

# SCHUTZART / IP PROTECTION RATE



## IP-Klasse / IP Class

Alle im Katalog enthaltenen Produkte ohne spezifische IP-Schutzart sind als IP20 zu verstehen.

All items in the catalogue without IP rating specific are IP20.



**Schutz gegen feste Fremdkörper**  
Protection against solid bodies

**0**  
Kein Schutz /  
No protection

**1**  
Geschützt gegen feste Fremdkörper mit Durchmesser über 50 mm /  
Protected against solid bodies larger than 50 mm

**2**  
Geschützt gegen feste Fremdkörper mit Durchmesser über 12 mm /  
Protected against solid bodies larger than 12 mm

**3**  
Geschützt gegen feste Fremdkörper mit Durchmesser über 2,5 mm /  
Protected against solid bodies larger than 2,5 mm

**4**  
Geschützt gegen feste Fremdkörper mit Durchmesser über 1 mm /  
Protected against solid bodies larger than 1 mm

**5**  
Geschützt gegen Staub in schädigender Menge /  
Protected against dust no harmful deposit

**6**  
Staubdicht /  
Completely protected against dust

**Schutz gegen Flüssigkeiten**  
Protection against liquids

**0**  
Kein Schutz /  
No protection

**1**  
Schutz gegen Tropfwasser /  
Protected against vertically-falling drops of water

**2**  
Schutz gegen fallendes Tropfwasser, wenn das Gehäuse bis zu 15° geneigt ist /  
Protected against drops of water falling at up to 15° from the vertical

**3**  
Schutz gegen fallendes Tropfwasser, wenn das Gehäuse bis zu 60° geneigt ist /  
Protected against drops of water falling at up to 60° from the vertical

**4**  
Gegen Wassertropfen aus allen Richtungen geschützt /  
Protected against projections of water from all directions

**5**  
Schutz gegen Strahlwasser aus beliebigem Winkel /  
Protected against jets of water from all directions

**6**  
Schutz gegen starkes Strahlwasser /  
Protected against jets of water of similar force heavy seas

**7**  
Schutz gegen zeitweiliges Untertauchen /  
Protected against the effects of immersion

**8**  
Schutz gegen dauerndes Untertauchen /  
Protected against pro-longed the effects of immersion under pressure

**Schutz gegen Wasser bei Hochdruck-/ Dampfstrahlreinigung /**  
Protection against water in case of high-pressure/steam jet cleaning



## IK-Klasse / IK Class

**Schutzarten der Gehäuse für Elektrogeräte gegen äußere mechanische Beanspruchung**

Degrees of protection for enclosures for electrical equipment against external mechanical impacts.

IK	Aufprallenergie (in Joule) / Impact energy (in Joules)
00	0
01	0,15
02	0,2
03	0,35
04	0,5
05	0,7
06	1
07	2
08	5
09	10
10	20

Schutzklasse /  
Appliance class

**Die Schutzklassen stellen die von der IEC (International Electrotechnical Commission) festgelegte einheitliche Gruppierung der für ein Elektrogerät geltenden technischen Eigenschaften dar, um die Stromschlaggefahr durch einen Defekt desselben zu begrenzen.**

The electrical insulation classes are the homogeneous grouping defined by the IEC (International Electrotechnical Commission) of the technical characteristics applicable to an electrical device to limit the risk of electrocution resulting from its failure.

- |     |  |  |
|-----|--|--|
| I   |  | Das Gehäuse dieser Geräte muss mittels eines getrennten Erdleiters an die Erdung angeschlossen sein /<br>These appliance must have their chassis connected to electrical earth by a separate earth conductor                 |
| II  |  | Diese Geräte sind so ausgelegt, dass kein Erdanschluss erforderlich ist /<br>These appliance are designed in such a way that it does not require a safety connection to electrical earth                                     |
| III |  | Diese Geräte sind darauf ausgelegt, von einer getrennten Sicherheitsstromquelle mit Kleinspannung versorgt zu werden /<br>These appliance are designed to be supplied from a separated/safety extra-low voltage power source |

Zertifizierung und Bestimmungen /  
Certification and regulations

- |  |   |
|--|---|
|  | Alle unsere Produkte sind zertifiziert und entsprechen den geltenden EG-Standards /<br>All our products comply with CE norms and current European standards                           |
|  | EMV - Europäische Richtlinie über die elektromagnetische Verträglichkeit /<br>EMC - European electromagnetic compatibility directive  |
|  | Dimmerbares Produkt /<br>Product dimmable   |
|  | Nicht dimmerbares Produkt /<br>Product not dimmable   |
|  | DALI - Digital Addressable Lighting Interface System zur Steuerung lichttechnischer Betriebsgeräte /<br>DALI - Digital Addressable Lighting Interface Domatic lighting control system |
|  | Größe quadratische Öffnung für Deckeneinbau /<br>Square cut-out size for ceiling recessed lamps   |
|  | Größe runde Öffnung für Deckeneinbau /<br>Round cut-out size for ceiling recessed lamps   |
|  | Größe quadratische Öffnung für Wandeinbau /<br>Square cut-out size for wall recessed lamps  |
|  | Größe runde Öffnung für Wandeinbau /<br>Round cut-out size for wall recessed lamps  |

# DALI

## DIGITAL ADDRESSABLE LIGHTING INTERFACE

System zur Steuerung  
lichttechnischer Betriebsgeräte /  
Domotic lightingh control system



Das Protokoll DALI (Digital Addressable Lighting Interface) stellt eine der innovativsten und modernsten Lösungen im Bereich der Beleuchtung dar. Da es darauf ausgelegt ist, eine flexible und individuelle Steuerung der Beleuchtungsanlagen zu bieten, gestattet es DALI, die Lichtquellen in einer Vielzahl von Umgebungen auf intelligente und harmonische Weise zu verwalten, von Büros und Geschäften bis zu öffentlichen Räumen und Wohngebäuden.

Das Protokoll DALI stellt eine wirkungsvolle Antwort auf moderne Beleuchtungslösungen dar, da es Technologie, Flexibilität und Nachhaltigkeit vereint. Da es in der Lage ist, sich verschiedenen Situationen anzupassen und die Energieeffizienz zu verbessern, kommt DALI die Rolle eines unverzichtbaren Verbündeten für Planer, Architekten und Endverbraucher zu, die nach intelligenten und individuell gestalteten Beleuchtungslösungen Ausschau halten. Sich für DALI zu entscheiden bedeutet, in eine leuchtende und nachhaltige Zukunft zu investieren.

Unsere Kollektion umfasst eine ganze Reihe von Lösungen, darunter elegante Einbauleuchten, Strahler für Schienensysteme, professionelle Leuchten, Driver und vieles mehr. Jedes Produkt wird aus hochwertigen Materialien hergestellt und mit den neuesten Technologien ausgestattet, um eine individuell anpassbare und dynamische Beleuchtung zu garantieren.

The DALI system (Digital Addressable Lighting Interface) represents one of the most innovative and advanced solutions in the field of lighting. Designed to offer flexible and customizable control of lighting installations, DALI allows for the intelligent and harmonious management of light sources in a variety of settings, from offices and shops to public and residential spaces.

The DALI system is an effective response to modern lighting needs, combining technology, flexibility, and sustainability. With its ability to adapt to different situations and improve energy efficiency, DALI positions itself as an indispensable ally for designers, architects, and end-users seeking intelligent and personalized lighting solutions. Choosing DALI means investing in a bright and sustainable future.

Our collection includes a variety of solutions, including elegant recessed fixtures, track lighting, professional lamps, drivers, and much more. Each product is made with high-quality materials and equipped with the latest technologies to ensure customizable and dynamic lighting.



**DALI**  
BRIGHTMAX  
220



**DALI**  
DRIVER  
415



**DALI**  
DRIVER DIMM  
420



**DALI**  
DRIVER ELG  
421



**DALI**  
DRIVER PWM  
422



**DALI**  
DRIVER DEL042  
423



**DALI**  
DIMMER  
428



**DALI**  
CONVERTERS  
429

Das System DALI kommt in einer Vielzahl von Situationen zum Einsatz /  
The DALI system finds application in a wide range of contexts.

**Gleich, ob sie einladende Atmosphären zu Hause erzeugen, die Beleuchtung von Büros optimieren oder gewerbliche Räume aufwerten möchten, unsere Produktpalette mit dem Protokoll DALI bietet die Flexibilität und Kontrolle, die für alle Ihre Wünsche erforderlich sind. Erkunden Sie die unendlichen Beleuchtungsmöglichkeiten, die unser Katalog zu bieten hat, und erfahren Sie, wie unsere Produkte Ihre Räume in außerordentliche Umgebungen verwandeln können.**

Whether you wish to create cozy atmospheres at home, optimize lighting in offices, or enhance commercial spaces, our DALI range offers the flexibility and control necessary to realize your vision. Explore the endless lighting possibilities that our catalog has to offer and discover how our products can transform your spaces into extraordinary environments.



#### **BÜROS:**

Schaffung von angenehmen und produktiven Arbeitsumgebungen anhand adaptiver Beleuchtung.

#### **OFFICES:**

creating comfortable and productive work environments through adaptive lighting.



#### **GESCHÄFTE UND SHOWROOMS:**

Möglichkeit der Hervorhebung von Produkten und Räumen durch strategische Beleuchtungsszenarien.

#### **STORES AND SHOWROOMS:**

the ability to highlight products and spaces with strategic lighting scenarios.



#### **ÖFFENTLICHE RÄUME:**

Beleuchtung von öffentlichen Bereichen auf sichere und einladende Weise unter Verbesserung der Besuchererfahrung.

#### **PUBLIC SPACES:**

safely and warmly illuminate public areas, enhancing the visitor experience.



#### **WOHNGEBÄUDE:**

Individuell gestaltete Beleuchtungslösungen zur Verbesserung von Komfort und Ästhetik von Wohnumgebungen.

#### **RESIDENTIAL:**

customized lighting solutions to improve the comfort and aesthetics of home environments.

## DALI, Haupteigenschaften / DALI, main features

### **1. Digitale Adressierbarkeit**

Jedes DALI-Gerät kann einzeln adressiert werden und gestattet so eine präzise Steuerung jedes Geräts. Dies gestattet es, individuell gestaltete Beleuchtungsszenarien zu schaffen und die Beleuchtungsstärke bereichsspezifisch zu steuern.

### **2. Mühelose Installation und Konfiguration**

Das System DALI verwendet eine einfache und standardisierte Verkabelung und senkt so die Installationskosten und vereinfacht die Konfiguration. Die Möglichkeit, bis zu 64 Geräte an einen einzigen Bus anzuschließen, macht DALI extrem skalierbar.

### **3. Interoperabilität.**

DALI ist ein offener Standard, was bedeutet, dass die Geräte verschiedener Hersteller problemlos zusammen betrieben werden können. Dies bietet den Benutzern die Freiheit, die für ihre jeweiligen Anforderungen am besten geeigneten Komponenten zu wählen.

### **4. Hochmoderne Steuerung**

Mit DALI ist es möglich, hochmoderne Steuerungsfunktionen zu implementieren, wie Dimmer, Programmierung von Szenarien und Synchronisation mehrerer Geräte. Dies gestattet es, die Beleuchtung abhängig von den spezifischen Anforderungen der Benutzer und Umgebungsbedingungen zu optimieren.

### **1. Digital Addressability.**

Each DALI device can be individually addressed, allowing precise control of each unit. This enables the creation of customized lighting scenarios and the ability to manage light intensity specifically for each area.

### **2. Ease of Installation and Configuration.**

The DALI system utilizes simple, standardized wiring, reducing installation costs and simplifying configuration. The ability to connect up to 64 devices on a single bus makes DALI highly scalable.

### **3. Interoperability.**

DALI is an open standard, meaning devices from different manufacturers can work together seamlessly. This offers users the freedom to choose the components that best meet their needs.

### **4. Advanced Control.**

With DALI, it is possible to implement advanced control functions, such as dimming, scenario programming, and synchronization between multiple devices. This allows for optimizing lighting according to specific user requirements and environmental conditions.

VERZEICHNIS NACH KATEGORIE /  
INDEX BY CATEGORY

- 026 **Wandleuchten /  
Wall lamps**
- 128 **Deckenleuchten /  
Ceiling lamps**
- 160 **Kombinierte wand-, Hänge- und bodenleuchten /  
Wall, suspension and floor lamps combined**
- 250 **Aufladbare Tischleuchten /  
Rechargeable table lamps**
- 264 **Einbau- und Orientierungsleuchten /  
Inground and walk lights**
- 306 **Solarleuchten /  
Solar lamps**
- 318 **Flutlichtleuchten /  
Flood lights**
- 352 **Strassenleuchten /  
Street lights**
- 372 **Easy  
Domotic 24V**
- 382 **Technische DMX-Dekorleuchten /  
DMX Technical Decoration Lighting**
- 410 **Beleuchtungskomponenten /  
Lighting Components**

Outdoor  
**Wandleuchten /**  
**Wall lamps**

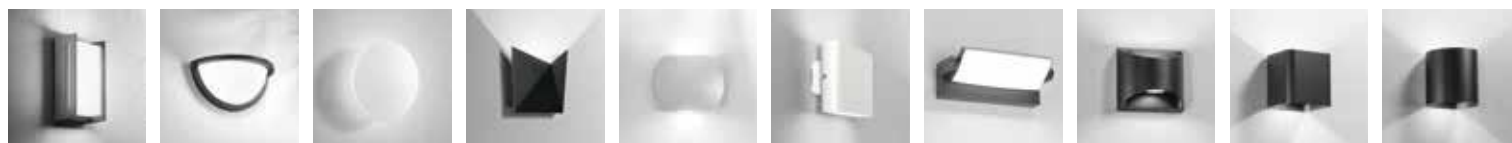

COMPACT 28    DETROIT 29    ZODIAC 30    STEALTH 32    MIURA 34    GAMMA 35    FLOYD 36    VEYRON 38    BIOME 40    GOLF 42

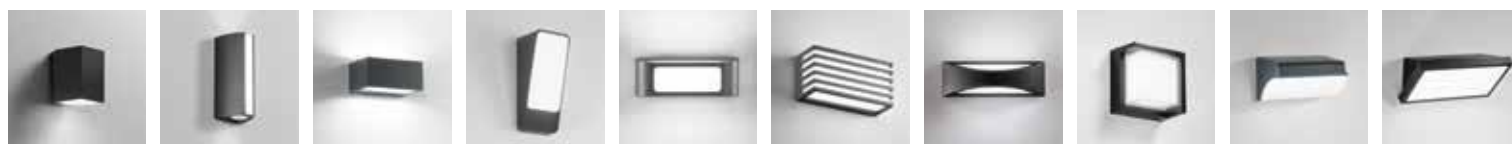

POLO 44    RAY 46    TWIN 48-51    COUPE 52    DESERT 54    DUKROT 56    WEISS 58    BLOCK 60    BORDER 62    RIM 64

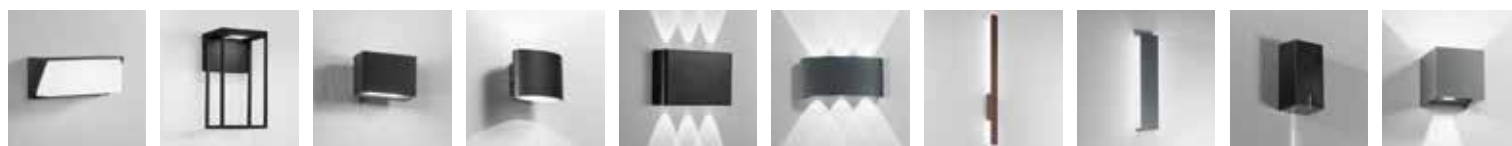

LUXON 66    GRIS 68    AGERA 70    BOXTER 72    KLEIN 74    BEETLE 76    HERCULES 78    RIBBON 80    LASER 82    ALFA 84-87



DELTA 88    PARKER 90-93    PORTLAND 94    OAKLAND 95    JUMP 96    ROSEN 98    ONE 100    QUBO 102    POPUP 104    TUCSON 106

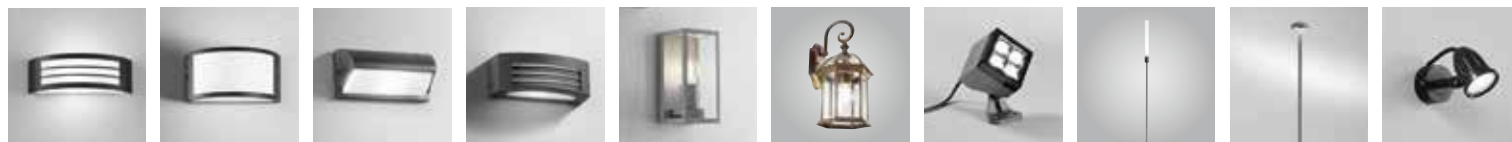

SOLIX 108    AUSTIN 110    ATLANTA 112    DENVER 113    MONDRIAN 114    GAETA 115    PAVÉ 116    WAX 118    PUCK 120    PEG 122



HAYDON 123    GRUBB 124    AKRON 125    DROP 126

Outdoor  
**Deckenleuchten /  
 Ceiling lamps**

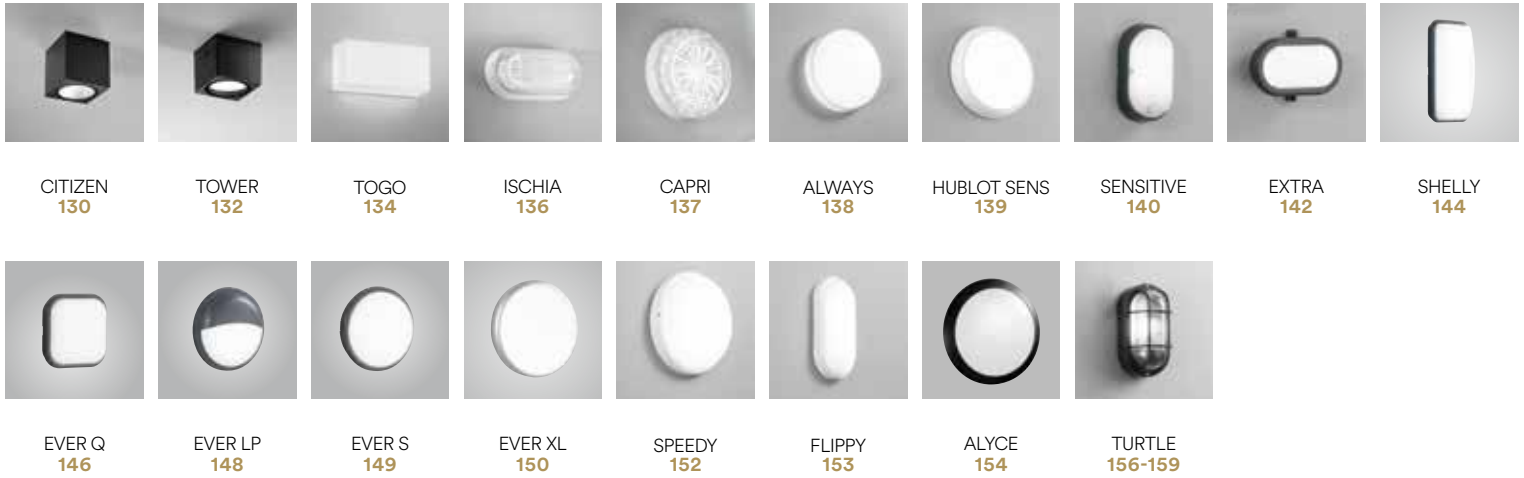

Outdoor  
**Kombinierte wand-, Hänge- und bodenleuchten /  
 Wall, suspension and floor lamps combined**

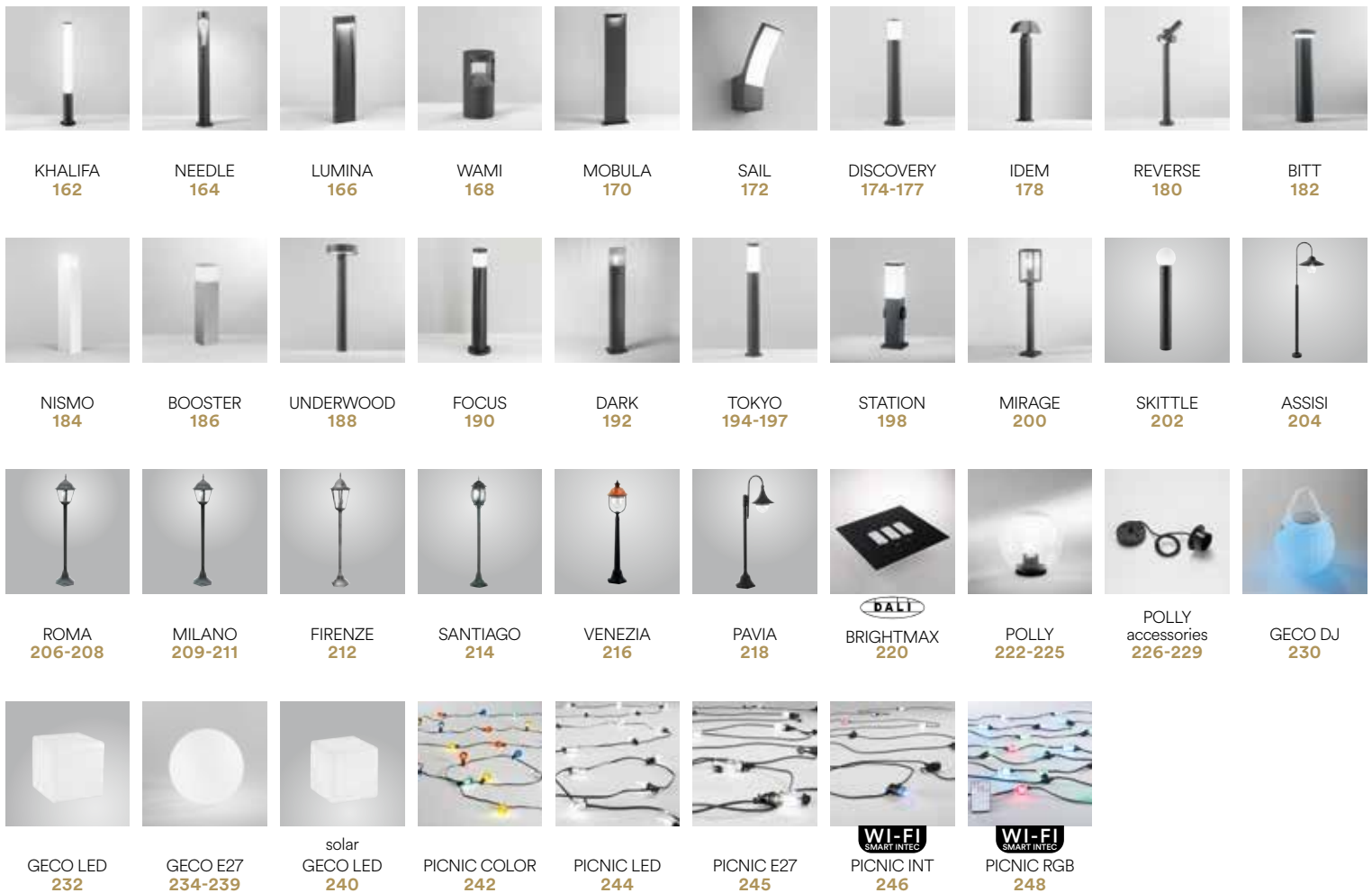

Outdoor

**Aufladbare Tischleuchten /  
Rechargeable table lamps**COCKTAIL  
256JIN  
258-261ROBIN  
262

Outdoor

**Einbau- und Orientierungsleuchten /  
Inground and walk lights**RIDER  
266-268BARRET  
269SUBWAY  
270EASY  
DOMOTICA  
IMPACT  
271EASY  
DOMOTICA  
STEP  
272ELMO  
274WALK  
276-279DECK  
280GROUND  
282HUMMER  
284DRIVE  
286OASIS  
288STEPLIGHT  
290SHELBY  
291ONYX  
292STRATOS  
294-297SLAB  
298BREEN  
300SMILE  
302BOLT  
304

Outdoor

**Solarleuchten /  
Solar lamps**MAEVE  
308GIZAH  
310IRIS  
312NASA  
313GLASER  
314LUXOR  
316

Outdoor  
**Flutlichtleuchten /  
 Flood lights**



BANNER  
320

SAT  
322

ESUS  
324-327

ESUS SENSOR  
328

ESUS PORTABLE  
329

AXEL  
330-333

AXEL SENSOR  
334

AXEL PORTABLE  
335

BULL  
336

KNOX  
338



ATHOS  
340

FLOOD LIGHTS  
accessories  
343

GIOVE  
344-347

MASTER  
348

ENERGY  
350

Outdoor  
**Strassenleuchten /  
 Street lights**



AUREUS  
354

RADIUS  
356

FEBO  
358

IPERION  
360

ROADWAY  
362

STREETWAY  
364

HIGHWAY  
366

EXPO  
368

VILLA  
370

Decorative  
**Easy Domotic 24V**



EASY DOMOTICA 24V

TARGET  
375

EASY DOMOTICA 24V

AGILITY  
376

EASY DOMOTICA 24V

QUICK  
378

EASY DOMOTICA 24V

SPRINT  
380

EASY DOMOTICA 24V

RUNNER  
381

Decorative

**Technische DMX-Dekorleuchten /  
DMX Technical Decoration Lighting**



**WI-FI**  
SMART INTEC  
SHOW WALLWASHER  
384



**WI-FI**  
SMART INTEC  
SHOW PAR  
386



**WI-FI**  
SMART INTEC  
SHOW Q  
388



**WI-FI**  
SMART INTEC  
SHOW TUBE  
390



RAYS  
392



WALLWASHER  
394



IRIDE  
396

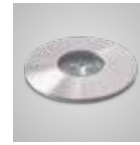

IRIDE R  
399



NEPTUNE  
400



CROWN  
401



TREVIS  
402



PAR56  
404



PELPS  
405



CONTROLLER  
406-409

Zubehör / Accessories

**Beleuchtungskomponenten /  
Lighting components**



COMPONENTS  
accessories  
413



DRIVER  
MINI and LT  
414



DRIVER  
LT 24V  
414-415



**DALI**  
DRIVER  
415



DRIVER  
LT 24V 2  
416

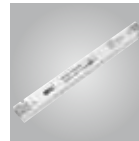

DRIVER  
LT 48V  
416



POWER SUPPLY  
LRS and RSP  
417-419



DRIVER  
LPHC-LPH-LCM  
420



**DALI**  
DRIVER DIMM  
420



DRIVER  
HLG  
420



DRIVER  
ELG  
421



**DALI**  
DRIVER ELG  
421

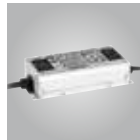

DRIVER  
XLG  
422



**DALI**  
DRIVER PWM  
422



DRIVER  
HDR-NDR-SDR  
423



**DALI**  
DRIVER DEL042  
423



DRIVER  
424-425



DIMMER  
426



EMERGENCY  
DRIVER  
427



DIMMER  
for Strip Led  
428



**DALI**  
DIMMER  
428



CONVERTERS  
429



**DALI**  
CONVERTERS  
429



REMOTE  
CONTROLS  
430-435



SPI  
CONTROLLER  
436-439



SENSORS  
440-441

# ALPHABETISCHES VERZEICHNIS / ALPHABETICAL INDEX

Artikel / article	Seite / page
AGERA	70
AGILITY Easy Domotica 24V	376
AKRON	125
ALFA	84-87
ALWAYS	138
ALYCE	154
ASSISI	204
ATHOS	340
ATLANTA	112
AUREUS	354
AUSTIN	110
AXEL	330-333
AXEL PORTABLE	335
AXEL SENSOR	334
BANNER	320
BARRET	269
BEETLE	76
BIOME	40
BITT	182
BLOCK	60
BOLT	304
BOOSTER	186
BORDER	62
BOXTER	72
BREEN	300
BRIGHTMAX	220
BULL	336
CAPRI	137
CITIZEN	130
COCKTAIL	256
COMPACT	28
CONTROLLER DMX Technical Decoration Lighting	406-409

Artikel / article	Seite / page
CONVERTERS Lighting Components	429
COUPE	52
CROWN	401
DARK	192
DECK	280
DELTA	88
DENVER	113
DESERT	54
DETROIT	29
DIMMER Lighting Components	426, 428
DISCOVERY	174-177
DRIVE	286
DRIVER Lighting Components	414-416, 420-425, 427
DROP	126
DUKROT	56
ELMO	274
ENERGY	350
ESUS	324- 327
ESUS PORTABLE	329
ESUS SENSOR	328
EVER	146-151
EXPO	368
EXTRA	142
FEBO	358
FIRENZE	212
FLIPPY	153
FLOOD LIGHTS Accessories	343
FLOYD	36
FOCUS	190

Artikel / article	Seite / page
GAETA	115
GAMMA	35
GECO DJ	230
GECO E27	234-239
GECO LED	232
GECO LED SOLAR	240
GIOVE	344 -347
GIZAH	310
GLASER	314
GOLF	42
GRIS	68
GROUND	282
GRUBB	124
HAYDON	123
HERCULES	78
HIGHWAY	366
HUBLOT SENS	139
HUMMER	284
IDEM	178
IMPACT	271
IPERION	360
IRIDE	396-399
IRIS	312
ISCHIA	136
JIN	258-261
JUMP	96
KHALIFA	162
KLEIN	74
KNOX	338
LASER	82
LUMINA	166
LUXON	66
LUXOR	316
MAEVE	308

Artikel / article	Seite / page
<b>MASTER</b>	<b>348</b>
<b>MILANO</b>	<b>209-211</b>
<b>MIRAGE</b>	<b>200</b>
<b>MIURA</b>	<b>34</b>
<b>MOBULA</b>	<b>170</b>
<b>MONDRIAN</b>	<b>114</b>
<b>NASA</b>	<b>313</b>
<b>NEEDLE</b>	<b>164</b>
<b>NEPTUNE</b>	<b>400</b>
<b>NISMO</b>	<b>184</b>
<b>OAKLAND</b>	<b>95</b>
<b>OASIS</b>	<b>288</b>
<b>ONE</b>	<b>100</b>
<b>ONYX</b>	<b>292</b>
<b>PAR56</b>	<b>404</b>
<b>PARKER</b>	<b>90-93</b>
<b>PAVÈ</b>	<b>116</b>
<b>PAVIA</b>	<b>218</b>
<b>PEG</b>	<b>122</b>
<b>PELPS</b>	<b>405</b>
<b>PICNIC</b>	<b>244</b>
<b>PICNIC COLOR</b>	<b>242</b>
<b>PICNIC INT</b>	<b>246</b>
<b>PICNIC RGB</b>	<b>248</b>
<b>POLLY</b>	<b>222-225</b>
<b>POLLY Accessories</b>	<b>226-229</b>
<b>POLO</b>	<b>44</b>
<b>POPOP</b>	<b>104</b>
<b>PORTLAND</b>	<b>94</b>
<b>POWER SUPPLY Lighting Components</b>	<b>417-419</b>
<b>PUCK</b>	<b>120</b>
<b>QUBO</b>	<b>102</b>

Artikel / article	Seite / page
<b>QUICK Easy Domotica 24V</b>	<b>378</b>
<b>RADIUS</b>	<b>356</b>
<b>RAY</b>	<b>46</b>
<b>RAYS</b>	<b>392</b>
<b>REMOTE CONTROL Lighting Components</b>	<b>430-435</b>
<b>REVERSE</b>	<b>180</b>
<b>RIBBON</b>	<b>80</b>
<b>RIDER</b>	<b>266-268</b>
<b>RIM</b>	<b>64</b>
<b>ROADWAY</b>	<b>362</b>
<b>ROBIN</b>	<b>262</b>
<b>ROMA</b>	<b>206-208</b>
<b>ROSEN</b>	<b>98</b>
<b>RUNNER Easy Domotica 24V</b>	<b>381</b>
<b>SAIL</b>	<b>172</b>
<b>SANTIAGO</b>	<b>214</b>
<b>SAT</b>	<b>322</b>
<b>SENSITIVE</b>	<b>140</b>
<b>SENSORS Lighting Components</b>	<b>440-441</b>
<b>SHELBY</b>	<b>291</b>
<b>SHELLY</b>	<b>144</b>
<b>SHOW PAR</b>	<b>386</b>
<b>SHOW Q</b>	<b>388</b>
<b>SHOW TUBE</b>	<b>390</b>
<b>SHOW WALLWASHER</b>	<b>384</b>
<b>SKITTLE</b>	<b>202</b>
<b>SLAB</b>	<b>298</b>
<b>SMILE</b>	<b>302</b>
<b>SOLIX</b>	<b>108</b>
<b>SPEEDY</b>	<b>152</b>

Artikel / article	Seite / page
<b>SPI CONTROLLER Lighting Components</b>	<b>436-439</b>
<b>SPRINT Easy Domotica 24V</b>	<b>380</b>
<b>STATION</b>	<b>198</b>
<b>STEALTH</b>	<b>32</b>
<b>STEP</b>	<b>272</b>
<b>STEPLIGHT</b>	<b>290</b>
<b>STRATOS</b>	<b>294-297</b>
<b>STREETWAY</b>	<b>364</b>
<b>SUBWAY</b>	<b>270</b>
<b>TARGET Easy Domotica 24V</b>	<b>375</b>
<b>TOGO</b>	<b>134</b>
<b>TOKYO</b>	<b>194-197</b>
<b>TOWER</b>	<b>132</b>
<b>TREVIS</b>	<b>402</b>
<b>TUCSON</b>	<b>106</b>
<b>TURTLE</b>	<b>156-159</b>
<b>TWIN</b>	<b>48-51</b>
<b>UNDERWOOD</b>	<b>188</b>
<b>VENEZIA</b>	<b>216</b>
<b>VEYRON</b>	<b>38</b>
<b>VILLA</b>	<b>370</b>
<b>WALK</b>	<b>276-279</b>
<b>WALLWASHER</b>	<b>394</b>
<b>WAMI</b>	<b>168</b>
<b>WAX</b>	<b>118</b>
<b>WEISS</b>	<b>58</b>
<b>ZODIAC</b>	<b>30</b>





**Wandlampen / Wall lamps**  
outdoor

# COMPACT

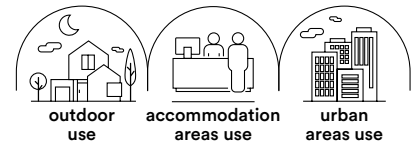

**LED-Wandleuchte mit Diffusor aus Polycarbonat und anthrazitfarbenem Aluminiumgehäuse. Artikel für Innen- und Außenbereiche mit Schutz gegen Festkörper und Flüssigkeiten, hoher Stoßfestigkeit und Einstellung der Lichttemperatur.**

LED wall lamp with polycarbonate diffuser and anthracite aluminium fixture. A product for indoor and outdoor use with protection against solid objects and liquids, high impact resistance and light temperature adjustment.

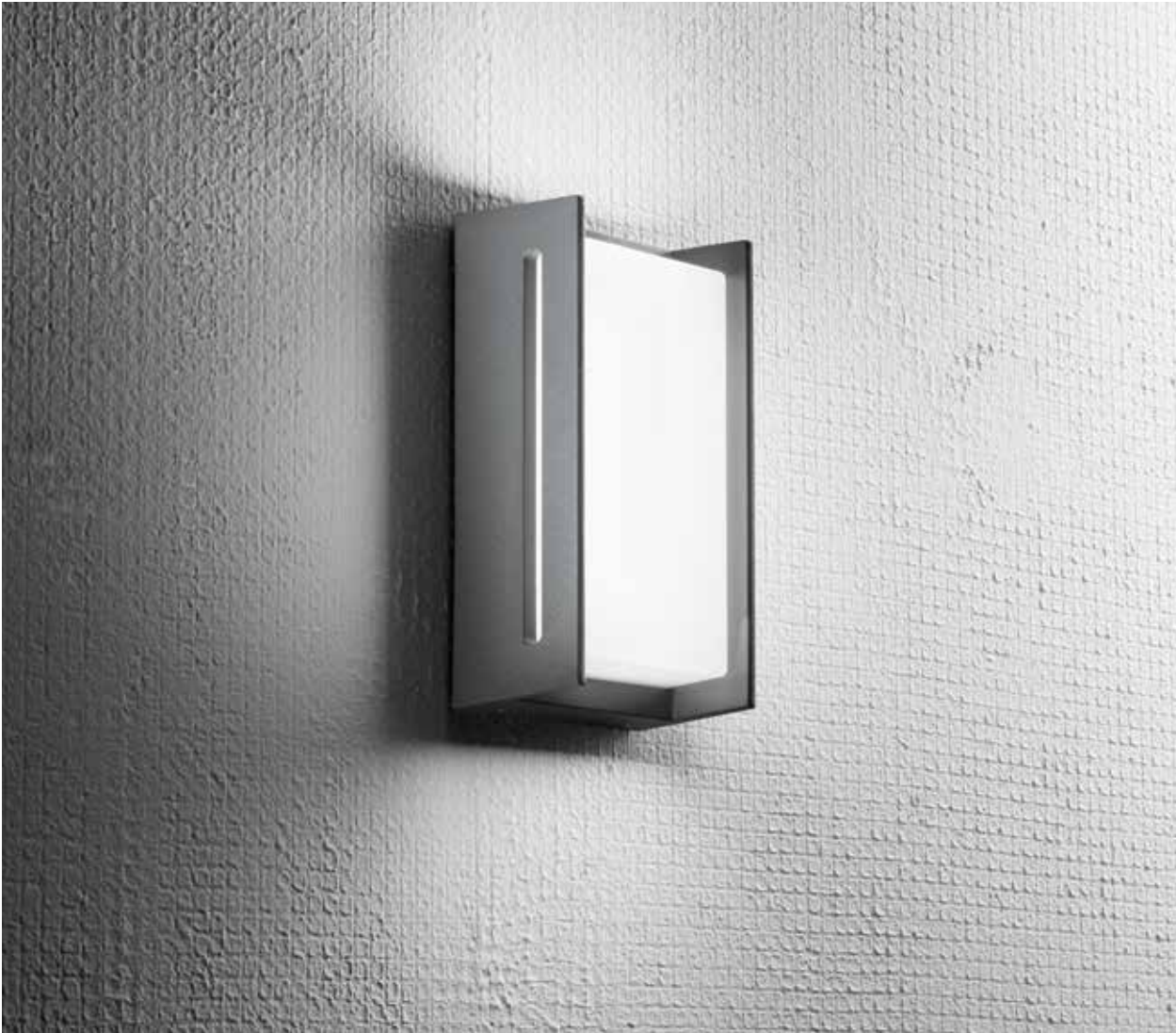

**Material**

Aluminium + Polycarbonat

**Farbe**

Anthrazit



**Wählbare Farbtemperatur**  
3000K / 4000K



**Driver**  
inklusive

**Material**

aluminum + polycarbonate

**Colour**

anthracite



**Selectable color temperature**  
3000K / 4000K



**Driver**  
included



**LED-W-COMPACT**

8031414867110  
FANEU00007728  
lumen

colour temp.



2260 lm

watt 18W  
beam angle 120°

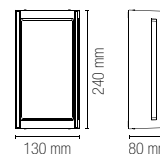

# DETROIT

LED-Wandleuchte mit schwarzem Aluminiumgehäuse und Diffusor aus Polycarbonat. Aus hochfesten Materialien hergestellt, bietet zwei Farbtemperaturen mit hervorragender Farbwiedergabe.

LED wall lamp with black aluminium fixture and polycarbonate diffuser. Made of highly resistant materials, it features two colour temperatures with excellent colour rendering.



In.tec light WANDLAMPEN / WALL LAMPS

**Material**

Aluminium + Polycarbonat

**Material**

aluminum + polycarbonate

**Farbe**

schwarz

**Colour**

black



**Wählbare Farbtemperatur**  
3000K / 4000K



**Selectable color temperature**  
3000K / 4000K



**Driver**

inklusive

**Driver**

included



**LED-W-DETROIT-AP**

8031414862290  
FANEU00007748  
lumen

colour temp. | colour



1320 lm

watt 10W  
beam angle 120°

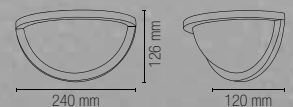



outdoor  
use

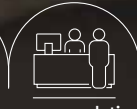

accommodation  
areas use



urban  
areas use



**LED-Beleuchtung auf 360°, Gehäuse aus weißem oder schwarzem Polycarbonat. Aus korrosionsfesten Materialien hergestellt, garantiert Zodiac einen hohen Schutz gegen Festkörper und Flüssigkeiten, einstellbare Farbtemperatur und hervorragende Farbwiedergabe.**

360° LED lighting, white or black polycarbonate fixture. Made of anti-corrosive materials, Zodiac guarantees high protection against solid objects and liquids, adjustable colour temperature and excellent colour rendering.

- Material**  
PC

---

- Farbe**  
Weiß  
Schwarz
- 

---

- Wählbare Farbtemperatur**  
3000K / 4000K
- 

---

- Driver**  
eingebaut

---

- Material**  
PC

---

- Colour**  
white  
black
- 

---

- Selectable color temperature**  
3000K / 4000K
- 

---

- Driver**  
built-in

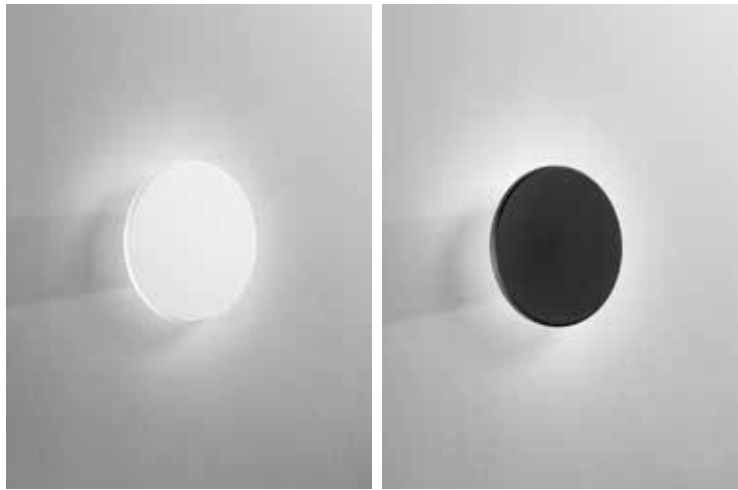

	colour temp.	colour
<b>LED-W-ZODIAC-M-BCO</b> 8031414889846 FANEU00007875 lumen	<span style="display: inline-block; width: 10px; height: 10px; background-color: yellow; border: 1px solid black; margin-right: 5px;"></span> <span style="display: inline-block; width: 10px; height: 10px; background-color: grey; border: 1px solid black; margin-left: 5px;"></span>	<span style="display: inline-block; width: 10px; height: 10px; background-color: white; border: 1px solid black; margin-right: 5px;"></span>
	1550 lm	
<b>LED-W-ZODIAC-M-NER</b> 8031414889853 FANEU00007876 lumen	<span style="display: inline-block; width: 10px; height: 10px; background-color: yellow; border: 1px solid black; margin-right: 5px;"></span> <span style="display: inline-block; width: 10px; height: 10px; background-color: grey; border: 1px solid black; margin-left: 5px;"></span> <span style="display: inline-block; width: 10px; height: 10px; background-color: black; border: 1px solid black; margin-left: 15px;"></span>	
	1550 lm	
watt	12W	
beam angle	360°	

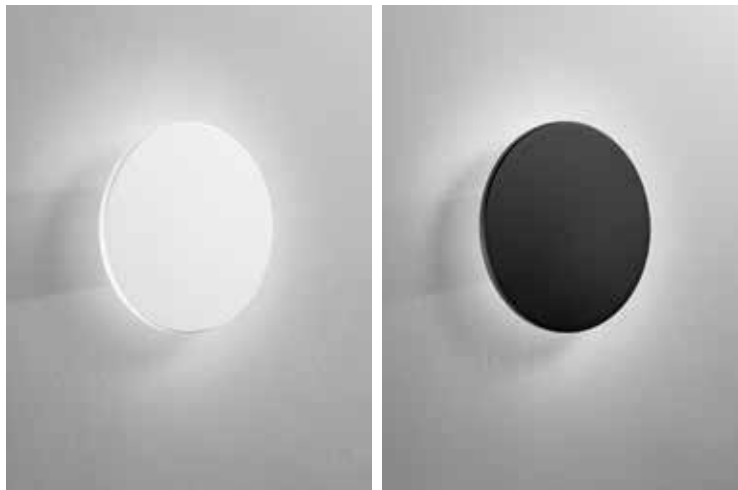

	colour temp.	colour
<b>LED-W-ZODIAC-L-BCO</b> 8031414889860 FANEU00007873 lumen	<span style="display: inline-block; width: 10px; height: 10px; background-color: yellow; border: 1px solid black; margin-right: 5px;"></span> <span style="display: inline-block; width: 10px; height: 10px; background-color: grey; border: 1px solid black; margin-left: 5px;"></span>	<span style="display: inline-block; width: 10px; height: 10px; background-color: white; border: 1px solid black; margin-right: 5px;"></span>
	2450 lm	
<b>LED-W-ZODIAC-L-NER</b> 8031414889877 FANEU00007874 lumen	<span style="display: inline-block; width: 10px; height: 10px; background-color: yellow; border: 1px solid black; margin-right: 5px;"></span> <span style="display: inline-block; width: 10px; height: 10px; background-color: grey; border: 1px solid black; margin-left: 5px;"></span> <span style="display: inline-block; width: 10px; height: 10px; background-color: black; border: 1px solid black; margin-left: 15px;"></span>	
	2450 lm	
watt	18W	
beam angle	360°	

# STEALTH

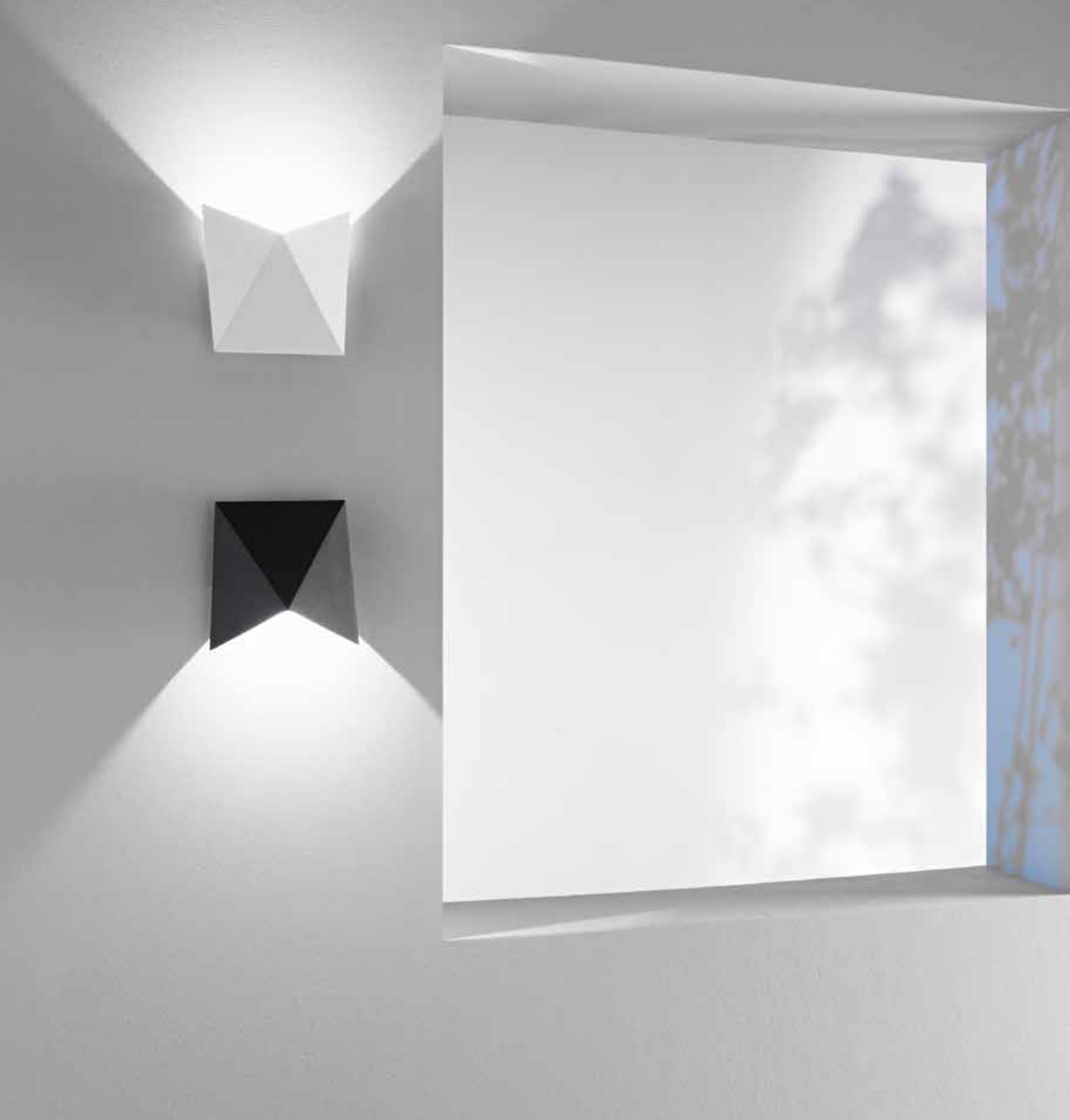



**LED-Wandleuchte aus geprägtem Aluminium, erhältlich in den Farbtönen Weiß oder Schwarz. Das unvergängliche Profil macht sie ideal für Innen- und Außenbereiche sowie für den Einsatz in Beherbergungsbetrieben und städtischen Umgebungen.**

LED wall lamp in embossed aluminium available in white or black. Its iconic profile makes it ideal for indoor and outdoor spaces, such as hospitality facilities and urban areas.

- Material**  
Aluminium

---

- Farbe**  
Geprägt, Weiß  
Geprägt, Schwarz
- 

---

- Wählbare Farbtemperatur**  
3000K / 4000K
- 

---

- Driver**  
inklusive

---

- Material**  
aluminium

---

- Colour**  
embossed white  
embossed black
- 

---

- Selectable color temperature**  
3000K / 4000K
- 

---

- Driver**  
included

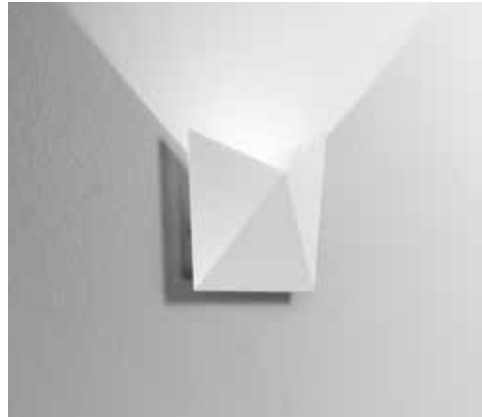

	colour temp.	colour
<b>LED-W-STEALTH BCO</b>		
8031414866960		
FANEU00007841		
lumen	580 lm	

watt	6W
beam angle	120°

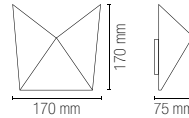

	colour temp.	colour
<b>LED-W-STEALTH NER</b>		
8031414866953		
FANEU00007842		
lumen	580 lm	

watt	6W
beam angle	120°

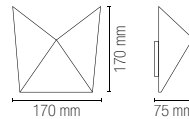

# MIURA

Minimalistisches Design, das in dem extrem schmalen Profil des Gehäuses aus geprägtem weißem Aluminium und einem sanften doppelten Lichtstrahl zum Ausdruck kommt. Mit hocheffizienter LED, zwei Farbtemperaturen und hervorragender Farbwiedergabe.

Minimalist design achieved with the ultra-thin profile of the white embossed aluminium fixture and subtle dual emission. With high-efficiency LED, dual colour temperatures and excellent colour rendering.



**Material**

Aluminium

**Farbe**

Geprägt, Weiß



**Wählbare Farbtemperatur**  
3000K / 4000K



**Driver**  
inklusive

**Material**

aluminium

**Colour**

embossed white



**Selectable color temperature**  
3000K / 4000K



**Driver**  
included



**LED-W-MIURA/6W**

8031440351447  
FANEU00007803  
lumen

colour temp.



520 lm

watt  
beam angle

2 × 3W  
↓ 110° + 110° ↑

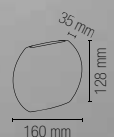

# GAMMA

Gamma besteht vollkommen aus Aluminium und zeichnet sich durch die weichen Linien des Frontgehäuses und das weiße geprägte Finish aus. Mit warmem und neutralem Lichtfarbton, um Außenbereiche in der Stadt oder in Wohngebieten zu beleuchten und zu gestalten.

Made entirely of aluminium, Gamma is striking with the smooth lines of its front fixture and white embossed finish. With warm and neutral colour temperatures to illuminate and decorate urban or residential outdoor spaces.



In.tec light WANDLAMPEN / WALL LAMPS

**Material**  
Aluminium

**Material**  
aluminium

**Farbe**  
Geprägt, Weiß

**Colour**  
embossed white



**Wählbare Farbtemperatur**  
3000K / 4000K

**Selectable color temperature**  
3000K / 4000K



**Driver**  
inklusive

**Driver**  
included



**LED-W-GAMMA/10W**

8031434041217  
FANEU00007769  
lumen

colour temp. | colour



1100 lm

watt  
beam angle

2 × 5W  
↓ 120° + 120° ↑

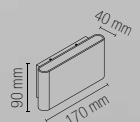

# FLOYD

In Mattweiß oder in elegantem Anthrazit verbindet Floyd den ästhetischen Blickfang mit der Zweckmäßigkeit des verstellbaren Diffusors. Mit hervorragenden technischen Spezifikationen für maximale Lebensdauer und Beständigkeit in Außenumgebungen.

Floyd, in matt white or sophisticated anthracite, combines aesthetic appeal with a practical adjustable diffuser. With excellent technical specifications for maximum durability and resistance in outdoor environments.





**Material**

Aluminium + PC

**Farbe**

Mattweiß  
Anthrazit



**Wählbare  
Farbtemperatur**

2700K / 3300K / 4000K



**Driver**

inklusive

**Material**

aluminum + PC

**Colour**

matt white  
anthracite



**Selectable color  
temperature**

2700K / 3300K / 4000K



**Driver**

included

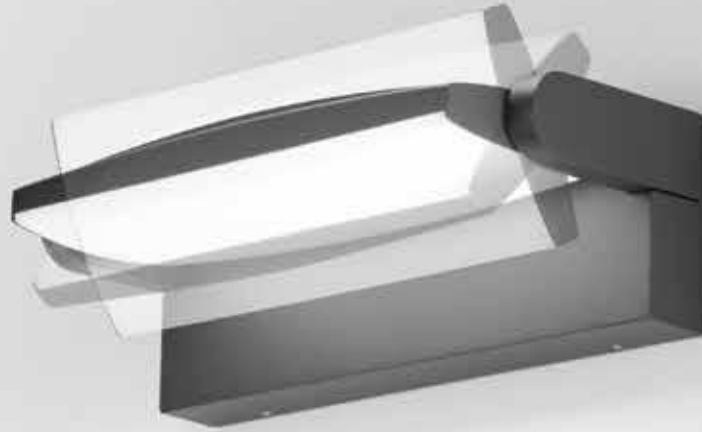

**LED-FLOYD-AP-BCO**

8031414931460  
FANEU00027332  
lumen

colour temp.	colour
3300 lm	

**LED-FLOYD-AP-ANT**

8031414931521  
FANEU00027331  
lumen

colour temp.	colour
3300 lm	

watt	25W
beam angle	100°

watt	25W
beam angle	100°

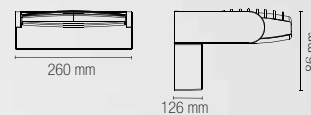
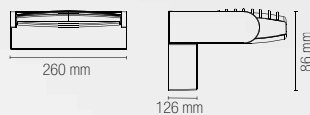

# VEYRON





**LED-Wandleuchte aus geprägtem Aluminium in Weiß oder Schwarz. Mit doppeltem Lichtstrahl, doppelter Farbtemperatur und hoher Farbwiedergabe, für eine gleichermaßen technische wie ästhetische Beleuchtung.**

LED wall lamp in black or white embossed aluminium. It features dual emission, dual colour temperature and high colour rendering, for a technical and aesthetic lighting solution.

**Material**

Aluminium

**Farbe**

Geprägt, Weiß  
Geprägt, Schwarz



**Wählbare Farbtemperatur**

3000K / 4000K



**Driver**

inklusive

**Material**

aluminium

**Colour**

embossed white  
embossed black



**Selectable color temperature**

3000K / 4000K



**Driver**

included



**LED-W-VEYRON BCO**

8031440361163  
FANEU00007864  
lumen

colour temp. | colour



840 lm

watt  $2 \times 3,5W$   
beam angle  $\downarrow 120^\circ + 120^\circ \uparrow$

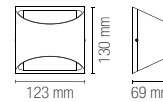

**LED-W-VEYRON NERO**

8031440361095  
FANEU00007865  
lumen

colour temp. | colour



840 lm

watt  $2 \times 3,5W$   
beam angle  $\downarrow 120^\circ + 120^\circ \uparrow$

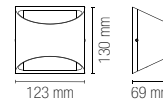

# BIOME

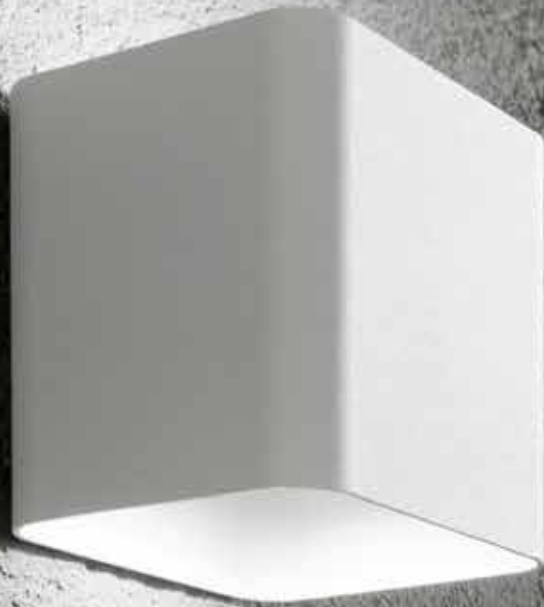



**COB-LED-Wandleuchte mit hervorragender Farbwiedergabe. Durch das geprägte Aluminium findet sie ihren Platz in modernen Außenbereichen, Wohngebieten mit minimalistischem Design oder als dekoratives Detail in städtischen Umgebungen.**

COB LED wall lamp with excellent colour rendering. Made of embossed aluminium, it is perfect for modern outdoor spaces, minimalist residential areas or as a decorative detail in urban areas.

**Material**

Aluminium

**Farbe**Geprägt, Weiß  
Geprägt, Schwarz**Wählbare Farbtemperatur**

3000K / 4000K

**Driver**

inklusive

**Material**

aluminium

**Colour**embossed white  
embossed black**Selectable color temperature**

3000K / 4000K

**Driver**

included

**LED-W-BIOME BCO**

8031440361125

FANEU00007714

lumen

colour temp.



840 lm

watt

2 x 3,5W

beam angle

↓ 120° + 120° ↑

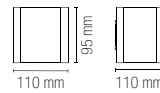
**LED-W-BIOME NERO**

8031440361132

FANEU00007715

lumen

colour temp.



840 lm

watt

2 x 3,5W

beam angle

↓ 120° + 120° ↑

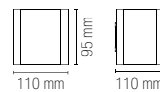

# GOLF





**Essenziell, doch mit Klasse. Golf bietet einen doppelten Lichtstrahl mit COB-LED in Kombination mit dem Aluminiumgehäuse mit geprägtem Finish.**

**Zwei Farbtemperaturen für eine optimale Farbtreue.**

Minimalist yet sophisticated. Golf features COB LED dual emission combined with an aluminium fixture with an embossed finish. Dual colour temperatures for optimum colour fidelity.

#### Material

Aluminium

#### Farbe

Geprägt, Weiß  
Geprägt, Schwarz



#### Wählbare Farbtemperatur

3000K / 4000K



#### Driver

inklusive

#### Material

aluminium

#### Colour

embossed white  
embossed black



#### Selectable color temperature

3000K / 4000K



#### Driver

included



#### LED-W-GOLF BCO

8031440361101

FANEU00007772

lumen

colour temp.

colour



840 lm

watt

2 × 3,5W

beam angle

↓ 120° + 120° ↑

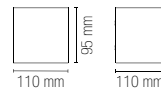

#### LED-W-GOLF NERO

8031440361118

FANEU00007773

lumen

colour temp.

colour



840 lm

watt

2 × 3,5W

beam angle

↓ 120° + 120° ↑

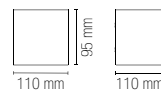

# POLO



**Material**  
PC

**Farbe**  
Weiß  
Schwarz



**Wählbare  
Farbtemperatur**  
3000K / 4000K



**Driver**  
inklusive

**Material**  
PC

**Colour**  
white  
black



**Selectable color  
temperature**  
3000K / 4000K



**Driver**  
included





**LED-Wandleuchte aus Polycarbonat mit einzelner oder doppelter Lichtstrahl, erhältlich in Weiß oder Mattschwarz. Der Artikel verfügt über korrosionsabweisende Eigenschaften und hohen Schutz vor Staub und Wasserstrahlen.**

LED wall lamp in polycarbonate with single or dual emission, available in matt black or white. The product has anti-corrosive properties and provides high protection against dust and water jets.

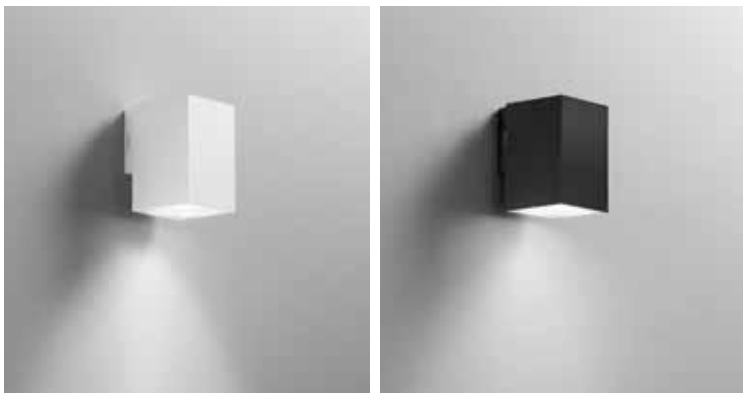

	colour temp.	colour	
<b>LED-W-POLO-Q1-BCO</b> 8031414889655 FANEU00007818 lumen			
	980 lm		
<b>LED-W-POLO-Q1-NER</b> 8031414889662 FANEU00007819 lumen			
	980 lm		
watt	8W		
beam angle	60°		

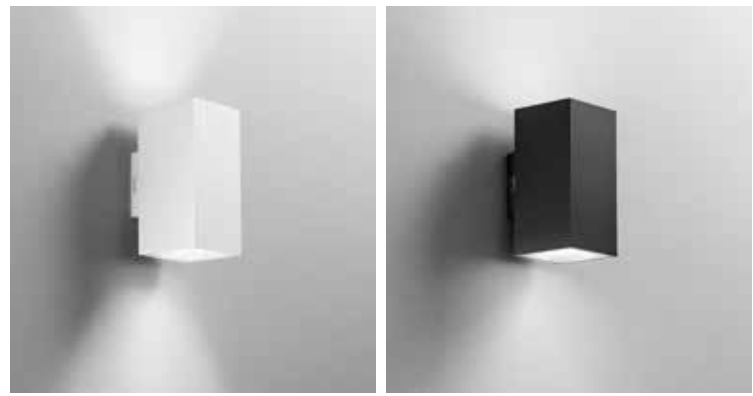

	colour temp.	colour	
<b>LED-W-POLO-Q2-BCO</b> 8031414889679 FANEU00007820 lumen			
	1960 lm		
<b>LED-W-POLO-Q2-NER</b> 8031414889686 FANEU00007821 lumen			
	1960 lm		
watt	2 x 8W		
beam angle	↓ 60° + 60° ↑		

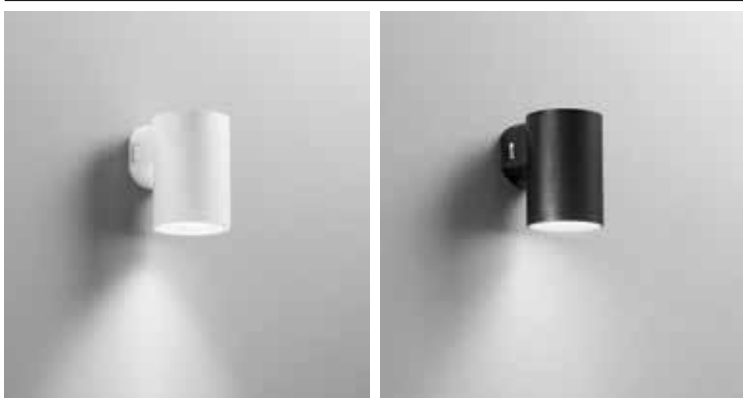

	colour temp.	colour	
<b>LED-W-POLO-R1-BCO</b> 8031414889617 FANEU00007822 lumen			
	980 lm		
<b>LED-W-POLO-R1-NER</b> 8031414889624 FANEU00007823 lumen			
	980 lm		
watt	8W		
beam angle	60°		



	colour temp.	colour	
<b>LED-W-POLO-R2-BCO</b> 8031414889631 FANEU00007824 lumen			
	1960 lm		
<b>LED-W-POLO-R2-NER</b> 8031414889648 FANEU00007825 lumen			
	1960 lm		
watt	2 x 8W		
beam angle	↓ 60° + 60° ↑		

# RAY



outdoor  
use



accommodation  
areas use



urban  
areas use





**LED-Wandleuchte aus Aluminium mit doppeltem sowie frontalem Lichtstrahl in Anthrazit oder geprägtem Corten. Bietet hervorragenden Sehkomfort und höchsten Schutz vor mechanischen Einwirkungen.**

LED wall lamp in aluminium with dual emission and front emission in anthracite or embossed corten. It provides excellent visual comfort and maximum protection against mechanical impacts.

**Material**  
Aluminium

**Farbe**  
Geprägt, Anthrazit  
Geprägt, Corten



**Wählbare Farbtemperatur**  
3000K / 4000K



**Driver**  
inklusive

**Material**  
aluminium

**Colour**  
embossed anthracite  
embossed corten



**Selectable color temperature**  
3000K / 4000K



**Driver**  
included



**LED-W-RAY ANT**

8031414867127  
FANEU00007826  
lumen

colour temp. | colour



1100+390 lm

watt 14W  
beam angle ↓ 50° + 50° ↑ + 120° →

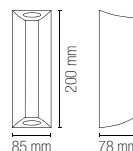

**LED-W-RAY BRO**

8031414870998  
FANEU00007827  
lumen

colour temp. | colour



1100+390 lm

watt 14W  
beam angle ↓ 50° + 50° ↑ + 120° →

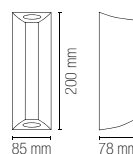

# TWIN

**LED-Wandleuchte aus Aluminium mit Finish in Weiß, Anthrazit oder gebürstetem Nickel. Mit Schalter für die Einstellung des Lichtfarbtons und darauf ausgelegt, eine hervorragende Beleuchtungssteuerung zu garantieren.**

LED wall lamp in aluminium with white, anthracite or brushed nickel finish. Featuring a switch for adjusting the light colour temperature, it is designed to ensure superior lighting control.

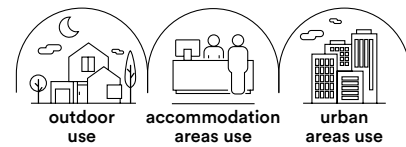

TWIN



In.tec light WANDLAMPEN / WALL LAMPS

# TWIN

**Material**

Aluminium

**Farbe**

Weiß  
Anthrazit  
Nickel, gebürstet



**Wählbare**

**Farbtemperatur**  
3000K / 4000K



**Driver**

inklusive

**Material**

aluminum

**Colour**

white  
anthracite  
brush nikel



**Selectable color temperature**

3000K / 4000K



**Driver**

included

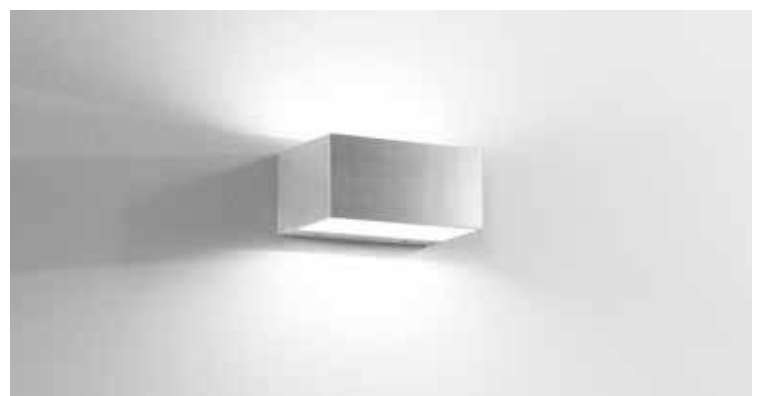

	colour temp.	colour
<b>LED-W-TWIN-S BCO</b> 8031414863976 FANEU00007854 lumen		
<b>LED-W-TWIN-S ANT</b> 8031414863709 FANEU00007853 lumen		
<b>LED-W-TWIN-S NIK</b> 8031414863983 FANEU00007855 lumen		

watt 12W  
beam angle ↓ 90° + 90° ↑

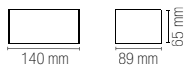

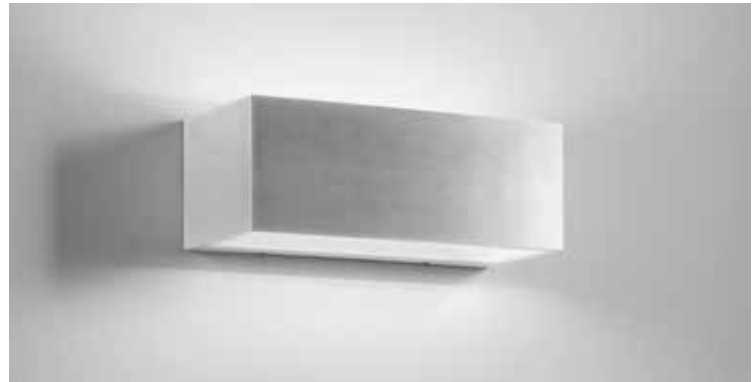

In.tec light **WANDLAMPEN / WALL LAMPS**

	colour temp.	colour
<b>LED-W-TWIN-M BCO</b> 8031414863969 FANEU00007849 lumen		
	2150 lm	
<b>LED-W-TWIN-M ANT</b> 8031414863693 FANEU00007848 lumen		
	2150 lm	
<b>LED-W-TWIN-M NIK</b> 8031414863990 FANEU00007850 lumen		
	2150 lm	

watt 18W  
beam angle ↓ 90° + 90° ↑

	colour temp.	colour
<b>LED-W-TWIN-XL BCO</b> 8031414863716 FANEU00007859 lumen		
	4260 lm	
<b>LED-W-TWIN-XL ANT</b> 8031414863686 FANEU00007858 lumen		
	4260 lm	
<b>LED-W-TWIN-XL NIK</b> 8031414864362 FANEU00007860 lumen		
	4260 lm	

watt 35W  
beam angle ↓ 90° + 90° ↑

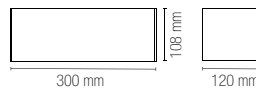
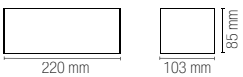

# COUPE





Die LED-Wandleuchte aus Aluminium Coupe bietet neben einer hervorragenden Farbtreue optimalen Schutz vor Staub und Flüssigkeiten. In drei Varianten - Weiß, Anthrazit und Bronze -, um sich harmonisch in den Stil der Außenbereiche einzufügen.

Coupe, a LED wall lamp in aluminium, features optimum protection against dust and liquids, as well as excellent colour fidelity. Available in three colour options – white, anthracite and bronze – to blend in harmoniously with the style of outdoor spaces.

**Material**

Aluminium

**Farbe**

Geprägt, Weiß  
Geprägt, Anthrazit  
Geprägt, Corten



**Farbtemperatur**

3000K



**Driver**

inklusive

**Material**

aluminium

**Colour**

embossed white  
embossed anthracite  
embossed corten



**Colour temperature**

3000K



**Driver**

included



**LED-W-COUPE-BCO**

8031414931644  
FANEU00027321  
lumen

colour temp.	colour

1950 lm

watt	14W
beam angle	120°

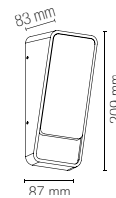

**LED-W-COUPE-ANT**

8031414931651  
FANEU00027320  
lumen

colour temp.	colour

1950 lm

watt	14W
beam angle	120°

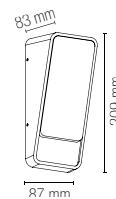

**LED-W-COUPE-BRO**

8031414931668  
FANEU00027322  
lumen

colour temp.	colour

1950 lm

watt	14W
beam angle	120°

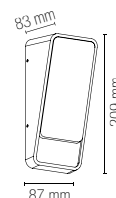

# DESERT



outdoor  
use



accommodation  
areas use



urban  
areas use





**LED-Wandleuchte aus Aluminium mit doppeltem seitlichen Lichtstrahl und frontalem CCT-Lichtstrahl. Erhältlich in den eleganten Finishes Weiß, Anthrazit und Bronze, um sich elegant in Wohn-, Gewerbe- oder Stadtumgebungen einzufügen.**

LED wall lamp in aluminium with dual emission at the side and CCT emission at the front. Available in an elegant white, anthracite and bronze finish to blend elegantly into residential, retail or urban areas.

**Material**  
Aluminium

**Farbe**  
Geprägt, Weiß  
Geprägt, Anthrazit  
Geprägt, Corten



**Farbtemperatur**  
3000K / 4000K



**Driver**  
inklusive

**Material**  
aluminium

**Colour**  
embossed white  
embossed anthracite  
embossed corten



**Colour temperature**  
3000K / 4000K



**Driver**  
included

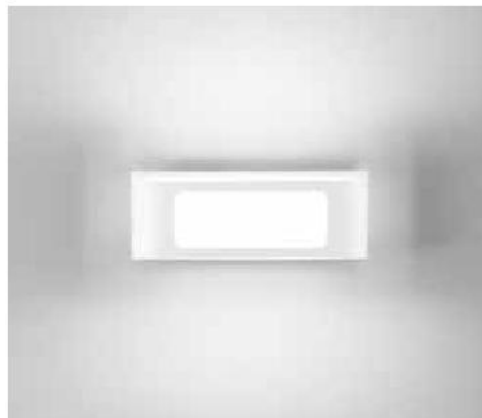

**LED-W-DESERT-BCO**

8031414922895  
FANEU00027361  
lumen

colour temp.	colour

1500 lm

watt	12W
beam angle	120°

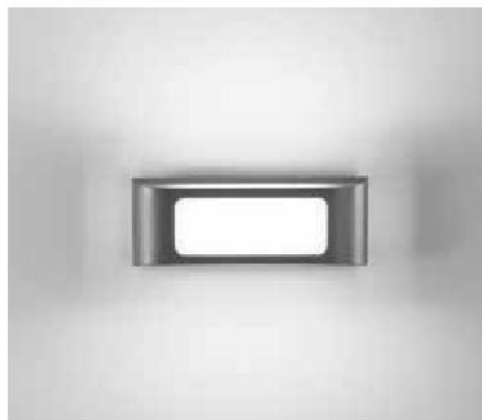

**LED-W-DESERT-ANT**

8031414922918  
FANEU00027360  
lumen

colour temp.	colour

1500 lm

watt	12W
beam angle	120°



**LED-W-DESERT-BRO**

8031414922901  
FANEU00027362  
lumen

colour temp.	colour

1500 lm

watt	12W
beam angle	120°



# DUKROT



**Wandleuchte aus Aluminium mit Diffusor aus Polycarbonat. Erhältlich in dem erlesenen Finish Corten, Anthrazit oder Mattweiß und mit individuell anpassbarer Farbtemperatur, um in Außen- wie Innenräumen die perfekte Beleuchtung und Atmosphäre zu schaffen.**

Wall lamp in aluminium with polycarbonate diffuser. Available in a refined corten, anthracite or matt white finish, with a customisable colour temperature to create the perfect lighting and atmosphere in outdoor or indoor spaces.

- Material**  
Aluminium

---

- Farbe**  
Mattweiß  
Anthrazit  
Corten
- 

---

- Wählbare Farbtemperatur**  
3000K / 4000K
- 

---

- Driver**  
eingebaut

---

- Material**  
aluminium

---

- Colour**  
matt white  
anthracite  
corten
- 

---

- Selectable color temperature**  
3000K / 4000K
- 

---

- Driver**  
built-in



<b>LED-W-DUKROT-BCO</b> 8031414918591 FANEU00007759 lumen	colour temp.	colour
1440 lm		
watt	12W	
beam angle	180°	

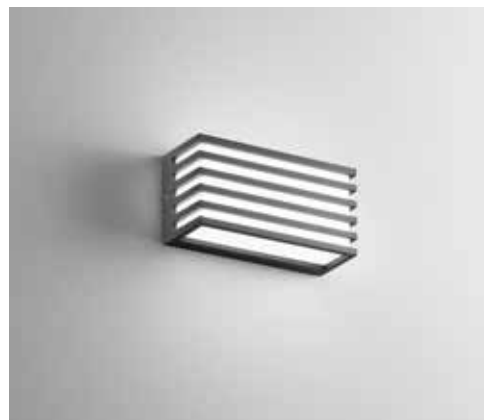

<b>LED-W-DUKROT-ANT</b> 8031414918584 FANEU00007758 lumen	colour temp.	colour
1440 lm		
watt	12W	
beam angle	180°	



<b>LED-W-DUKROT-BRO</b> 8031414918607 FANEU00007760 lumen	colour temp.	colour
1440 lm		
watt	12W	
beam angle	180°	

# WEISS

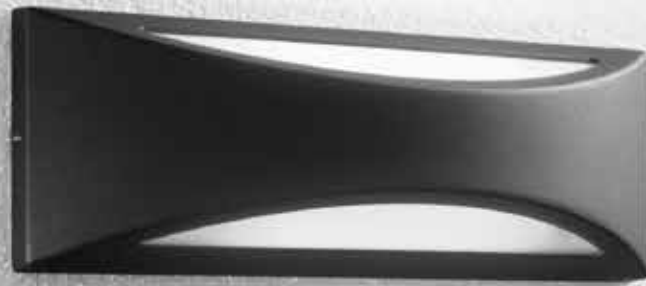

**LED-Wandleuchte aus Aluminium im Finish Weiß, Schwarz oder Corten. Doppelter Lichtstrahl, zwei Temperaturen und hervorragende Farbwiedergabe. Ideal für elegante Durchgangsbereiche und moderne städtische Räume.**

LED wall lamp in aluminium with white, black or corten finish. Dual emission, dual colour temperatures and excellent colour rendering. Ideal for elegant pass-through areas or modern urban spaces.

- Material**  
Aluminium

---

- Farbe**  
Weiß  
Schwarz  
Corten
- 

---

- Wählbare Farbtemperatur**  
3000K / 4000K
- 

---

- Driver**  
eingebaut

---

- Material**  
aluminium

---

- Colour**  
white  
black  
corten
- 

---

- Selectable color temperature**  
3000K / 4000K
- 

---

- Driver**  
built-in



<p><b>LED-W-WEISS-BCO</b> 8031414897193 FANEU00007866 lumen</p>	<table border="0"> <tr> <td>colour temp.</td> <td></td> <td></td> <td>colour</td> <td></td> </tr> <tr> <td colspan="2"></td> <td colspan="3">1800 lm</td> </tr> </table>	colour temp.			colour				1800 lm		
colour temp.			colour								
		1800 lm									
<table border="0"> <tr> <td>watt</td> <td style="text-align: right;">16W</td> </tr> <tr> <td>beam angle</td> <td style="text-align: right;">↓ 120° + 120° ↑</td> </tr> </table>		watt	16W	beam angle	↓ 120° + 120° ↑						
watt	16W										
beam angle	↓ 120° + 120° ↑										



<p><b>LED-W-WEISS-NER</b> 8031414897216 FANEU00007869 lumen</p>	<table border="0"> <tr> <td>colour temp.</td> <td></td> <td></td> <td>colour</td> <td></td> </tr> <tr> <td colspan="2"></td> <td colspan="3">1800 lm</td> </tr> </table>	colour temp.			colour				1800 lm		
colour temp.			colour								
		1800 lm									
<table border="0"> <tr> <td>watt</td> <td style="text-align: right;">16W</td> </tr> <tr> <td>beam angle</td> <td style="text-align: right;">↓ 120° + 120° ↑</td> </tr> </table>		watt	16W	beam angle	↓ 120° + 120° ↑						
watt	16W										
beam angle	↓ 120° + 120° ↑										



<p><b>LED-W-WEISS-BRO</b> 8031414897209 FANEU00007867 lumen</p>	<table border="0"> <tr> <td>colour temp.</td> <td></td> <td></td> <td>colour</td> <td></td> </tr> <tr> <td colspan="2"></td> <td colspan="3">1800 lm</td> </tr> </table>	colour temp.			colour				1800 lm		
colour temp.			colour								
		1800 lm									
<table border="0"> <tr> <td>watt</td> <td style="text-align: right;">16W</td> </tr> <tr> <td>beam angle</td> <td style="text-align: right;">↓ 120° + 120° ↑</td> </tr> </table>		watt	16W	beam angle	↓ 120° + 120° ↑						
watt	16W										
beam angle	↓ 120° + 120° ↑										

# BLOCK



---

**Material**

PC

---

**Farbe**

Weiß, Schwarz,  
Corten



---

**Wählbare  
Farbtemperatur**

3000K / 4200K / 6500K



---

**Driver**

eingebaut

---

**Material**

PC

---

**Colour**

white, black,  
corten



---

**Selectable color  
temperature**

3000K / 4200K / 6500K



---

**Driver**

built-in





**LED-Wandleuchte aus PC mit unverwechselbarem Design, erhältlich mit runder, quadratischer oder rechteckiger Form und in den drei Farbvarianten Weiß, Schwarz oder Corten. Ein Hauch von Persönlichkeit und individueller Gestaltung für Outdoor-Bereiche, der durch die wählbaren Lichtfarbtöne betont wird.**

LED wall lamp in polycarbonate, available in a round, square or rectangular shape, in three colour options: white, black or corten. A touch of personality and customisation for outdoor spaces, enhanced by selectable light colour temperatures.



	colour temp.	colour
<b>LED-W-BLOCK-R-BCO</b> 8031414947263 FANEU00028375 lumen	3000K 4000K 6000K	white
1900 lm		
<b>LED-W-BLOCK-R-NER</b> 8031414947256 FANEU00028374 lumen	3000K 4000K 6000K	black
1900 lm		
<b>LED-W-BLOCK-R-BRO</b> 8031414947249 FANEU00028373 lumen	3000K 4000K 6000K	corten
1900 lm		
watt	15W	
beam angle	100°	

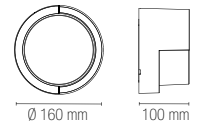

	colour temp.	colour
<b>LED-W-BLOCK-Q-BCO</b> 8031414927982 FANEU00007718 lumen	3000K 4000K 6000K	white
1800 lm		
<b>LED-W-BLOCK-Q-NER</b> 8031414927999 FANEU00007719 lumen	3000K 4000K 6000K	black
1800 lm		
<b>LED-W-BLOCK-Q-BRO</b> 8031414947225 FANEU00028371 lumen	3000K 4000K 6000K	corten
1800 lm		
watt	15W	
beam angle	100°	

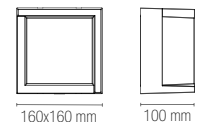

	colour temp.	colour
<b>LED-W-BLOCK-RT-BCO</b> 8031414927968 FANEU00007720 lumen	3000K 4000K 6000K	white
3210 lm		
<b>LED-W-BLOCK-RT-NER</b> 8031414927975 FANEU00007721 lumen	3000K 4000K 6000K	black
3210 lm		
<b>LED-W-BLOCK-RT-BRO</b> 8031414947232 FANEU00028372 lumen	3000K 4000K 6000K	corten
3210 lm		
watt	24W	
beam angle	100°	

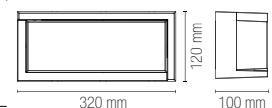

# BORDER



**Abgewinkelte LED-Wandleuchte mit Struktur und Diffusor aus Polycarbonat im Finish Weiß oder Anthrazit. Für Außenbereiche ausgelegt, bietet Schutz vor Staub und Flüssigkeiten, höchste Schlagfestigkeit und hervorragenden Sehkomfort.**

Corner LED wall lamp with a polycarbonate fixture and diffuser in a matt white or anthracite finish. Designed for outdoor use, it provides protection against dust and liquids, with maximum resistance to impacts and excellent visual comfort.

**Material**  
PC

**Farbe**  
Mattweiß  
Mattanthrazit



**Farbtemperatur**  
3000K / 4000K



**Driver**  
inklusive

**Material**  
PC

**Colour**  
matt white  
matt anthracite



**Colour temperature**  
3000K / 4000K



**Driver**  
included



**LED-BORDER-30M-BCO**

8031414883578  
FANEU00005889  
lumen

colour temp. | colour



3550 lm

watt 30W  
beam angle 120°

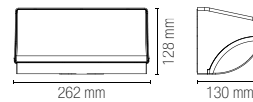

**LED-BORDER-30M-ANT**

8031414883561  
FANEU00005888  
lumen

colour temp. | colour



3550 lm

watt 30W  
beam angle 120°

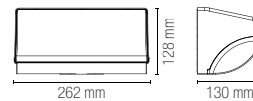



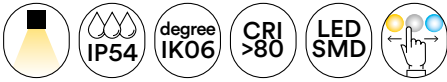

**LED-Wandleuchte aus Polycarbonat, erhältlich in zwei Farbvarianten: weiß oder schwarz. Der Leuchtkörper bietet hohe Farbwiedergabe und drei Farbtemperaturen, um den Außenbereichen Charakter zu verleihen.**

LED wall lamp in polycarbonate, available in two colour options: black or white. The light fixture provides high colour rendering and three colour temperatures to enhance outdoor spaces.

- Material**  
Aluminium und Acryl

---

- Farbe**  
Weiß  
Schwarz

---

- Wählbare Farbtemperatur**  
3000K / 4200K / 6500K

---

- Driver**  
eingebaut

---

- Material**  
aluminum and acrylic

---

- Colour**  
white  
black

---

- Selectable color temperature**  
3000K / 4200K / 6500K

---

- Driver**  
built-in



	colour temp.	colour
<b>LED-W-RIM-BCO</b> 8031414927920 FANEU00007832		
lumen	2500 lm	

watt	20W
beam angle	100°

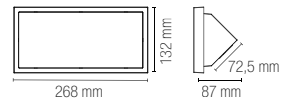

	colour temp.	colour
<b>LED-W-RIM-NER</b> 8031414927937 FANEU00007833		
lumen	2500 lm	

watt	20W
beam angle	100°

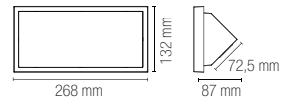

# LUXON



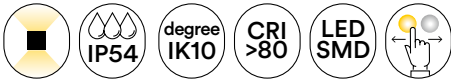

**Abgewinkelte LED-Wandleuchte mit Struktur aus Aluminium in geprägtem Finish: weiß oder schwarz. Mit doppeltem Lichtstrahl, zwei Farbtemperaturen, extremer Stoßfestigkeit und Kontrolle der Blendung.**

Corner LED wall lamp with an aluminium fixture and embossed finish available in: black or white. It features dual emission, dual colour temperatures, exceptional resistance to impacts and glare control.

**Material**  
Aluminium

**Farbe**  
Geprägt, Weiß  
Geprägt, Schwarz



**Wählbare Farbtemperatur**  
3000K / 4000K



**Driver**  
inklusive

**Material**  
aluminium

**Colour**  
embossed white  
embossed black



**Selectable color temperature**  
3000K / 4000K



**Driver**  
included



	colour temp.	colour
<b>LED-W-LUXON BCO</b> 8031414870677 FANEU00007795	 	
lumen	1550 lm	

watt	12W
beam angle	120°

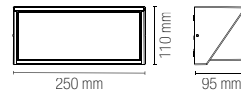

	colour temp.	colour
<b>LED-W-LUXON ANT</b> 8031414867097 FANEU00007794	  	
lumen	1550 lm	

watt	12W
beam angle	120°

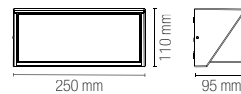

# GRIS





**Wandleuchte aus Aluminium mit energiesparender SMD-LED-Lichtquelle und zwei Lichtfarbtönen. Das spezielle Design macht sie für Außen- wie Innenbereiche von Gewerbe-, Wohn- oder Stadtumgebungen gleichermaßen geeignet.**  
 Aluminium wall lamp fitted with an energy-saving LED SMD light source and two light colour temperatures. Its unique design makes it ideal for both outdoor and indoor spaces in retail, residential or urban areas.

**Material**  
Aluminium

**Farbe**  
Weiß  
Schwarz



**Wählbare Farbtemperatur**  
3000K / 4000K



**Driver**  
eingebaut

**Material**  
aluminium

**Colour**  
white  
black



**Selectable color temperature**  
3000K / 4000K



**Driver**  
built-in



**LED-W-GRIS-BCO**

8031414897223  
FANEU00007775  
lumen

colour temp.	colour
--------------	--------



1390 lm

watt	12W
beam angle	180°

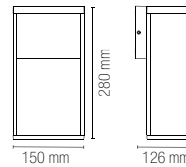

**LED-W-GRIS-NER**

8031414897230  
FANEU00007777  
lumen

colour temp.	colour
--------------	--------



1390 lm

watt	12W
beam angle	180°

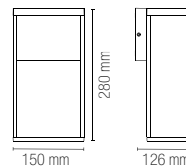

# AGERA





**LED-Wandleuchte aus schwarzem geprägtem Aluminium in zwei Größen. Mit zweistufiger Beleuchtung, doppeltem Lichtstrahl und hoher Farbtreue, für einen essenziellen, doch nicht banalen Lichtpunkt.**

LED wall lamp in black embossed aluminium, available in two dimensions. It features two colour temperatures, dual emission and high colour fidelity for a minimalist yet striking light source.

**Material**

Aluminium

**Farbe**

Geprägt, Schwarz



**Wählbare Farbtemperatur**

3000K / 4000K



**Driver**

inklusive

**Material**

aluminum

**Colour**

embossed black



**Selectable color temperature**

3000K / 4000K



**Driver**

included



**LED-W-AGERA-90**

8031440360951

FANEU00007657

lumen

colour temp.



colour

680 lm

watt

2 x 3W

beam angle

↓ 120° + 120° ↑

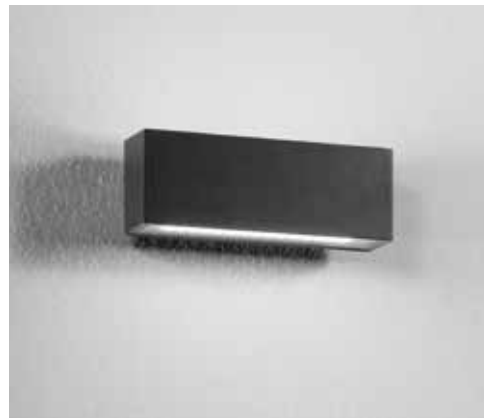
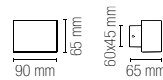

**LED-W-AGERA-180**

8031440360975

FANEU00007656

lumen

colour temp.



colour

1380 lm

watt

2 x 6W

beam angle

↓ 120° + 120° ↑

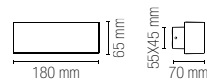

# BOXTER

Wandleuchte aus geprägtem Aluminium mit verschiedenen Finishs: Weiß, Silber, Schwarz oder Corten. Die Lichtquelle mit doppeltem Lichtstrahl und zwei Farbtönen basiert auf einer hocheffizienten COB-LED.

Wall lamp in embossed aluminium, available in various finishes: white, silver, black or corten. The dual-emission light source with two colour temperatures is powered by high-efficiency COB LEDs.



outdoor  
use

accommodation  
areas use

urban  
areas use



**Material**  
Aluminium

**Farbe**  
Weiß  
Silber  
Schwarz  
Corten



**Wählbare Farbtemperatur**  
3000K / 4000K



**Driver**  
inklusive

**Material**  
aluminium

**Colour**  
white  
silver  
black  
corten



**Selectable color temperature**  
3000K / 4000K



**Driver**  
included



**LED-W-BOXTER BCO**

8031414873043  
FANEU00007722  
lumen

colour temp.	colour

960 lm

watt 2 × 4W  
beam angle ↓ 120° + 120° ↑

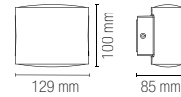

**LED-W-BOXTER SIL**

8031414862399  
FANEU00007725  
lumen

colour temp.	colour

960 lm

watt 2 × 4W  
beam angle ↓ 120° + 120° ↑

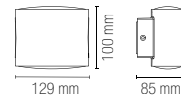

**LED-W-BOXTER NER**

8031414862382  
FANEU00007724  
lumen

colour temp.	colour

960 lm

watt 2 × 4W  
beam angle ↓ 120° + 120° ↑

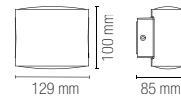

**LED-W-BOXTER BRO**

8031414862405  
FANEU00007723  
lumen

colour temp.	colour

960 lm

watt 2 × 4W  
beam angle ↓ 120° + 120° ↑

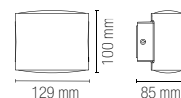





**CCT-LED-Wandleuchte aus Polycarbonat mit einfachem oder mehrfachem doppeltem Lichtstrahl. Korrosionsfest, garantiert Schlagfestigkeit und Schutz vor Staub und Flüssigkeiten, was sie für Außenbereiche und Swimmingpools geeignet macht.**

CCT LED wall lamps in polycarbonate with dual emission, single or multiple. An anti-corrosive product guaranteeing impact resistance and protection against dust and liquids, making it ideal for outdoor spaces and swimming pools.

**Material**  
PC

**Farbe**  
Mattweiß  
Mattschwarz



**Farbtemperatur**  
3000K / 4000K



**Driver**  
eingebaut

**Material**  
PC

**Colour**  
matt white  
matt black



**Colour temperature**  
3000K / 4000K



**Driver**  
built-in

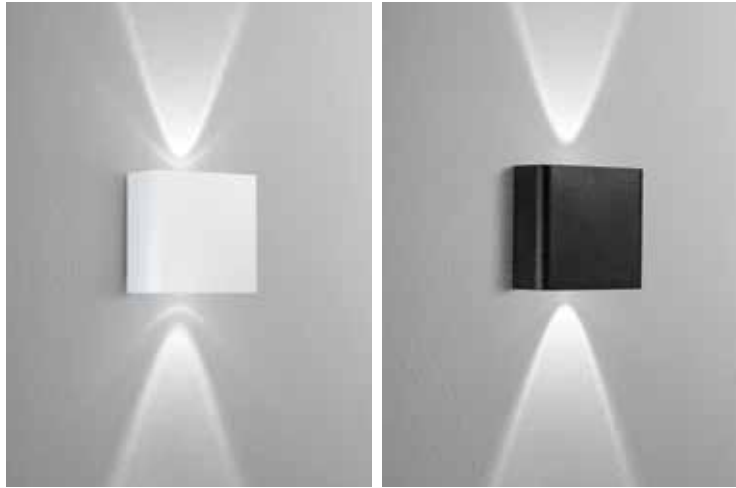

	colour temp.	colour
<b>LED-W-KLEIN-AP2-BCO</b> 8031414916337 FANEU00007782 lumen		
	240 lm	
<b>LED-W-KLEIN-AP2-NER</b> 8031414916320 FANEU00007783 lumen		
	240 lm	
watt	2W	
beam angle	60°	

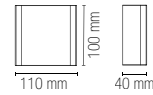

	colour temp.	colour
<b>LED-W-KLEIN-AP6-BCO</b> 8031414916351 FANEU00007784 lumen		
	800 lm	
<b>LED-W-KLEIN-AP6-NER</b> 8031414916344 FANEU00007785 lumen		
	800 lm	
watt	6W	
beam angle	60°	

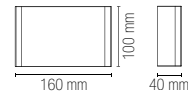

# BEETLE



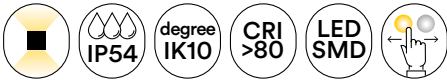

**LED-Wandleuchte aus geprägtem weißem oder anthrazitfarbenem Aluminium, gekennzeichnet durch den von mehreren Lichtpunkten erzeugten doppelten Lichtstrahl. Ein weiches und ausgesuchtes Design, bestehend aus extrem widerstandsfähigen Materialien.**

LED wall lamp in white or anthracite embossed aluminium, featuring dual emission powered by multiple light points. A sleek and sophisticated design made of ultra-resistant materials.

- Material**  
Aluminium

---

- Farbe**  
Geprägt, Weiß  
Geprägt, Anthrazit
- 

---

- Wählbare Farbtemperatur**  
3000K / 4000K
- 

---

- Driver**  
inklusive

---

- Material**  
aluminium

---

- Colour**  
embossed white  
embossed anthracite
- 

---

- Selectable color temperature**  
3000K / 4000K
- 

---

- Driver**  
included

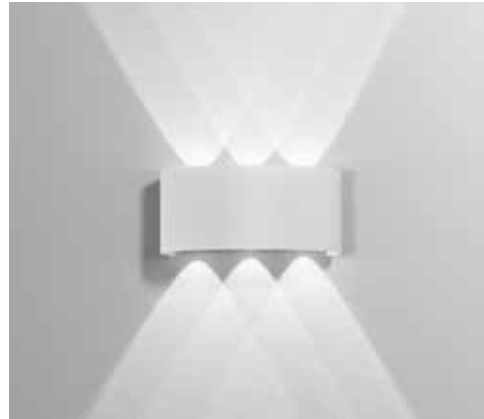

<b>LED-W-BEETLE BCO</b> 8031414876952 FANEU00007709 lumen	colour temp.	colour
watt	6W	
beam angle	100°	

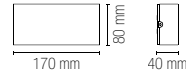

<b>LED-W-BEETLE GR</b> 8031414876969 FANEU00007710 lumen	colour temp.	colour
watt	6W	
beam angle	100°	

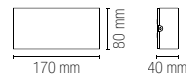

# HERCULES

Technisch-dekorative LED-Wandleuchte mit Aluminiumgehäuse und Corten-Finish sowie Diffusor aus Polycarbonat. Widerstandsfähige Ausführung und gesteigerter Charme dank der auswählbaren Farbtemperatur.

Technical-decorative LED wall lamp with aluminium fixture in corten finish, and polycarbonate diffuser. Made to last, its selectable colour temperature enhances its appeal.



---

**Material**

Aluminium und Acryl

---

**Farbe**

Corten



---

**Wählbare Farbtemperatur**

2700K / 3300K / 4000K



---

**Driver**

inklusive

---

**Material**

aluminum and acrylic

---

**Colour**

corten



---

**Selectable color temperature**

2700K / 3300K / 4000K



---



**Driver**



included



---





	colour temp.	colour
<b>LED-HERCULES-100</b>	  	
8031414935093		
FANEU00027271		
lumen	3500 lm	

	colour temp.	colour
<b>LED-HERCULES-140</b>	  	
8031414935109		
FANEU00027272		
lumen	6800 lm	

	colour temp.	colour
<b>LED-HERCULES-200</b>	  	
8031414935116		
FANEU00027273		
lumen	6800 lm	

watt	23W
beam angle	120°
pf	0.95

watt	47W
beam angle	120°
pf	0.98

watt	47W
beam angle	120°
pf	0.98

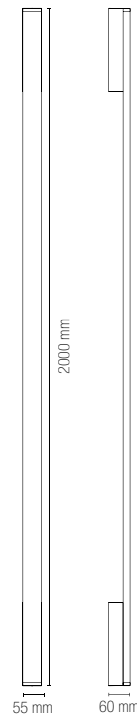
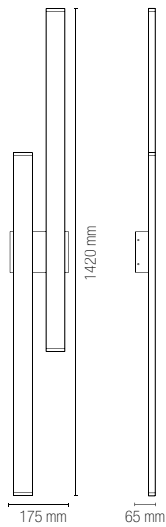
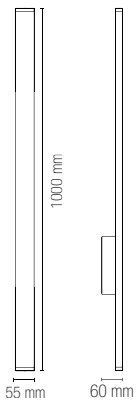

# RIBBON





**LED-Streifen aus geprägtem Aluminium mit anthrazitfarbenem Finish. Entwickelt, um Eleganz und gleichzeitig Schutz vor Staub und Flüssigkeiten, Schlagfestigkeit und hohe Farbwiedergabe zu garantieren.**  
 LED strip light in embossed aluminium with an anthracite finish. Designed to ensure elegance and protection against dust and liquids, with impact resistance and high colour rendering.

- Material**  
Aluminium

---

- Farbe**  
Geprägt, Anthrazit
- 

---

- Farbtemperatur**  
4000K
- 

---

- Driver**  
inklusive

---

- Material**  
aluminium

---

- Colour**  
embossed anthracite
- 



---

- Colour temperature**  
4000K
- 



---

- Driver**  
included

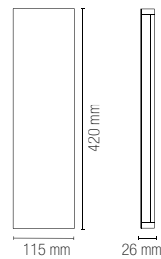

	colour temp.	colour
<b>LED-RIBBON-42</b>		
8031414882335		
FANEU00007268		
lumen	1600 lm	
watt	2 x 6W	
beam angle	120°	



	colour temp.	colour
<b>LED-RIBBON-72</b>		
8031414882342		
FANEU00007269		
lumen	2600 lm	
watt	2 x 10W	
beam angle	120°	

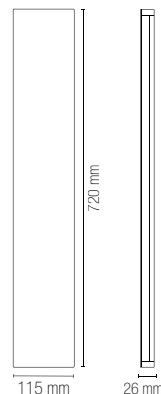

# LASER



outdoor  
use



accommodation  
areas use



urban  
areas use



**Thermoplastisches LED-Band. Fügt sich perfekt in Gewerbe-, Wohn- oder Stadtbereiche ein, indem er diesen mit seinem extrem minimalistischen Design und der Beleuchtung mit einzelner oder doppelter sauberer Lichtstrahl Charakter verleiht.**

LED strip light in thermoplastic. It seamlessly integrates into retail, residential or urban spaces, giving them that extra edge with its ultra-minimalist design and single or double clear beam of light.

- Material**  
Thermoplast

---

- Farbe**  
Schwarz
- 

---

- Farbtemperatur**  
4000K
- 

---

- Driver**  
inklusive

---

- Material**  
thermoplastic

---

- Colour**  
black
- 





---

- Colour temperature**  
4000K
- 





---

- Driver**  
included



<b>LED-LASER</b>	colour temp.	colour
8031414882328		
FANEU00006685		
lumen	170 lm	
watt	3W	
beam angle	5°	
 40 mm	 75 mm	 30 mm



<b>LED-LASER-BIS</b>	colour temp.	colour
8031414882311		
FANEU00006686		
lumen	40 lm	
watt	5W	
beam angle	2 x 4°	
 36 mm	 100 mm	 20 mm



# ALFA

**LED-Wandleuchte aus Aluminium mit auswählbarem Lichtfarbton (CCT) und unabhängig verstellbaren Lamellen, die es gestatten, den Lichtstrahl individuell auszurichten. Erhältlich in 4 geprägten Finishes: Weiß, Silber, Anthrazit und Corten.**

LED wall lamp in aluminium with selectable light colour temperatures (CCT) and independent adjustable baffles for customising the beam of light. Available in 4 embossed finishes: white, silver, anthracite and corten.

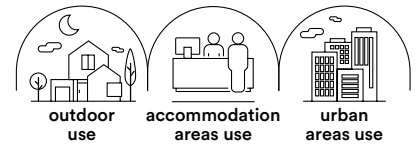

ALFA



In.tec light WANDLAMPEN / WALL LAMPS

# ALFA

## Material

Aluminium

## Farbe

Geprägt, Weiß  
Geprägt, Silber  
Geprägt, Anthrazit  
Geprägt, Corten



## Farbtemperatur

3000K / 4000K



## Driver

inklusive

## Material

aluminum

## Colour

embossed white  
embossed silver  
embossed anthracite  
embossed corten



## Colour temperature

3000K / 4000K



## Driver

included



### LED-W-ALFA-10-BCO

8031414905843

FANEU00007665

lumen

colour temp. | colour



1200 lm

watt

10W

beam angle ↓ 10°/120° + 10°/120° ↑

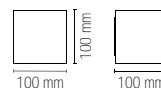

### LED-W-ALFA-10-GR

8031414905850

FANEU00007669

lumen

colour temp. | colour



1200 lm

watt

10W

beam angle ↓ 10°/120° + 10°/120° ↑

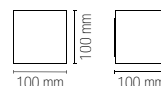

### LED-W-ALFA-10-ANT

8031414929351

FANEU00009571

lumen

colour temp. | colour



1200 lm

watt

10W

beam angle ↓ 10°/120° + 10°/120° ↑

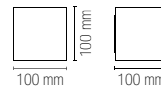

### LED-W-ALFA-10-BRO

8031414929368

FANEU00009572

lumen

colour temp. | colour



1200 lm

watt

10W

beam angle ↓ 10°/120° + 10°/120° ↑

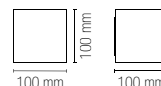

Licht mit doppeltem Lichtstrahl und unabhängig verstellbaren Lamellen /  
Bi-emission light with independent adjustable wings

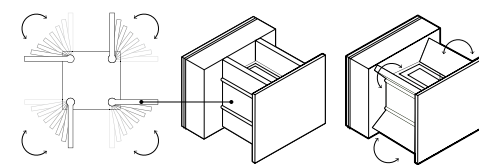
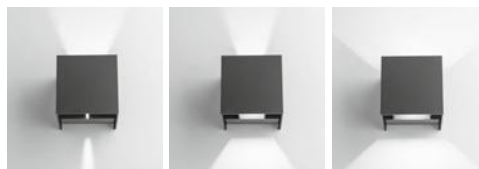

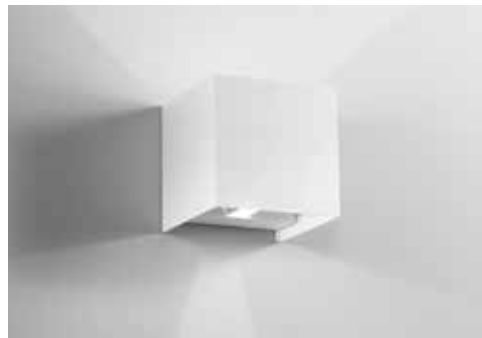

**LED-W-ALFA-20-BCO**

8031414905867  
FANEU00007679  
lumen

colour temp. | colour



1800 lm

watt 18W  
beam angle  $\downarrow 10^\circ/120^\circ + 10^\circ/120^\circ \uparrow$

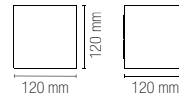

**LED-W-ALFA-20-GR**

8031414929344  
FANEU00009569  
lumen

colour temp. | colour



1800 lm

watt 18W  
beam angle  $\downarrow 10^\circ/120^\circ + 10^\circ/120^\circ \uparrow$

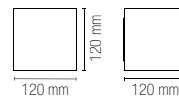

**LED-W-ALFA-20-ANT**

8031414905874  
FANEU00007678  
lumen

colour temp. | colour



1800 lm

watt 18W  
beam angle  $\downarrow 10^\circ/120^\circ + 10^\circ/120^\circ \uparrow$

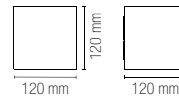

**LED-W-ALFA-20-BRO**

8031414905881  
FANEU00007680  
lumen

colour temp. | colour



1800 lm

watt 18W  
beam angle  $\downarrow 10^\circ/120^\circ + 10^\circ/120^\circ \uparrow$

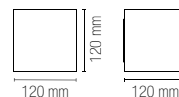

# DELTA



**LED-Wandleuchte aus geprägtem weißem oder silbernem Aluminium mit unabhängig verstellbaren Lamellen zum Ausrichten der beiden Lichtstrahlen. Die Beleuchtung erfolgt mit dynamischer Temperatur (CCT).**

LED wall lamp in white or silver embossed aluminium with independent adjustable baffles to direct the two beams of light. Dynamic temperature control (CCT) lighting.

**Material**  
Aluminium

**Farbe**  
Geprägt, Weiß  
Geprägt, Silber



**Farbtemperatur**  
3000K / 4000K



**Driver**  
inklusive

**Material**  
aluminum

**Colour**  
embossed white  
embossed silver



**Colour temperature**  
3000K / 4000K



**Driver**  
included



**LED-W-DELTA-10-BCO**

8031414905829  
FANEU00007732  
lumen

colour temp. | colour



1200 lm

watt 2 x 5W  
beam angle ↓ 10°/120° + 10°/120° ↑

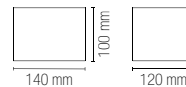

**LED-W-DELTA-10-GR**

8031414905836  
FANEU00007735  
lumen

colour temp. | colour



1200 lm

watt 2 x 5W  
beam angle ↓ 10°/120° + 10°/120° ↑

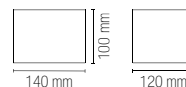

Licht mit doppeltem Lichtstrahl und unabhängig verstellbaren Lamellen /  
Bi-emission light with independent adjustable wings

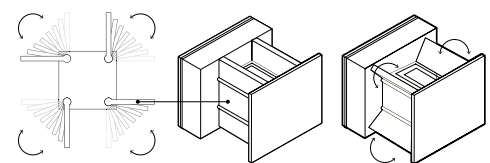
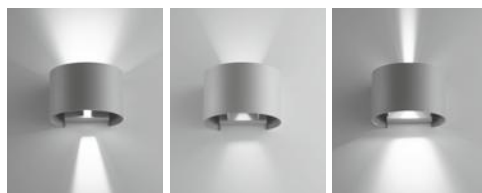

# PARKER

**LED-Wandleuchte aus weißem oder grauem natürlichem Zement. Erhältlich in verschiedenen Größen, verleiht Outdoor-Bereichen einen minimalistischen und plastischen Look und bietet eine sehr hohe Farbwiedergabe und Schutz vor Flüssigkeiten und Staub.**

LED wall lamp in white or natural grey cement. Available in various sizes, it adds a minimalist, textured touch to outdoor spaces, providing protection and excellent colour rendering, as well as protection against liquids and dust.

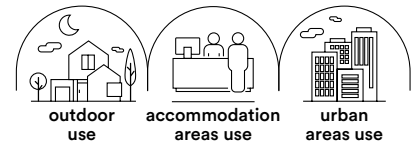

PARKER



In.tec light WANDLAMPEN / WALL LAMPS

# PARKER

**Material**  
Zement

**Farbe**  
Weiß  
Grau



**Wählbare  
Farbtemperatur**  
3000K / 4000K



**Driver**  
inklusive

**Material**  
concrete

**Colour**  
white  
grey



**Selectable color  
temperature**  
3000K / 4000K



**Driver**  
included



Verbinder IP65  
enthalten /  
IP65 connector  
included



## LED-PARKER-AP30 GR

8031414866977

FANEU00007029

lumen

colour  
temp.



1080 lm

watt

9W

beam angle

↓ 120° + 120° ↑

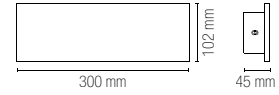

## LED-PARKER-AP50 GR

8031414866984

FANEU00007035

lumen

colour  
temp.



2100 lm

watt

16W

beam angle

↓ 120° + 120° ↑

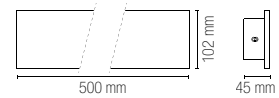





 Verbinder IP65  
 enthalten /  
 IP65 connector  
 included



**LED-PARKER-AP30**

8031414864195  
 FANEU00007028  
 lumen

colour temp.	colour
	
	

1080 lm

watt 9W  
 beam angle ↓ 120° + 120° ↑



**LED-PARKER-AP40**

8031414864201  
 FANEU00007032  
 lumen

colour temp.	colour
	
	

1400 lm

watt 12W  
 beam angle ↓ 120° + 120° ↑

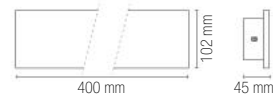

**LED-PARKER-AP60**

8031414862504  
 FANEU00007038  
 lumen

colour temp.	colour
	
	

2640 lm

watt 20W  
 beam angle ↓ 120° + 120° ↑

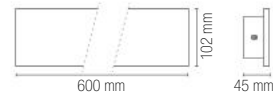

**LED-PARKER-AP120**

8031414862511  
 FANEU00007025  
 lumen

colour temp.	colour
	
	

3800 lm

watt 30W  
 beam angle ↓ 120° + 120° ↑



# PORTLAND

Zylindrische Wandleuchte aus weißem Zement mit GU10-Sockel, doppeltem Lichtstrahl und hohem Schutz vor Staub und Flüssigkeiten. So diskret wie unverwechselbar, wertet Durchgangsbereiche sowie städtische Umgebungen auf schlichte Weise auf.

Cylindrical wall lamp in white cement with GU10 fitting, dual emission and high protection against dust and liquids. Understated yet refined, it enhances transit areas and urban spaces with its simplicity.



colour

**I-PORTLAND-AP2 BCO**  
8031414863563  
FANEU00003208

2 x GU10 MAX 35W

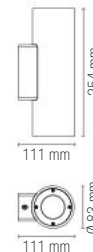

Verbinder IP65 enthalten /  
IP65 connector included



Glühbirne nicht enthalten /  
Light bulb not included

# OAKLAND



LED-Wandleuchte aus weißem Zement mit doppeltem Lichtstrahl.  
 Der GU10-Sockel bietet Funktionalität und Robustheit für eine perfekte Verschmelzung mit modernen Außenbereichen, insbesondere Gewerbe- und Wohngebieten.

LED wall lamp in white cement with dual emission. The GU10 fitting provides functionality and durability seamlessly blending with modern outdoor environments, especially retail or residential spaces.



colour

**I-OAKLAND-AP2 BCO**  
 8031414864218  
 FANEU00002965

2 x GU10 MAX 10W

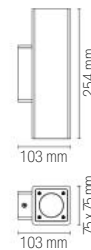

Verbinder IP65 enthalten /  
 IP65 connector included



Glühbirne nicht enthalten /  
 Light bulb not included

# JUMP

Zylindrische LED-Wandleuchte aus Aluminium mit doppeltem Lichtstrahl. In drei Finishes erhältlich - Weiß, Silber oder aus Edelstahl -, um sich harmonisch an die Linien und die **Konstruktionsmaterialien der Außenbereiche anzupassen.**

Cylindrical LED wall lamp in aluminium with dual emission. Available in three finishes – white, silver or stainless steel - to harmonise with the lines and materials used in outdoor areas.





Glühbirne nicht  
enthalten /  
Light bulb  
not included



colour

**I-JUMP-AP2 BCO**

8031414862351

FANEU00002383



**I-JUMP-AP2 SIL**

8031414862344

FANEU00002385



**I-JUMP-AP2 INOX**

8031414862368

FANEU00002384



2 x GU10 MAX 35W

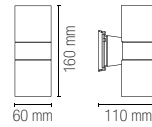

Glühbirne nicht  
enthalten /  
Light bulb  
not included



colour

**I-JUMP-AP2-E27 SIL**

8031414865390

FANEU00002386



2XE27 MAX 60W

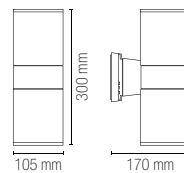





**Aus Glas und Aluminium hergestellter Artikel, erhältlich in den Farben Weiß oder Anthrazit mit symmetrischem Lichtstrahl. Das spezielle Design verleiht einen Hauch von Persönlichkeit und ist ideal für neutrale Außenbereiche.**

A product made of glass and aluminium, available in white or anthracite with a symmetrical beam of light. Its unique design adds a touch of personality that is ideal for neutral outdoor spaces.



Empfohlene Glühbirne / Suggested light bulb



Glühbirne nicht enthalten / Light bulb not included



colour

**I-ROSEN-AP-BCO**

8031414931316  
FANEU00025169



1 x E27 MAX 25W

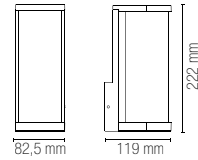

colour

**I-ROSEN-AP-ANT**

8031414931330  
FANEU00025170



1 x E27 MAX 25W

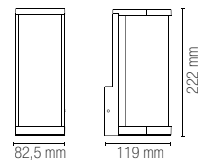

# ONE

LED-Wandleuchte aus geprägtem Aluminium in Weiß, Anthrazit oder Corten. Mit einzeitigem oder doppeltem Lichtstrahl und in zwei Größen erhältlich. Der GU10-Sockel gestattet eine diskrete Verschmelzung mit der Outdoor-Umgebung.

LED wall lamp in white, anthracite or corten embossed aluminium. Available with single or dual emission and in two sizes. The GU10 fitting enables it to subtly blend in with outdoor environments.





Glühlampe nicht  
enthalten /  
Light bulb  
not included



	colour
<b>I-ONE-AP1 BCO</b> 8031414878857 FANEU00002982	
<b>I-ONE-AP1 ANT</b> 8031414073009 FANEU00002981	
<b>I-ONE-AP1 BRO</b> 8031414048861 FANEU00002983	

1 x GU10 MAX 35W



Glühlampe nicht  
enthalten /  
Light bulb  
not included



	colour
<b>I-ONE-AP2 BCO</b> 8031414878864 FANEU00002985	
<b>I-ONE-AP2 ANT</b> 8031414082100 FANEU00002984	
<b>I-ONE-AP2 BRO</b> 8031414079995 FANEU00002986	

2 x GU10 MAX 35W

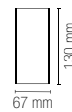

# QUBO

LED-Wandleuchte mit GU10-Sockel aus geprägtem Aluminium in Weiß, Anthrazit oder Corten. Erhältlich in der quadratischen Mini-Version mit einzeltem Lichtstrahl oder der normalen Ausführung mit doppeltem Lichtstrahl.

LED wall lamp with GU10 fitting in white, anthracite or corten embossed aluminium. Available in a mini square version with single emission or in the standard version with dual emission.





Glühlampe nicht  
enthalten /  
Light bulb  
not included



	colour
<b>I-QUBO-AP1 BCO</b> 8031414878833 FANEU00003443	
<b>I-QUBO-AP1 ANT</b> 8031414084203 FANEU00003442	
<b>I-QUBO-AP1 BRO</b> 8031414082117 FANEU00003444	

1 x GU10 MAX 35W



Glühlampe nicht  
enthalten /  
Light bulb  
not included



	colour
<b>I-QUBO-AP2 BCO</b> 8031414878840 FANEU00003446	
<b>I-QUBO-AP2 ANT</b> 8031414084289 FANEU00003445	
<b>I-QUBO-AP2 BRO</b> 8031414083336 FANEU00003447	

2 x GU10 MAX 35W

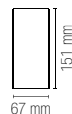

# POPUP

Wandleuchte aus Metall, erhältlich in zwei verschiedenen Größen und in drei Farbvarianten: Weiß, Bronze oder Schwarz. Mit praktischem GU10-Sockel zum diskreten und vereinfachten Einfügen in die Outdoor-Bereiche.

Metal wall lamp, available in two different sizes and in three colour options: white, bronze or black. With a practical GU10 fitting for subtle and easy integration into outdoor spaces.





Glühbirne nicht  
enthalten /  
Light bulb  
not included



	colour
<b>I-POPUP-M-BCO</b> 8031414935123 FANEU00026202	
<b>I-POPUP-M-NER</b> 8031414935130 FANEU00026203	
<b>I-POPUP-M-BRO</b> 8031414935147 FANEU00026204	

1 x GU10 MAX 15W

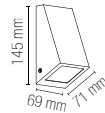

Glühbirne nicht  
enthalten /  
Light bulb  
not included



	colour
<b>I-POPUP-L-BCO</b> 8031414935154 FANEU00026205	
<b>I-POPUP-L-NER</b> 8031414935161 FANEU00026206	
<b>I-POPUP-L-BRO</b> 8031414935178 FANEU00026207	

1 x E27 MAX 15W

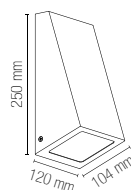

# TUCSON



outdoor  
use



accommodation  
areas use



urban  
areas use



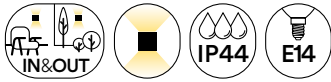

**Wandleuchte mit Diffusor aus Polycarbonat und Gehäuse aus Aluminium in den Finishs Weiß, Silber oder Bronze. Das elegante Design und die Beleuchtung mit doppeltem Lichtstrahl machen die Wandleuchte ideal für gehobene Innen- sowie Außenumgebungen in zeitgemäßem Stil.**

Wall lamp with diffuser in polycarbonate and aluminium fixture in a white, silver or bronze finish. Its elegant design and dual emission lighting make this wall lamp ideal for contemporary, stylish environments, both indoors and outdoors.



Empfohlene Glühbirne / Suggested light bulb



Glühbirne nicht enthalten / Light bulb not included



colour

**I-TUCSON-AP BCO**  
8031414862160  
FANEU00003866

---

2 x E14 MAX 40W

---



colour

**I-TUCSON-AP SIL**  
8031414862184  
FANEU00003868

---

2 x E14 MAX 40W

---



colour

**I-TUCSON-AP BRO**  
8031414862191  
FANEU00003867

---

2 x E14 MAX 40W

---

# SOLIX





**Wandleuchte mit Gehäuse und Vorderseite aus Aluminium und Diffusor aus PC. Erhältlich in den Farben Weiß, Nickel oder Schwarz, bietet Beleuchtung mit dreifachem Lichtstrahl und Schutz vor Stößen, Staub und Wasser.**

Wall lamp with aluminum front and PC diffuser.  
Available in white, nickel or black, it provides triple-emission lighting and protection against impacts, dust and water.



Glühbirne nicht enthalten /  
Light bulb not included



**I-SOLIX-AP-BCO**  
8031414946839  
FANEU00028324

colour



1 x E27 MAX 20W

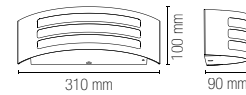

**I-SOLIX-AP-CR**  
8031414946792  
FANEU00028320

colour



1 x E27 MAX 20W

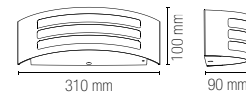

**I-SOLIX-AP-NER**  
8031414946846  
FANEU00028325

colour



1 x E27 MAX 20W

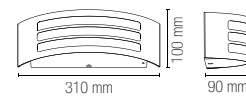

# AUSTIN

Wandleuchte aus Aluminium in den Finishs Weiß, Silber, Schwarz oder Bronze. Der Diffusor mit dreifachem Lichtstrahl ist aus Polycarbonat hergestellt. Eine diskrete und funktionelle Lösung mit Schutz vor Flüssigkeiten und Staub.

Wall lamp in aluminium, available in a white, silver, black or bronze finish. The diffuser, made of polycarbonate, features triple emission. An understated, functional solution with protection against liquids and dust.

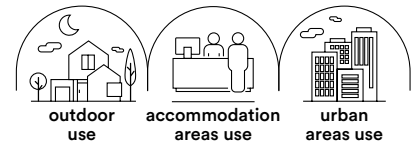



Glühbirne nicht enthalten /  
Light bulb not included



colour

**I-AUSTIN-AP BCO**  
8031440362122  
FANEU00001201



1 x E27 MAX 42W

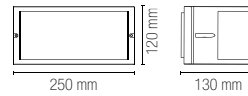

colour

**I-AUSTIN-AP SIL**  
8031414862429  
FANEU00001204



1 x E27 MAX 42W

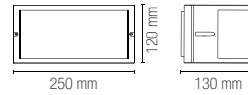

colour

**I-AUSTIN-AP NER**  
8031440362139  
FANEU00001203



1 x E27 MAX 42W

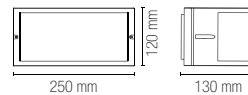

colour

**I-AUSTIN-AP BRO**  
8031440362108  
FANEU00001202



1 x E27 MAX 42W

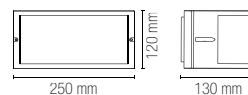

# ATLANTA

Wandleuchte aus Aluminium mit elegantem anthrazitfarbenem Finish und mattem Diffusor aus Polycarbonat. Mit Schutz vor Staub und Flüssigkeiten zur sicheren Verwendung in Outdoor-Umgebungen.

Wall lamp in aluminium with an elegant anthracite finish and opal diffuser in polycarbonate. It features protection against dust and liquids for safe use in outdoor environments.



I-ATLANTA-AP  
8031440312257  
FANEU00001183

colour



1 x E27 MAX 42W

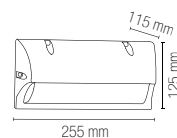

Glühbirne nicht enthalten /  
Light bulb not included

# DENVER

Wandleuchte mit doppeltem Lichtstrahl aus Aluminium. Mit mattem Diffusor aus Polycarbonat mit anthrazitfarbenem Finish, für eine gleichermaßen funktionelle und dekorative Beleuchtung.

Wall lamp with dual emission, made of aluminium. With an opal diffuser in polycarbonate and an anthracite finish for lighting that is both functional and decorative.

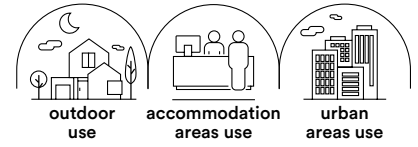

**I-DENVER-AP**  
8031440312264  
FANEU00001580

colour



1 x E27 MAX 42W

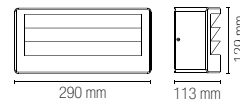

Glühbirne nicht enthalten /  
Light bulb not included

# MONDRIAN

Wandleuchte aus Metall in Weiß, Schwarz, Silber oder Bronze mit Diffusor aus Glas. Ein klassisches Design mit zeitgemäßem Touch, um sich harmonisch in verschiedene Architekturstile einzufügen.

Wall lamp in white, black, silver or bronze metal with glass diffuser.

A classic design with a nod to contemporary style, harmoniously blending in with various architectural styles.



**I-MONDRIAN-AP BCO**  
8031414896134  
FANEU00002848

colour



**I-MONDRIAN-AP SIL**  
8031414862306  
FANEU00002851



**I-MONDRIAN-AP NER**  
8031414896127  
FANEU00002850



**I-MONDRIAN-AP BRO**  
8031414862313  
FANEU00002849



1 x E27 MAX 25W

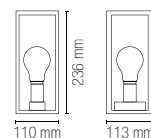

Glühbirne nicht  
enthalten /  
Light bulb not  
included

# GAETA

Laterne aus Aluminiumdruckguss mit schwarz-goldenem Finish und Diffusor aus Glas. Gaeta ist eine Einrichtungsergänzung für Außenbereiche mit starker Persönlichkeit und macht in klassischen wie schicken Umgebungen gleichermaßen eine tadellose Figur.

Lantern in die-cast aluminium with black and gold finish, and glass diffuser. Gaeta is an outdoor furnishing item with a striking personality, impeccable in both classic and trendy settings.



**LANT-GAETA-AP1**  
8031440313278  
FANEU00005561

colour



1 x E27 MAX 60W

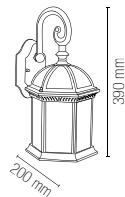

Glühbirne nicht  
enthalten /  
Light bulb not  
included

# PAVÈ

**LED-Strahler aus anthrazitfarbenem Metall und transparentem Glas. Bietet Schlagfestigkeit und hohen Schutz vor Flüssigkeiten und Staub. Erhältlich in drei Größen, kann durch Zubehör zur Befestigung mit Pflock ergänzt werden.**

LED spotlight in anthracite metal and transparent glass. It provides impact resistance and high protection against liquids and dust. Available in three sizes, it can be complemented with the peg fixing accessory.



**Material**  
Metall,  
Diffusor  
transparentes Glas

**Farbe**  
Anthrazit



**Farbtemperatur**  
3000K



**Driver**  
eingebaut

**Material**  
metal  
transparent glass  
diffuser

**Colour**  
anthracite



**Colour temperature**  
3000K



**Driver**  
built-in



**LED-PAVE-7**  
8031414922925  
FANEU00027278  
lumen

colour temp.	colour
730 lm	

watt	6W
beam angle	45°
pf	-

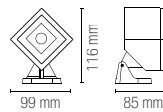

**Nicht enthaltenes Zubehör/  
Accessory not included**

Zubehör für  
Befestigung mit Pflock /  
Accessory for  
peg fixing



**LED-PAVE-7-SPK**  
8031414937226  
FANEU00027105



**LED-PAVE-20**  
8031414922932  
FANEU00027277  
lumen

colour temp.	colour
2300 lm	

watt	17W
beam angle	45°
pf	-

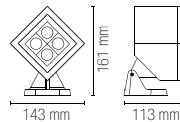

**LED-PAVE-2030-SPK**  
8031414937233  
FANEU00027106



**LED-PAVE-30**  
8031414922949  
FANEU00027276  
lumen

colour temp.	colour
3500 lm	

watt	26W
beam angle	45°
pf	0.90

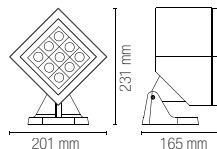

**LED-PAVE-2030-SPK**  
8031414937233  
FANEU00027106

# WAX



outdoor  
use



accommodation  
areas use



urban  
areas use





**Kollektion aus Aluminium mit integrierter LED und anthrazitfarbenem geprägtem Finish. Mit Befestigungspflock, bietet warmes Licht und drei verschiedene Höhen. Ideal, um Gärten im Außenbereich und Räumlichkeiten im zeitgemäßen Stil Charakter zu verleihen.**

Collection in aluminium with integrated LED, with anthracite embossed finish. With a peg for fixing, it provides a warm light and is available in three different heights. Ideal for enhancing outdoor gardens and spaces in contemporary style.

**Material**  
Aluminium

**Farbe**  
Geprägt, Anthrazit



**Farbtemperatur**  
3000K



**Driver**  
DC 24V  
Konstantspannung  
nicht enthalten

**Material**  
aluminium

**Colour**  
embossed anthracite



**Colour temperature**  
3000K



**Driver**  
DC 24V  
constant voltage  
not included



Driver ab S. /from p. 414  
Controller ab S. /from p. 430

**LED-WAX-P120**  
8031414922956  
FANEU00027444  
lumen

colour temp.	colour
385lm	

watt	3W
beam angle	120°

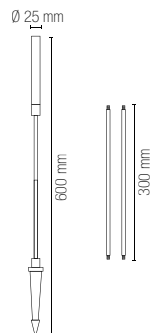

Pflock für Installation im Boden enthalten / Spike for installation in the ground included

# PUCK



outdoor  
use



accommodation  
areas use



urban  
areas use





**Eine minimalistische Kollektion aus Aluminium mit LED und Finish in Anthrazit oder geprägtem Corten. So elegant wie unkonventionell, bietet Puck optimale Schlagfestigkeit, Schutz vor Staub und Flüssigkeiten und hohe Farbtreue.**

A minimalist collection in aluminium with LED lighting, in anthracite or corten embossed finish. Both elegant and unconventional, Puck provides excellent impact resistance, protection against dust and liquids, and high colour fidelity.

**Material**  
Aluminium

**Farbe**  
Geprägt, Anthrazit  
Geprägt, Corten



**Farbtemperatur**  
3000K



**Driver**  
DC 24V  
Konstantspannung nicht  
enthalten

**Material**  
aluminium

**Colour**  
embossed anthracite  
embossed corten



**Colour temperature**  
3000K



**Driver**  
DC 24V  
constant voltage  
not included

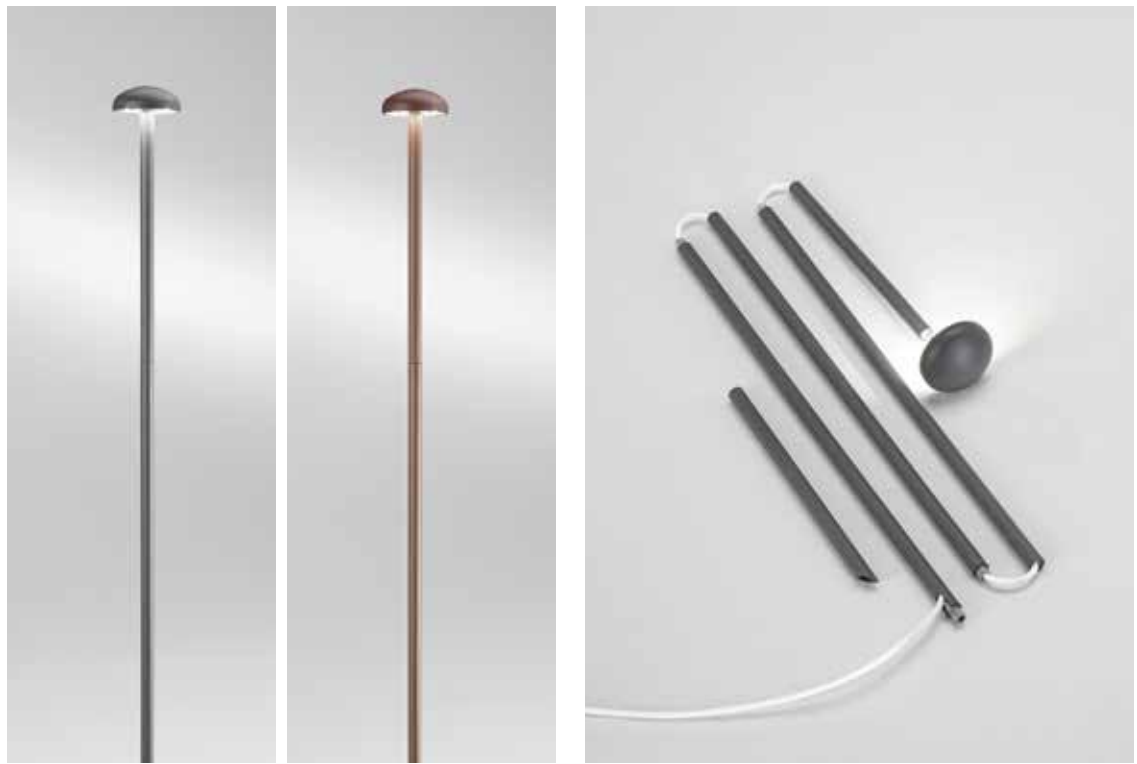

**LED-PUCK-P120-ANT**

8031414918652  
FANEU00007154  
lumen

colour temp.	colour
360 lm	

**LED-PUCK-P120-BRO**

8031414918669  
FANEU00007155  
lumen

360 lm	

watt	3W
beam angle	180°

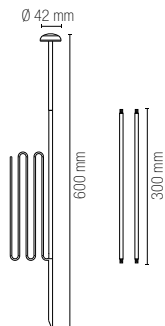

# PEG

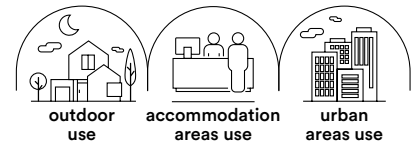

**Flutlichtleuchte aus Thermoplast mit warmer oder kalter Farbtemperatur. Inklusive Pflock, bietet optimale Farbwiedergabe und einen hervorragenden Schutz vor Wasser und Staub.**

Floodlight in thermoplastic with a warm or cool colour temperature. With a peg included, it provides optimum colour rendering and excellent protection against water and dust.

**Material**  
PC

**Farbe**  
Schwarz

**Farbtemperatur**  
3000K / 4000K



**Driver**  
eingebaut

**Material**  
PC

**Colour**  
black

**Colour temperature**  
3000K / 4000K



**Driver**  
built-in



**LED-PEG-9C-NER**

8031414889600  
FANEU00007090  
lumen

colour temp. | colour

900 lm

**LED-PEG-9M-NER**

8031414895403  
FANEU00007091  
lumen

900 lm

watt 9W  
beam angle 60°

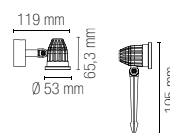

# HAYDON

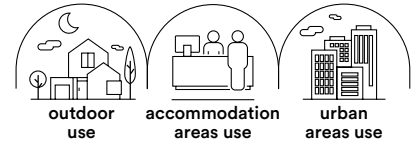

**Flutlichtstrahler aus Aluminium inklusive Pflock. Liefert eine Beleuchtung mit COB-LED und überlegenen technischen Eigenschaften: hervorragender Schutz vor Stößen, Staub und Flüssigkeiten und überragende Farbtreue.**  
 Floodlight in aluminium, peg included. It provides lighting with integrated COB LED and superior technical features: optimum protection against impacts, dust and liquids, and excellent colour fidelity.

**Material**  
Aluminium

**Farbe**  
Schwarz



**Farbtemperatur**  
3000K / 4000K / 6000K



**Driver**  
inklusive

**Material**  
aluminium

**Colour**  
black



**Colour temperature**  
3000K / 4000K / 6000K



**Driver**  
included



**LED-HAYDON-15**  
8031414938995  
FANEU00027561  
lumen

colour temp.  
  
1490 lm

watt 15W  
beam angle 30°



**LED-HAYDON-30**  
8031414933754  
FANEU00025859  
lumen

colour temp.  
  
3155 lm

watt 30W  
beam angle 30°

Photometrie des Produkts / Photometric curve

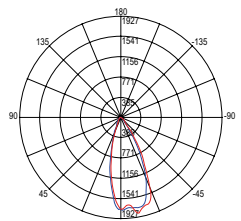

LED-HAYDON-15

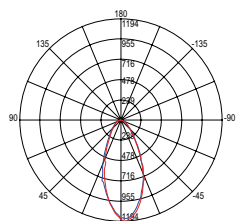

LED-HAYDON-30

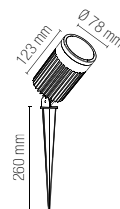
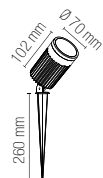

# GRUBB

Flutlichtleuchte aus schwarzem Thermoplast. Ausgestattet mit Erdspieß und inklusive SMD-LED-Leuchtmittel, für eine diskrete Installation in Grünflächen von Stadt-, Wohn- oder Gewerbegebieten dank des Schutzes gegen Flüssigkeiten und Staub.

Floodlight in black thermoplastic. Equipped with ground spike and SMD LED bulb included, as well as a functional GU10 fitting, for discreet installation in green spaces in urban, residential or commercial areas, thanks to its protection against liquids and dust.



**LED-GRUBB-7M**  
8031414883554  
FANEU00006312

1 x E27

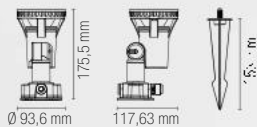

colour



Enthaltenes Zubehör /  
Accessories included



**LED-SMD-Glühbirne /  
LED SMD light bulbs**

watt	7W
beam angle	100°
cri	80
on/off	>10.000
life time	25000h

4000K	
lumen	510 lm
dimmer	



**LED-GRUBB-15M**  
8031414883547  
FANEU00006311

1 x E27

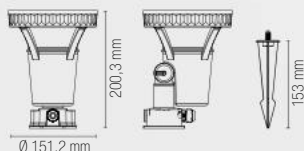

colour



Enthaltenes Zubehör /  
Accessories included



**LED-SMD-Glühbirne /  
LED SMD light bulbs**

watt	15W
beam angle	100°
cri	80
on/off	>10.000
life time	25000h

4000K	
lumen	1100 lm
dimmer	

# AKRON

Kollektion von Aluminium-Flutlichtleuchten mit weißem, schwarzem oder Corten-Finish inklusive Pflock. Liefert einen optimalen Schutz vor Wasser und Staub und gestattet dank des GU10-Sockels die direkte Verkabelung.

Collection of floodlights in aluminium with white, black or corten finish, peg included. It provides optimum protection against water and dust, with direct wiring, thanks to the GU10 fitting.



colour

**I-AKRON-BCO**  
8031414882649  
FANEU00001018



**I-AKRON-NER**  
8031414882663  
FANEU00001021



**I-AKRON-BRO**  
8031414882656  
FANEU00001019



1 x GU10 MAX 35W



Glühbirne nicht enthalten  
/ Light bulb not included

WANDLAMPEN / WALL LAMPS  
In.tec light

# DROP

**Kollektion aus Aluminium mit anthrazitfarbenem Finish und Diffusor aus Polycarbonat. Bietet eine diffuse und hocheffiziente Beleuchtung (mit G9-Sockel) sowie hervorragende Beständigkeit gegen Staub und Flüssigkeiten. So einfach wie charakteristisch.**

Collection in aluminium with anthracite finish and polycarbonate diffuser. It provides high-efficiency diffused lighting (with a G9 fitting) and excellent resistance to dust and liquids. Simple yet striking.





Empfohlene Glühbirne / Suggested light bulb



Glühbirne nicht enthalten / Light bulb not included



**I-DROP-P33-ANT**  
8031414883073  
FANEU00001710

colour



1 x G9 LED

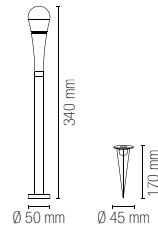

**I-DROP-P53-ANT**  
8031414883080  
FANEU00001711

colour



1 x G9 LED

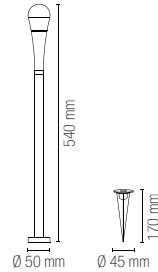

**I-DROP-P73-ANT**  
8031414882793  
FANEU00001712

colour



1 x G9 LED

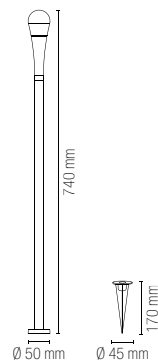





**Deckenleuchten / Ceiling lamps**  
outdoor

# CITIZEN





**Wandleuchte aus Aluminium in den Finishs Weiß, Schwarz und Corten. Erhältlich in der Version als Würfel oder Zylinder, verleiht sowohl Außen- als auch Innenumgebungen einen Hauch von minimalistischer Eleganz, was sie insbesondere für Beherbergungsbetriebe ideal macht.**

Ceiling lamp in aluminium with white, black or corten finish. Available in cubic or cylindrical version, it adds a touch of minimalist elegance to outdoor and indoor spaces, making it especially ideal for hospitality facilities.



	colour
<b>I-CITIZEN-Q1-BCO</b> 8031414882922 FANEU00001469	
<b>I-CITIZEN-Q1-NER</b> 8031414882939 FANEU00001471	
<b>I-CITIZEN-Q1-BRO</b> 8031414882915 FANEU00001470	

1 x E27

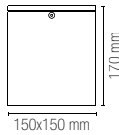

Empfohlene Glühbirne / Suggested light bulb



Glühbirne nicht enthalten / Light bulb not included



	colour
<b>I-CITIZEN-R1-BCO</b> 8031414882892 FANEU00001473	
<b>I-CITIZEN-R1-NER</b> 8031414882908 FANEU00001475	
<b>I-CITIZEN-R1-BRO</b> 8031414882885 FANEU00001474	

1 x E27

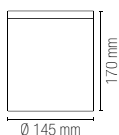

Empfohlene Glühbirne / Suggested light bulb



Glühbirne nicht enthalten / Light bulb not included

# TOWER





**Wandleuchte mit Gehäuse aus Aluminium, erhältlich im Finish Weiß, Schwarz oder Corten. Die Kollektion zeichnet sich durch minimalistische Formen und den leicht zurückgesetzten Diffusor aus, um Innen- und Außenräume von städtischen Einrichtungen und Bereichen individuell zu gestalten.**

Ceiling lamp with aluminium fixture, available in white, black or corten finish. The collection features minimalist shapes and a slightly recessed diffuser for customising indoor and outdoor spaces of buildings and urban areas.



	colour
<b>I-TOWER-Q1-BCO</b> 8031414922093 FANEU00003827	
<b>I-TOWER-Q1-NER</b> 8031414922116 FANEU00003829	
<b>I-TOWER-Q1-BRO</b> 8031414922109 FANEU00003828	

1 x GX53



Glühbirne nicht  
enthalten /  
Light bulb  
not included



	colour
<b>I-TOWER-R1-BCO</b> 8031414918522 FANEU00003830	
<b>I-TOWER-R1-NER</b> 8031414918515 FANEU00003832	
<b>I-TOWER-R1-BRO</b> 8031414918539 FANEU00003831	

1 x GX53



Glühbirne nicht  
enthalten /  
Light bulb  
not included

# TOGO

**Eine Kollektion von LED-Wandleuchten aus Acryl, erhältlich in verschiedenen Geometrien und Größen. Bietet drei Farbtemperaturen, hervorragenden Schutz vor Staub und Flüssigkeiten und hohe Farbwiedergabe. Eine Lösung für eine minimalistische, doch dabei hochwertige Beleuchtung.**

A collection of LED ceiling lamps in acrylic, available in various shapes and sizes. Featuring three colour temperatures, it provides excellent protection against dust and liquids, and high colour rendering. A solution for minimalist yet high-quality lighting.





**Material**  
Acryl PMMA

**Farbe**  
Weiß



**Wählbare Farbtemperatur**  
3000K / 4000K / 6500K



**Driver**  
eingebaut

**Material**  
PMMA acrylic

**Colour**  
white



**Selectable color temperature**  
3000K / 4000K / 6500K



**Driver**  
built-in driver



**LED-TOGO-Q10**  
8031414883615  
FANEU00007532  
lumen

colour temp.	colour

600 lm

watt	5W
beam angle	120°

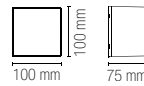

**LED-TOGO-Q25**  
8031414883646  
FANEU00007533  
lumen

colour temp.	colour

2400 lm

watt	20W
beam angle	120°

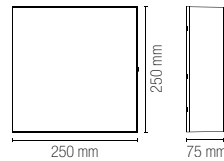

**LED-TOGO-RT20**  
8031414883622  
FANEU00007535  
lumen

colour temp.	colour

1000 lm

watt	8W
beam angle	120°

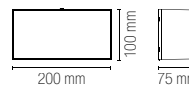

**LED-TOGO-RT30**  
8031414883639  
FANEU00007536  
lumen

colour temp.	colour

1500 lm

watt	12W
beam angle	120°



# ISCHIA



**Wandleuchte mit Gehäuse aus weißem Thermoplast und transparentem Diffusor mit diamantartiger Wirkung. Mit integrierter LED, CCT-Technologie und hoher Farbwiedergabe, bietet Schutz vor Staub, Flüssigkeiten und Stößen, für eine hervorragende Beständigkeit in Außen- und Innenumgebungen.**

Ceiling lamp with white thermoplastic fixture and diamond-effect transparent diffuser. With integrated LED, CCT technology and high colour rendering, it provides protection against dust, liquids and impacts, for optimum durability in outdoor and indoor spaces.



**Material**

Thermoplast

**Farbtemperatur**

3000K / 4000K



**Driver**

eingebaut

**Material**

thermoplastic

**Colour temperature**

3000K / 4000K



**Driver**

built-in



**LED-ISCHIA-L-BCO**

8031414883608  
FANEU00006510  
lumen

colour temp.



2400 lm

watt 20W  
beam angle 100°

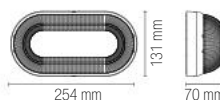

# CAPRI



Deckenleuchte mit transparentem Diffusor mit diamantartiger Wirkung auf weißem Gehäuse aus Thermoplast. Mit integrierter LED und einstellbarer Farbtemperatur und so sowohl für Innen- als auch für Außenumgebungen von städtischen Bereichen oder Räumlichkeiten von Beherbergungsbetrieben geeignet.  
 Ceiling light with white thermoplastic body and transparent diffuser with diamond effect. With integrated LED and adjustable colour temperature, it is ideal for indoor spaces, urban areas or hospitality spaces.



In.tec light DECKENLEUCHTEN / CEILING LAMPS

## Materiale

Thermoplast

## Farbtemperatur

3000K / 4000K



## Driver

eingebaut

## Material

thermoplastic

## Colour temperature

3000K / 4000K



## Driver

built-in



### LED-CAPRI-S-BCO

8031414883585  
 FANEU00005944  
 lumen

colour temp. | colour



2440 lm

watt 20W  
 beam angle 120°

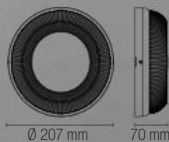

### LED-CAPRI-L-BCO

8031414883592  
 FANEU00005943  
 lumen

colour temp. | colour

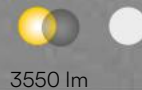

3550 lm

watt 28W  
 beam angle 120°

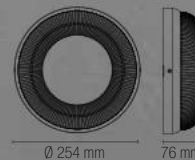

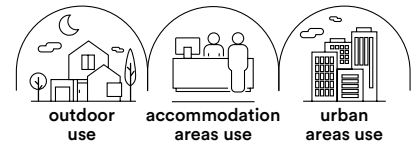

**Material**  
PC + PC

**Farbtemperatur**

2700K / 3000K / 4000K / 5000K / 6500K



**Driver**  
eingebaut

**Material**  
PC + PC

**Colour temperature**

2700K / 3000K / 4000K / 5000K / 6500K



**Driver**  
built-in



**Deckenleuchte aus Thermoplast mit internem Leistungs- und Farbtemperaturwähler. Der Artikel ist außerdem mit integriertem 5.8-GHz-Radarsensor mit Bewegungs- und Dämmerungsfunktion und Taste zur Einstellung der Dauer ausgestattet.**

Ceiling lamp in thermoplastic with integrated power and colour temperature selector. The product also features an integrated 5.8GHz radar sensor with motion and twilight functions and duration adjustment button.

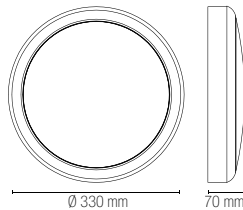

**LED-ALWAYS-RS**  
8031414926923  
FANEU00005764  
lumen

colour temp.	colour
max 3120	

watt	15W / 20W / 25W
beam angle	120°
pf	0.90



Sensormodus: OFF - nur Bewegung - Dämmerung + Bewegung /  
Sensor mode: OFF - motion only - dusk + motion

Auswahl der Einschaltdauer mit Bewegungssensor 30 s - 60 s - 180 s /  
Motion sensor duration selection: 30S - 60S - 180S

Auswahl Grad Kelvin: 2700 K 3000 K 4000 K 5000 K 6500 K /  
Kelvin degrees selection: 2700K 3000K 4000K 5000K 6500K

Leistungsauswahl: 15 W 20 W 25 W /  
Power selection: 15W 20W 25W

# HUBLLOT SENS



**Material**  
PC + PC

**Farbtemperatur**  
3000K / 4300K / 6500K



**Driver**  
eingebaut

**Material**  
PC + PC

**Colour temperature**  
3000K / 4300K / 6500K



**Driver**  
built-in



**Deckenleuchte aus Thermoplast mit internem Farbtemperaturwähler und integriertem und einstellbarem Mikrowellen-Bewegungssensor zur optimalen Steuerung der Beleuchtung und der Energieeinsparung.**  
Ceiling lamp in thermoplastic with integrated colour temperature selector and adjustable microwave motion sensor for optimum lighting control and energy saving.

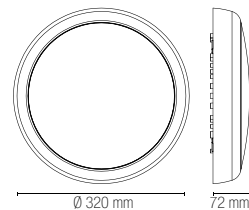

## LED-HUBLLOT-SENS

8031414919604  
FANEU00006442  
lumen

colour temp.	colour
2500 lm	

watt	18W
beam angle	120°
pf	0.90

### Enthaltenes Zubehör / Accessories included

Bewegungssensor 100 % Licht  
Nach 30 Sekunden 20 % Licht /  
Motion sensor 100% light  
After 30 seconds 20% light

Sensor regulierbar mit LED-SENSOR-REMOTE S. 440  
adjustable sensor with LED-SENSOR-REMOTE p. 440

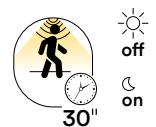

DECKENLEUCHTEN / CEILING LAMPS

In.tec light

# SENSITIVE





**Deckenleuchte mit integrierter LED, Bewegungs- und Farbtemperatursensor (Kelvin), beide einstellbar. Der weiße Diffusor aus Polycarbonat ist mit einem Gehäuse aus polypropylenbasiertem Material kombiniert und in den Finishes Weiß oder Anthrazit erhältlich.**

Ceiling lamp with integrated LED, with adjustable motion sensor and Kelvin setting. The white polycarbonate diffuser is matched with a base body in PP, available in white or anthracite finish.

**Material**

PP + PC

**Farbe**

Weiß  
Anthrazit



**Farbtemperatur**

3000K / 4000K



**Driver**

eingebaut

**Material**

PP + PC

**Colour**

white  
anthracite



**Colour temperature**

3000K / 4000K



**Driver**

built-in



**Enthaltenes Zubehör / Accessories included**

Regulierbarer Bewegungssensor / Adjustable motion sensor

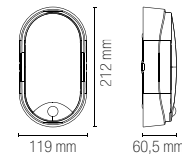
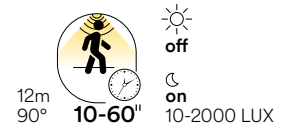

	colour temp.	colour
<b>LED-SENSITIVE-C BCO</b> 8031414876815 FANEU00007345 lumen	3000K	white
<b>LED-SENSITIVE-BCO</b> 8031440361750 FANEU00007344 lumen	4000K	white
<b>LED-SENSITIVE-ANT</b> 8031440361743 FANEU00007343 lumen	4000K	anthracite
watt	14W	
beam angle	120°	

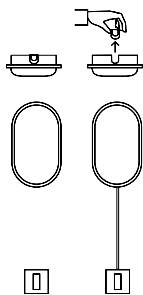

Doppeltes Installationssystem / Double installation system

# EXTRA



outdoor  
use



accommodation  
areas use



urban  
areas use





**Deckenleuchte mit integrierter LED, Basis aus weißem oder anthrazitfarbenem PP und weißem Diffusor aus Polycarbonat. Mit doppeltem Installationssystem und Auslegung für Anlagen mit externen Kabelkanälen.**

Ceiling lamp with integrated LED, white or anthracite PP base and white polycarbonate diffuser. With dual installation system and provision for systems with external conduits.

**Material**

PP + PC

**Farbe**

Weiß  
Anthrazit



**Farbtemperatur**

4000K



**Driver**

eingebaut

**Material**

PP + PC

**Colour**

white  
anthracite



**Colour temperature**

4000K



**Driver**

built-in

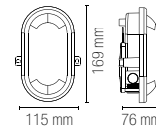

	colour temp.	colour
<b>LED-EXTRA-BCO</b>		
8031440361071		
FANEU00006220		
lumen	1100 lm	
<b>LED-EXTRA-ANT</b>		
8031440361064		
FANEU00006219		
lumen	1100 lm	
watt	10W	
beam angle	120°	

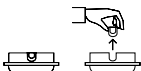

Doppeltes Installationssystem /  
Double installation system

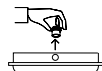

Geeignet für Installationen mit externen Kabelkanälen /  
Surface mount cable ducts connections

# SHELLY



**Deckenleuchte mit Diffusor und Basis aus Polycarbonat in den Farben Weiß und Anthrazit. Mit CCT-Funktion für doppelte Farbtemperatur, entweder warm oder neutral. Garantiert Beständigkeit gegen Witterungseinflüsse und Beleuchtungskomfort.**  
 Ceiling lamp with white or anthracite polycarbonate diffuser and base. It features a CCT function for dual colour temperature, warm or neutral. It guarantees weather resistance and lighting comfort.

**Material**  
PC + PC

**Farbe**  
Weiß  
Anthrazit



**Farbtemperatur**  
3000K / 4000K



**Driver**  
eingebaut

**Material**  
PC + PC

**Colour**  
white  
anthracite



**Colour temperature**  
3000K / 4000K



**Driver**  
built-in

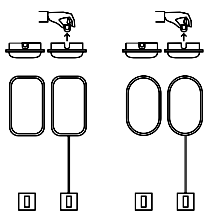

Doppeltes  
Installationssystem /  
Double  
installation system



**LED-SHELLY-Q-S BCO**

8031414085507  
FANEU00007386  
lumen

colour temp.	colour

1900 lm

**LED-SHELLY-Q-S ANT**

8031414862009  
FANEU00007385  
lumen

colour temp.	colour

1900 lm

watt	15W
beam angle	120°

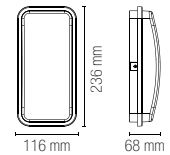

**LED-SHELLY-Q-L BCO**

8031414862016  
FANEU00007381  
lumen

colour temp.	colour

2510 lm

**LED-SHELLY-Q-L ANT**

8031414862023  
FANEU00007380  
lumen

colour temp.	colour

2510 lm

watt	20W
beam angle	120°

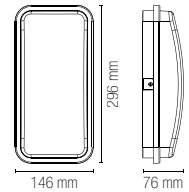

**LED-SHELLY-S BCO**

8031440351720  
FANEU00007389  
lumen

colour temp.	colour

1900 lm

**LED-SHELLY-S ANT**

8031440351706  
FANEU00007388  
lumen

colour temp.	colour

1900 lm

watt	15W
beam angle	120°

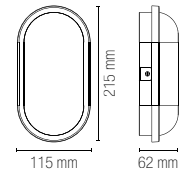

**LED-SHELLY-L BCO**

8031440351713  
FANEU00007378  
lumen

colour temp.	colour

2510 lm

**LED-SHELLY-L ANT**

8031440351690  
FANEU00007377  
lumen

colour temp.	colour

2510 lm

watt	20W
beam angle	120°

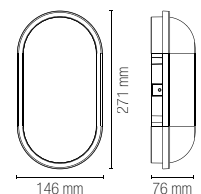

# EVER





**Deckenleuchte aus Polycarbonat mit Basis in den Finishes Weiß oder Anthrazit. Das weiche und minimalistische Design macht sie perfekt für die Verwendung in Indoor- oder Outdoor-Umgebungen. Mit auswählbarem CCT und technischen Eigenschaften für die Installation im Freien.**

Ceiling lamp in polycarbonate with base in white or anthracite finish. Its sleek, minimalist design makes it perfect for both indoor or outdoor spaces. With selectable CCT and technical features for outdoor installation.

**Material**

PC + PC

**Farbe**

Weiß  
Anthrazit



**Farbtemperatur**

3000K / 4000K



**Driver**

eingebaut

**Material**

PC + PC

**Colour**

white  
anthracite



**Colour temperature**

3000K / 4000K



**Driver**

built-in



	colour temp.	colour
<b>LED-EVER-Q-S BCO</b> 8031414862238 FANEU00006198 lumen		
	1870 lm	
<b>LED-EVER-Q-S ANT</b> 8031414862269 FANEU00006197 lumen		
	1900 lm	

	colour temp.	colour
<b>LED-EVER-Q-L BCO</b> 8031414862276 FANEU00006195 lumen		
	3470 lm	
<b>LED-EVER-Q-L ANT</b> 8031414862283 FANEU00006194 lumen		
	3470 lm	

watt	15W
beam angle	120°
pf	-

watt	28W
beam angle	120°
pf	0.90

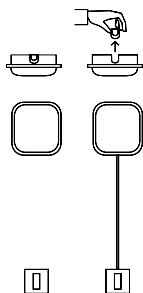
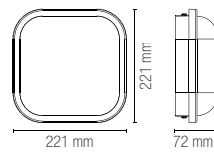
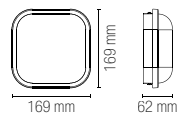

Doppeltes  
Installationssystem /  
Double installation system

**Deckenleuchte mit integrierter LED mit CCT mit zwei Temperaturen. Der Artikel besteht aus Diffusor und Gehäuse aus Polycarbonat in den Farben Weiß und Anthrazit. Mit auswählbarem CCT und technischen Eigenschaften für die Installation im Freien.**

Ceiling lamp with integrated LED, with dual CCT. The product consists of a polycarbonate diffuser and body in white and anthracite. With selectable CCT and technical features for outdoor installation.

**Material**  
PC + PC

**Farbe**  
Weiß  
Anthrazit

**Farbtemperatur**  
3000K / 4000K

**Driver**  
eingebaut

**Material**  
PC + PC

**Colour**  
white  
anthracite

**Colour temperature**  
3000K / 4000K

**Driver**  
built-in



	colour temp.	colour
<b>LED-EVER-LP BCO</b> 8031440355650 FANEU00006193 lumen		
	2500 lm	
<b>LED-EVER-LP ANT</b> 8031440355643 FANEU00006192 lumen		
	2500 lm	

	colour temp.	colour
<b>LED-EVER-XLP BCO</b> 8031440355636 FANEU00006209 lumen		
	3750 lm	
<b>LED-EVER-XLP ANT</b> 8031440355629 FANEU00006208 lumen		
	3750 lm	

watt	20W
beam angle	120°
pf	-

watt	28W
beam angle	120°
pf	0.90

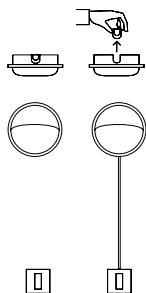
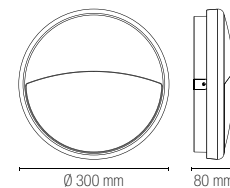
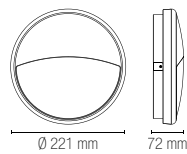

Doppeltes  
Installationssystem /  
Double installation system

**Deckenleuchte mit integrierter LED und zentralem Diffusor und Basis aus Polycarbonat in den Finishs Weiß oder Anthrazit. Für die Anbringung an Decke oder Wand weist sie ein doppeltes Installationssystem auf. Bietet CCT-Beleuchtung mit warmem und neutralem Licht, hohen Sehkomfort und Schutz vor Stößen, Staub und Flüssigkeiten.**

Ceiling lamp with integrated LED, with central diffuser and base in polycarbonate with white or anthracite finish. It features a dual installation system for ceiling or wall mounting. It provides CCT lighting with warm and neutral light, high visual comfort and protection against impacts, dust and liquids.

**Material**

PC + PC

**Farbe**

Weiß  
Anthrazit



**Farbtemperatur**

3000K / 4000K



**Driver**

eingebaut

**Material**

PC + PC

**Colour**

white  
anthracite



**Colour temperature**

3000K / 4000K



**Driver**

built-in

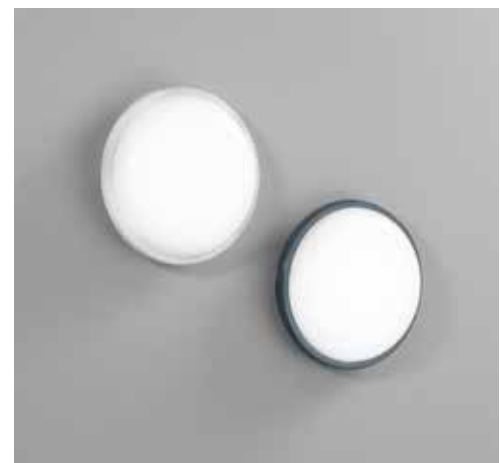
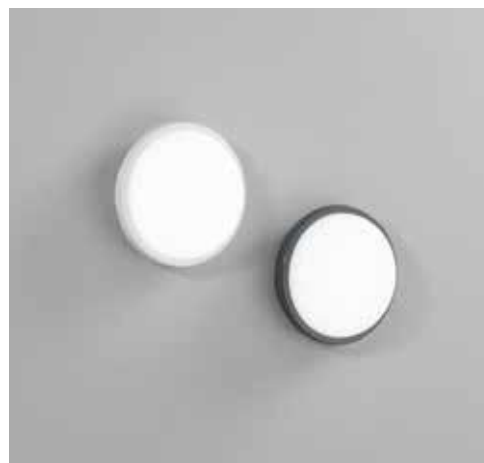

	colour temp.	colour
<b>LED-EVER-S BCO</b> 8031440351683 FANEU00006201 lumen		
	1900 lm	
<b>LED-EVER-S ANT</b> 8031440351638 FANEU00006200 lumen		
	1900 lm	
watt	15W	
beam angle	120°	
pf	-	

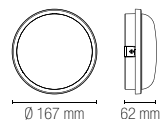

	colour temp.	colour
<b>LED-EVER-L BCO</b> 8031440351676 FANEU00006190 lumen		
	2500 lm	
<b>LED-EVER-L ANT</b> 8031440351645 FANEU00006189 lumen		
	2500 lm	
watt	20W	
beam angle	120°	
pf	0.90	

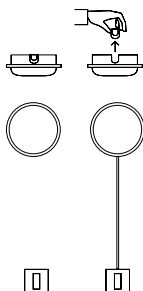
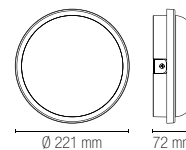

Doppeltes Installationssystem / Double installation system

# EVER





**Die Deckenleuchte Ever in der Maxi-Version, mit CCT-Einstellung der Farbtemperatur, doppeltem Installationssystem an Wand oder Decke, hoher Farbwiedergabe und Schutz vor Stößen, Flüssigkeiten und Staub.**

Ever ceiling lamp in maxi version, with CCT adjustment, dual wall or ceiling installation, high colour rendering and protection against impacts, liquids and dust.

**Material**  
PC + PC

**Farbe**  
Weiß  
Silber



**Farbtemperatur**  
3000K / 4000K



**Driver**  
eingebaut

**Material**  
PC + PC

**Colour**  
white  
silver



**Colour temperature**  
3000K / 4000K



**Driver**  
built-in

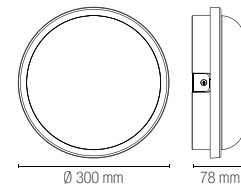

	colour temp.	colour
<b>LED-EVER-XL BCO</b> 8031440355612 FANEU00006203 lumen		
	3750 lm	
<b>LED-EVER-XL SIL</b> 8031440355605 FANEU00006204 lumen		
	3750 lm	
watt	28W	
beam angle	120°	
pf	0.90	

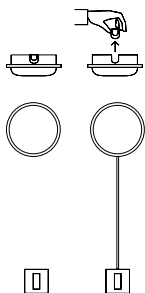

Doppeltes Installationssystem /  
Double installation system

# SPEEDY



**Material**  
PC

**Farbe**  
Weiß



**Farbtemperatur**  
3000K / 4000K



**Driver**  
eingebaut

**Material**  
PC

**Colour**  
white



**Colour temperature**  
3000K / 4000K



**Driver**  
built-in



**Deckenleuchte mit Basis und Diffusor aus weißem Polycarbonat. Mit elegantem und diskretem Design, um sich in Außen- oder Innenbereiche einzufügen, bietet umfassenden Schutz gegen Staub und Beständigkeit gegen Wasserstrahlen aus jeder Richtung.**

Ceiling lamp with white polycarbonate base and diffuser. With an elegant, understated design, for use in outdoor or indoor spaces, it provides full protection against dust and resistance to water jets from any direction.

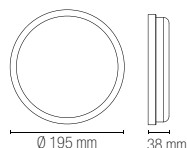

**LED-SPEEDY-18C**

8031414922000  
FANEU00007435  
lumen

colour temp. | colour



1800 lm

watt  
beam angle

18W  
120°

**LED-SPEEDY-18M**

8031414922017  
FANEU00007436  
lumen



1800 lm

watt  
beam angle

18W  
120°

# FLIPPY

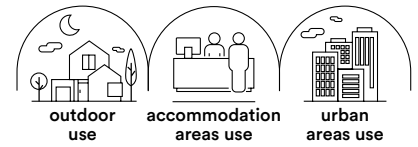

**Material**  
PC

**Farbe**  
Weiß



**Farbtemperatur**  
3000K / 4000K



**Driver**  
eingebaut

**Material**  
PC

**Colour**  
white



**Colour temperature**  
3000K / 4000K



**Driver**  
built-in

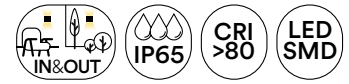

**Deckenleuchte mit Basis und Diffusor aus weißem Polycarbonat. Erhältlich in zwei Farbtemperaturen, bietet Langlebigkeit in Innenumgebungen und hervorragende Beständigkeit gegen Staub und Witterungseinflüsse für die Verwendung in Outdoor-Bereichen.**

Ceiling lamp with white polycarbonate base and diffuser. Available with dual colour temperatures, it provides durability in indoor spaces and optimum protection against dust and atmospheric agents for mounting in outdoor spaces.

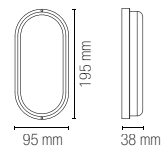

**LED-FLIPPY-12C**  
8031414922024  
FANEU00006228  
lumen

colour temp. | colour

1160 lm

watt 12W  
beam angle 120°

**LED-FLIPPY-12M**  
8031414922031  
FANEU00006229  
lumen

1160 lm

watt 12W  
beam angle 120°

DECKENLEUCHTEN / CEILING LAMPS

In.tec light

# ALYCE





**Deckenleuchte aus UV-beständigem Polycarbonat mit Gehäuse für Sensor mit einstellbarer Bewegungs- und Dämmerungsfunktion. Erhältlich in der weißen oder schwarzen Version, bietet für die sichere Anbringung in öffentlichen Bereichen höchsten Schutz gegen Stöße.**

Anti-UV polycarbonate ceiling light with housing for sensor with adjustable movement and twilight functions. Available in white or black version, it provides maximum protection against impacts for safe installation in public places.

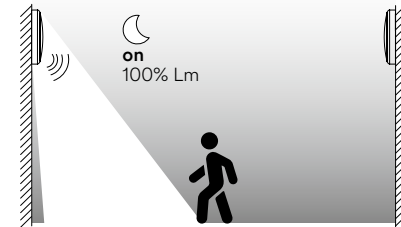

**I-ALYCE-PL-BCO**  
8031414937516  
FANEU00027379

colour



**I-ALYCE-PL-NER**  
8031414937523  
FANEU00027380



1 x E27

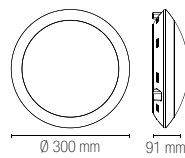

**Bewegungs- und Dämmerungssensor über Schalter regulierbar**

Abstand: 1, 2, 3, 5 Meter  
Einschaltdauer 20 s, 40 s, 5 min, 10 min  
Dämmerungssensor: Tag, 50 Lux, 30 Lux, Nacht /  
**Functions of the motion and crepuscular sensor adjustable via switch**  
distance: 1, 2, 3, 5 meters  
on duration: 20s, 40s, 5 min, 10 min  
crepuscular: day, 50lux, 30lux, night



Sicherheitssperre für den Einsatz des Geräts an öffentlichen Orten /  
Safety lock for using the device in public places

# TURTLE



TURTLE



In.tec light DECKENLEUCHTEN / CEILING LAMPS

# TURTLE

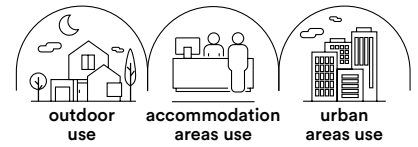

**Weißer oder schwarzer Deckenleuchte mit Struktur aus Thermoplast und Diffusor aus Glas. Erhältlich mit runder oder ovaler Form, in verschiedenen Modellen mit verschiedenen Geometrien für das Gitter ausgelegt, um sich an den architektonischen Stil anzupassen.**

Ceiling lamp in white or black with thermoplastic fixture and glass diffuser. Available in circular or oval shape, it comes in several versions with different grid shapes to match the architectural style.



	colour
<b>I-TURTLE-AP-B-BCO</b> 8031414935413 FANEU00026252	●
<b>I-TURTLE-AP-B-NER</b> 8031414935420 FANEU00026253	●

1 x E27

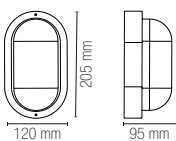

	colour
<b>I-TURTLE-AP-P-BCO</b> 8031414935437 FANEU00026255	●
<b>I-TURTLE-AP-P-NER</b> 8031414935444 FANEU00026254	●

1 x E27

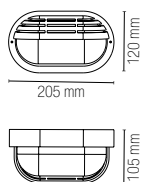

	colour
<b>I-TURTLE-AP-BCO</b> 8031414918577 FANEU00003873	●
<b>I-TURTLE-AP-NER</b> 8031414918560 FANEU00003875	●

1 x E27

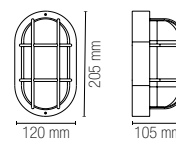

Glühbirne nicht  
enthalten /  
Light bulb  
not included

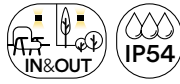

colour

**I-TURTLE-PL-B-BCO**  
8031414935451  
FANEU00026256



**I-TURTLE-PL-B-NER**  
8031414935468  
FANEU00026257



1 x E27

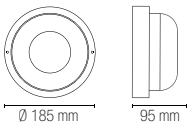

colour

**I-TURTLE-PL-P-BCO**  
8031414935475  
FANEU00026258



**I-TURTLE-PL-P-NER**  
8031414935482  
FANEU00026259



1 x E27

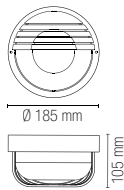

colour

**I-TURTLE-PL-BCO**  
8031414918553  
FANEU00003877



**I-TURTLE-PL-NER**  
8031414918546  
FANEU00003879



1 x E27

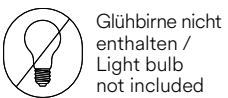
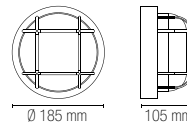

Glühbirne nicht  
enthalten /  
Light bulb  
not included





**Kombinierte Wand-, Hänge- und Bodenleuchten / Wall, suspension and floor lamps combined  
outdoor**

# KHALIFA



---

**Material**

Aluminium

---

**Farbe**

Geprägt, Anthrazit

---

**Wählbare****Farbtemperatur**

3000K / 3500K / 4000K

---

**Driver**

eingebaut

---

**Material**

aluminum

---

**Colour**

embossed anthracite

---

**Selectable color  
temperature**

3000K / 3500K / 4000K

---

**Driver**

built-in

---





**Kollektion aus Aluminiumdruckguss mit integrierter LED und auswählbarer Farbtemperatur. Umfasst auch ein Modell mit 2 Metern Höhe, dessen idealer Verwendungsort Beherbergungsbetriebe wie Restaurants und Hotels sind.**

A collection in die-cast aluminium with integrated LED and selectable colour temperature. It also includes a 2-metre high version, ideal for hospitality spaces such as restaurants and hotels.



**LED-KHALIFA-P100**

8031414949014  
FANEU00028507  
lumen

colour temp.	colour

3683 lm

watt	25W
beam angle	280°

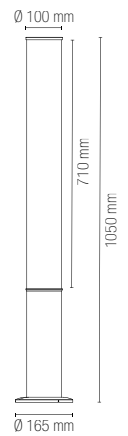

**LED-KHALIFA-P200**

8031414949021  
FANEU00028508  
lumen

colour temp.	colour

5379 lm

watt	43W
beam angle	280°

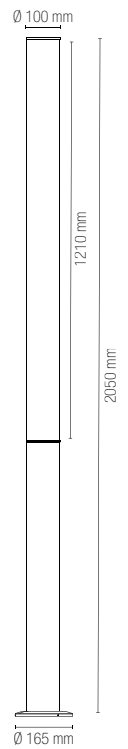

# NEEDLE



**Material**  
Aluminium

**Farbe**  
Geprägt, Anthrazit  
Geprägt, Corten



**Wählbare  
Farbtemperatur**  
3000K



**Driver**  
eingebaut

**Material**  
aluminium

**Colour**  
embossed anthracite  
embossed corten



**Selectable color  
temperature**  
3000K



**Driver**  
built-in





**Kollektion aus Aluminiumdruckguss mit integrierter LED. Erhältlich in den geprägten Finishs Anthrazit oder Corten, bietet auch eine Version mit kompakten Abmessungen, die als Orientierungsleuchte konzipiert ist.**

A collection in die-cast aluminium with integrated LED. Available in anthracite or corten embossed finish, it also comes in a compact version designed as a step light.



	colour temp.	colour
<b>LED-NEEDLE-P30-ANT</b>		
8031414949038		
FANEU00028509		
lumen	623 lm	
<b>LED-NEEDLE-P30-BRO</b>		
8031414949045		
FANEU00028510		
lumen	623 lm	
watt		6W
beam angle		142°

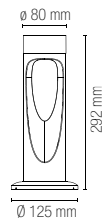

	colour temp.	colour
<b>LED-NEEDLE-P80-ANT</b>		
8031414949052		
FANEU00028511		
lumen	623 lm	
<b>LED-NEEDLE-P80-BRO</b>		
8031414949069		
FANEU00028512		
lumen	623 lm	
watt		6W
beam angle		142°

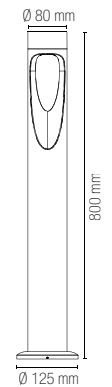

# LUMINA

Abwechslungsreiche Kollektion aus Metall in der Farbe Anthrazit mit integriertem LED-Lichtpunkt. Ideal für moderne und elegante Stadt- oder Gewerbebereiche. In der Wandleuchtenversion kann Lumina auch als Orientierungsleuchte eingesetzt werden.

A mixed collection in metal with anthracite finish, with integrated LED light point. Ideal for urban spaces or elegant, modern retail spaces. In the wall version, Lumina can also be used as a wall light.



**Material**

Aluminium

**Farbe**

anthracite



**Farbtemperatur**

3000K / 4000K



**Driver**

eingebaut

**Material**

aluminum

**Colour**

anthracite



**Colour temperature**

3000K / 4000K



**Driver**

built-in





**LED-LUMINA-AP**  
8031414922864  
FANEU00025981  
lumen

colour temp. colour  
1476 lm

watt 12W  
beam angle 120°  
pf -

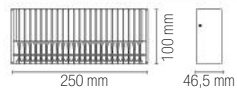

**LED-LUMINA-P40**  
8031414935871  
FANEU00027279  
lumen

colour temp. colour  
1400 lm

watt 11W  
beam angle 220°  
pf -

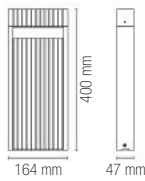

**LED-LUMINA-P80**  
8031414922871  
FANEU00027280  
lumen

colour temp. colour  
1400 lm

watt 11W  
beam angle 120°

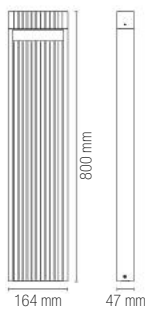

**LED-LUMINA-P230**  
8031414922888  
FANEU00027281  
lumen

colour temp. colour  
3500 lm

watt 26W  
beam angle 120°  
pf 0.90

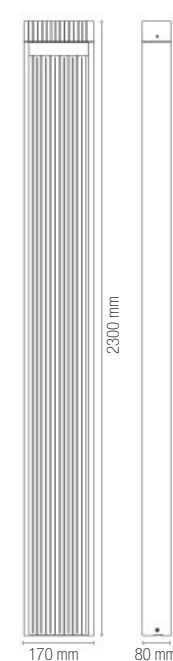

---

**Material**

Aluminium

---

**Farbe**

Geprägt, Anthrazit  
Geprägt, Corten



---

**Wählbare Farbtemperatur**  
3000K / 4000K

---

**Driver**

eingebaut

---

**Material**

aluminium

---

**Colour**

embossed anthracite  
embossed corten



---

**Selectable color temperature**  
3000K / 4000K

---

**Driver**

built-in

---

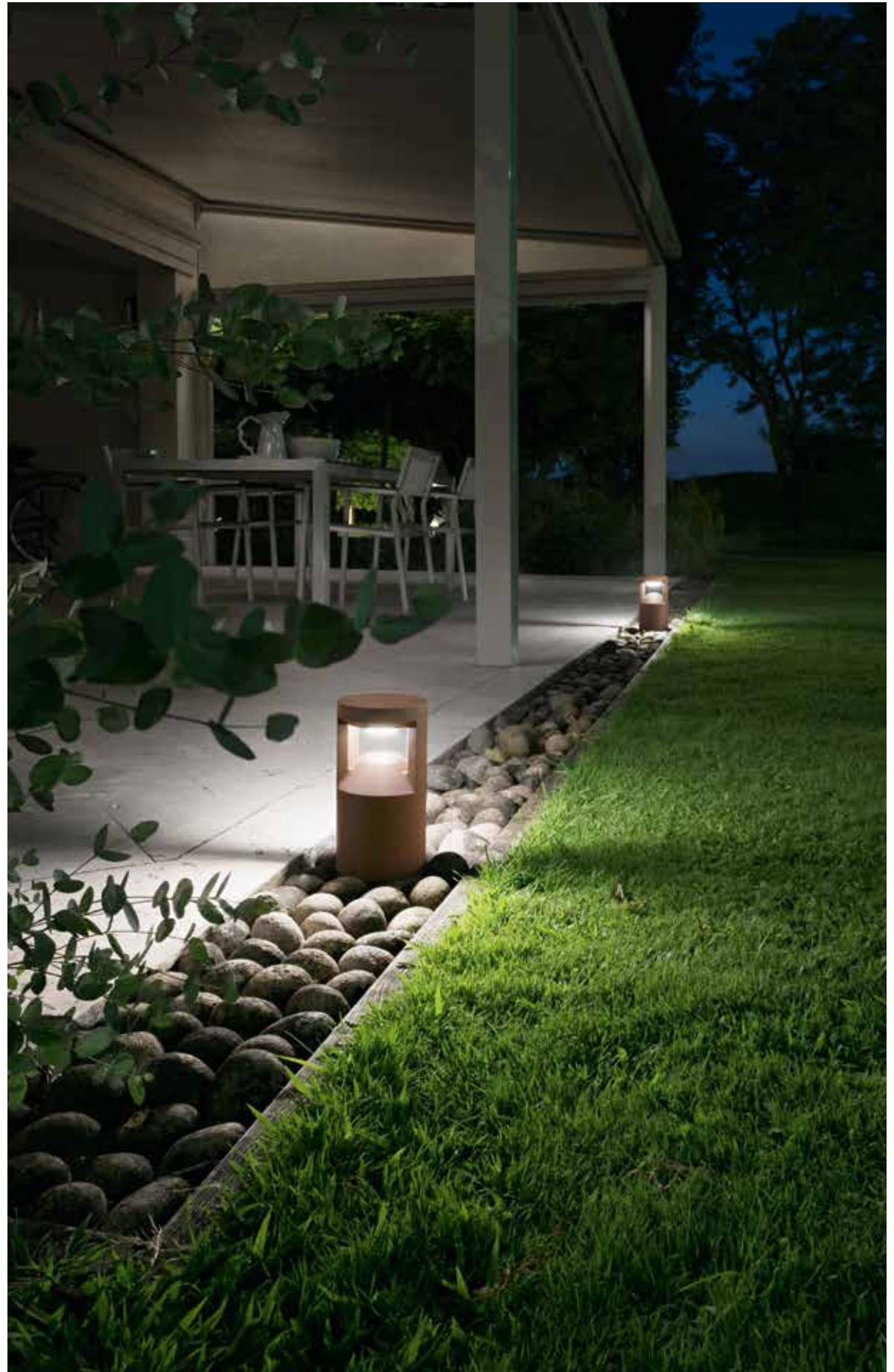



**Kollektion aus Aluminiumdruckguss mit integrierter LED und auswählbarer Farbtemperatur. In den Farben Anthrazit oder geprägtem Corten, um sich diskret einzufügen, garantiert optimalen Schutz vor Stößen und Witterungseinflüssen.**

A collection in die-cast aluminium with integrated LED and selectable colour temperature. Available in anthracite or corten embossed finish for subtle integration, it ensures excellent protection against impacts and atmospheric agents.



	colour temp.	colour	
<b>LED-WAMI-AP-ANT</b> 8031414890026 FANEU00007907			
lumen	1530 lm		
<b>LED-WAMI-AP-BRO</b> 8031414890057 FANEU00007908			
lumen	1530 lm		
watt	12W		
beam angle	120°		

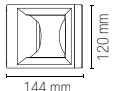
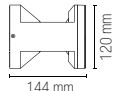

	colour temp.	colour	
<b>LED-WAMI-P25-ANT</b> 8031414890033 FANEU00007911			
lumen	1530 lm		
<b>LED-WAMI-P25-BRO</b> 8031414890064 FANEU00007912			
lumen	1530 lm		
watt	12W		
beam angle	120°		

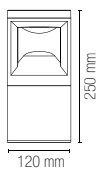
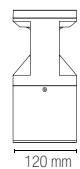

	colour temp.	colour	
<b>LED-WAMI-P80-ANT</b> 8031414890040 FANEU00007913			
lumen	1530 lm		
<b>LED-WAMI-P80-BRO</b> 8031414890071 FANEU00007914			
lumen	1530 lm		
watt	12W		
beam angle	120°		

# MOBULA

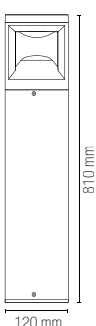
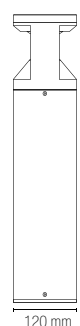

---

**Material**

Aluminium

---

**Farbe**

Geprägt, Weiß  
Geprägt, Anthrazit  
Geprägt, Corten



---

**Wählbare  
Farbtemperatur**

3000K



---

**Driver**

inklusive

---

**Material**

aluminium

---

**Colour**

embossed white  
embossed anthracite  
embossed corten



---

**Selectable color  
temperature**

3000K



---

**Driver**

included





**LED-Wand- oder Bodenleuchte aus Metall mit minimalistischem und erlesenem Design, das durch die drei Farbvarianten verstärkt wird: Weiß, Anthrazit oder Bronze. Bietet hohe Farbwiedergabe und Schutz vor Stößen, Staub und Flüssigkeiten.**

LED wall lamp and bollard light in metal with a sophisticated and minimalist design, enhanced in three colour versions: white, anthracite or bronze. It provides high colour rendering and protection against impacts, dust and liquids.



	colour temp.	colour
<b>LED-MOBULA-AP-BCO</b> 8031414931552 FANEU00027315 lumen	1100 lm	
<b>LED-MOBULA-AP-ANT</b> 8031414931569 FANEU00027314 lumen	1100 lm	
<b>LED-MOBULA-AP-BRO</b> 8031414931576 FANEU00027316 lumen	1100 lm	
watt		8W
beam angle		120°

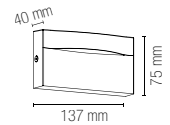

	colour temp.	colour
<b>LED-MOBULA-P70-BCO</b> 8031414931583 FANEU00027318 lumen	1100 lm	
<b>LED-MOBULA-P70-ANT</b> 8031414931590 FANEU00027317 lumen	1100 lm	
<b>LED-MOBULA-P70-BRO</b> 8031414931606 FANEU00027319 lumen	1100 lm	
watt		8W
beam angle		120°

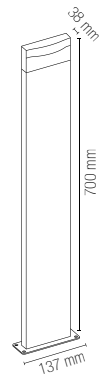

# SAIL



**Material**  
Aluminium

**Farbe**  
Geprägt, Weiß  
Geprägt, Anthrazit



**Farbtemperatur**  
3000K / 4000K



**Driver**  
eingebaut

**Material**  
aluminum

**Colour**  
embossed white  
embossed anthracite



**Colour temperature**  
3000K / 4000K



**Driver**  
built-in





**Kollektion aus Aluminium im Finish Weiß oder geprägtes Anthrazit mit integrierter LED und zwei wählbaren Farbtemperaturen. Das besondere Design wird als Boden- und Wandleuchte ausgelegt, auch mit Bewegungssensoren erhältlich.**

A collection in aluminium with white or anthracite finish, with integrated LED and selectable dual colour temperatures. A unique design in a bollard light or wall lamp version, also available with motion sensors.



	colour temp.	colour
<b>LED-SAIL-AP-BCO</b> 8031414918614 FANEU00007319 lumen		
<b>LED-SAIL-AP-ANT</b> 8031414920174 FANEU00007318 lumen		
watt	12W	
beam angle	180°	

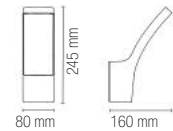

	colour temp.	colour
<b>LED-SAIL-APS-BCO</b> 8031414920181 FANEU00007322 lumen		
<b>LED-SAIL-APS-ANT</b> 8031414918621 FANEU00007321 lumen		
watt	12W	
beam angle	180°	

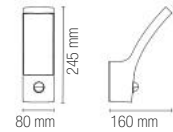

**Enthaltenes Zubehör / Accessories included**

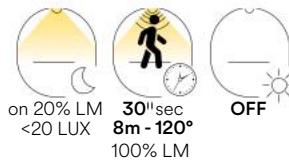

Bewegungssensor maximale Entfernung 6m, 120° / Motion sensor maximum distance 6m, 120°



	colour temp.	colour
<b>LED-SAIL-P90-BCO</b> 8031414918638 FANEU00007326 lumen		
<b>LED-SAIL-P90-ANT</b> 8031414918645 FANEU00007325 lumen		
watt	12W	
beam angle	180°	

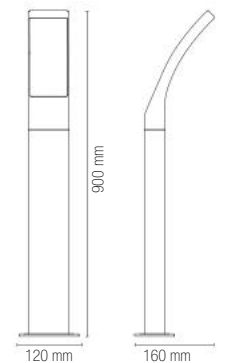

# DISCOVERY

**Kollektion mit integrierter Led aus Aluminium mit geprägtem anthrazitfarbenem Finish.**

**Garantiert eine extrem hohe Farbwiedergabe und Schutz vor Staub, Wasser und Stößen.**

**Die Bodenversion ist mit doppeltem Versorgungsanschluss ausgestattet.**

A collection with integrated LED in aluminium with anthracite embossed finish. Excellent colour rendering and protection against dust, water and impacts. The bollard light version is fitted with a dual power socket.



DISCOVERY



In.tec light KOMBINIERTE WAND-, HÄNGE- UND BODENLEUCHTEN / WALL, SUSPENSION AND FLOOR LAMPS COMBINED





- Material**  
Aluminium
- Farbe**  
Geprägt, Anthrazit
- 
- Farbtemperatur**  
4000K
- 
- Driver**  
eingebaut

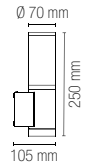

<b>LED-DISCOVERY-AP</b> 8031414877836 FANEU00006048	colour temp.	colour
lumen	1440 lm	
watt	13W	
beam angle	360°	



- Material**  
aluminum
- Colour**  
embossed anthracite
- 
- Colour temperature**  
4000K
- 
- Driver**  
built-in



<b>LED-DISCOVERY-P65</b> 8031414877850 FANEU00006056	colour temp.	colour
lumen	1440 lm	
watt	13W	
beam angle	360°	



<b>LED-DISCOVERY-HUB</b> 8031414877867 FANEU00006050	colour temp.	colour
lumen	1440 lm	
watt	13W	
beam angle	360°	
	Plug 2X max 15A 250V 2500W	

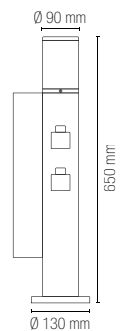

# IDEM



Lampe aus Aluminium mit integrierter LED und hoher Farbwiedergabe mit Finish aus geprägtem Anthrazit. Sowohl in der Wand- als auch in der Bodenlampenvariante sind die Lichtpunkte mit einer Neigung von bis zu 180° verstellbar.

Lamp with integrated LED in aluminium, with high colour rendering and anthracite embossed finish. The wall lamp and the bollard light version feature adjustable light points, allowing tilting up to 180°.

- Material**  
Aluminium
- Farbe**  
Geprägt, Anthrazit
- Farbtemperatur**  
4000K
- Driver**  
eingebaut
- Material**  
aluminium
- Colour**  
embossed anthracite
- Colour temperature**  
4000K
- Driver**  
built-in

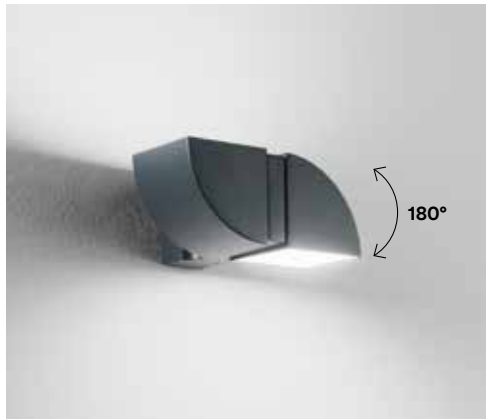

**LED-IDEM-AP**  
8031414883103  
FANEU00006453  
lumen

colour temp.	colour
●	●
840 lm	

watt	8W
beam angle	120°

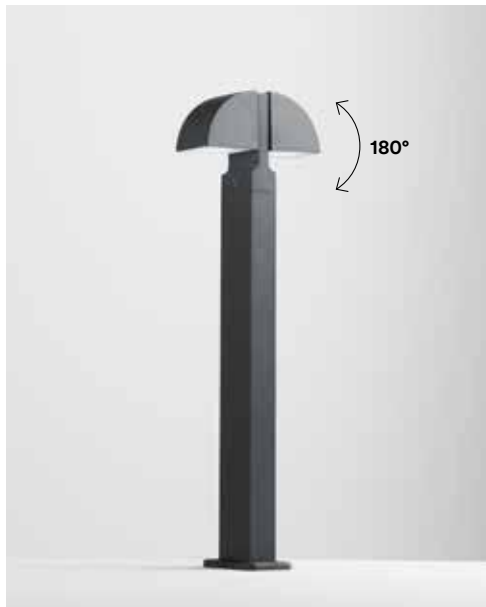
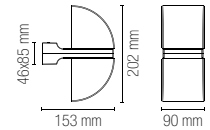

**LED-IDEM-P1**  
8031414883110  
FANEU00006454  
lumen

colour temp.	colour
●	●
840 lm	

watt	8W
beam angle	120°

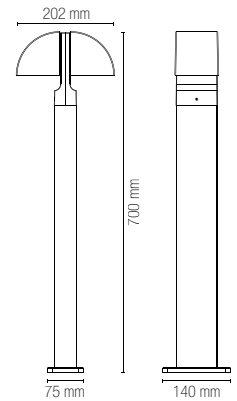

# REVERSE



Lampe aus Aluminium mit integrierter LED und geprägtem anthrazitfarbenem Finish. Ihr stark prägender Stil ist in der Boden- oder Wandleuchtenversion mit verstellbarem Lichtpunkt zum Ausrichten des Lichtstrahls zu finden.

Lamp with integrated LED in aluminium with anthracite embossed finish. A striking style for a bollard light or wall light version, with adjustable light point to direct the beam.

**Material**

Aluminium

**Farbe**

Geprägt, Anthrazit



**Farbtemperatur**

4000K



**Driver**

eingebaut

**Material**

aluminium

**Colour**

embossed anthracite



**Colour temperature**

4000K



**Driver**

built-in

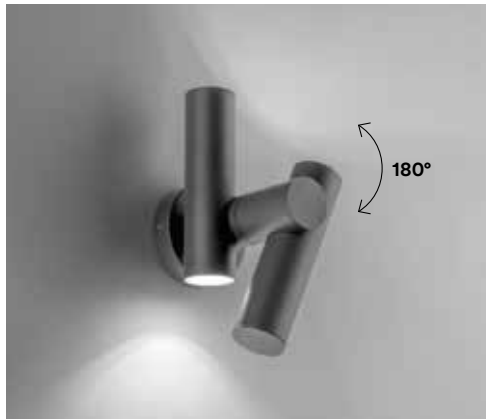

**LED-REVERSE-AP**

8031414883127  
FANEU00007266  
lumen

colour temp.	colour
620 lm	

watt	7,5W
beam angle	120°

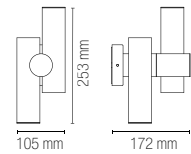

**LED-REVERSE-P1**

8031414883134  
FANEU00007267  
lumen

colour temp.	colour
460 lm	

watt	5,3W
beam angle	120°

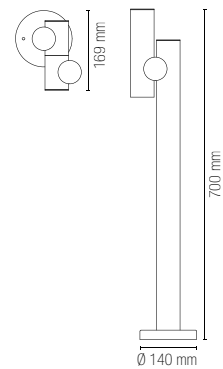



---

**Material**

Aluminium

---

**Farbe**

Geprägt, Anthrazit  
Geprägt, Corten



---

**Wählbare Farbtemperatur**

3000K / 4000K



---

**Driver**

eingebaut

---

**Material**

aluminum

---

**Colour**

embossed anthracite  
embossed corten



---

**Selectable color temperature**

3000K / 4000K



---

**Driver**

built-in

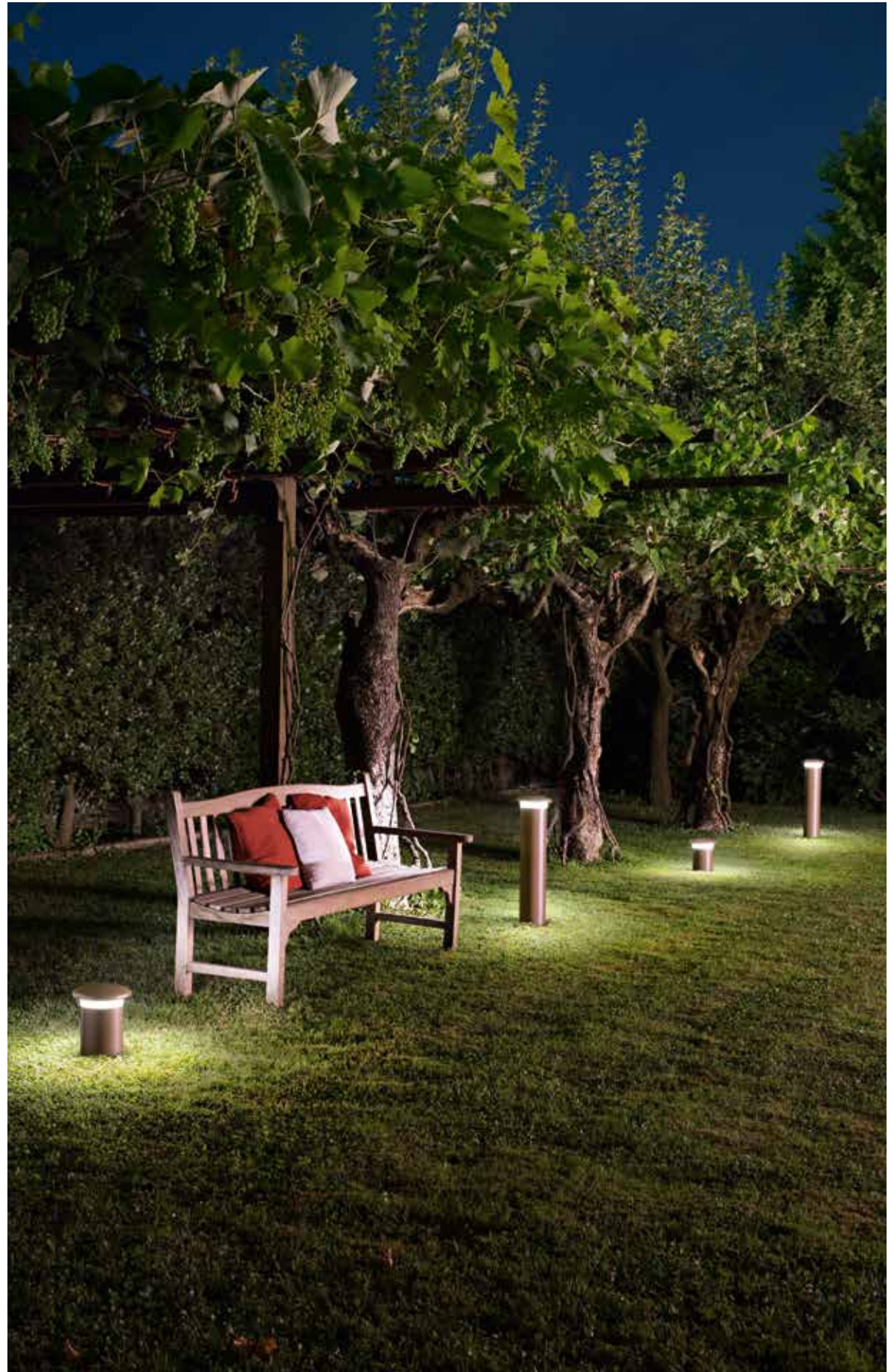



**Leuchte aus Aluminium in den Finish Anthrazit und geprägtes Corten mit integrierter LED und verstellbarer Lichttemperatur. Die ideale Wahl für die Außenbereiche von Beherbergungsstrukturen oder Stadtparks, bietet optimalen Schutz vor Staub, Flüssigkeiten und Stößen.**

Lamp with integrated LED in aluminium with anthracite or corten embossed finish and adjustable light temperature. The ideal choice for the exteriors of hospitality facilities or urban parks, it provides excellent protection against dust, liquids and impacts.



	colour temp.	colour
<b>LED-BITT-P28-ANT</b> 8031414883011 FANEU00005862 lumen	1200 lm	
<b>LED-BITT-P28-BRO</b> 8031414883028 FANEU00005863 lumen	1200 lm	
watt		10W
beam angle		120°

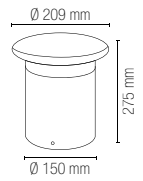

	colour temp.	colour
<b>LED-BITT-P76-ANT</b> 8031414883035 FANEU00005864 lumen	1200 lm	
<b>LED-BITT-P76-BRO</b> 8031414883042 FANEU00005865 lumen	1200 lm	
watt		10W
beam angle		120°

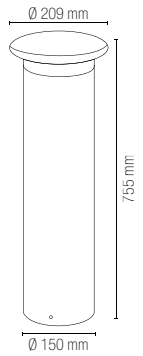





**Kollektion aus Aluminium mit integrierter LED und zwei auswählbaren Farbtemperaturen. Das Gehäuse von Wand- und Bodenlampe zeigt sich im geprägten Total-White-Finish, um sich harmonisch in moderne und prestigereiche Beherbergungsbetriebe einzufügen.**

A collection in aluminium with integrated LED, with selectable colour temperatures. The wall light and bollard light fixture have a total white embossed finish to perfectly blend in with prestigious modern hospitality facilities.

- Material**  
Aluminium

---

- Farbe**  
Geprägt, Weiß

---

- Wählbare Farbtemperatur**  
3000K / 4000K

---

- Driver**  
eingebaut

---

- Material**  
aluminum

---

- Colour**  
embossed white

---

- Selectable color temperature**  
3000K / 4000K

---

- Driver**  
built-in



	colour temp.	colour
<b>LED-NISMO-AP</b> 8031440361224 FANEU00006862 lumen		
	1430 lm	

	colour temp.	colour
<b>LED-NISMO-P60</b> 8031440361231 FANEU00006864 lumen		
	1430 lm	

watt	12W
beam angle	120°

watt	12W
beam angle	120°

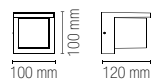

# BOOSTER





**Kollektion aus Metall mit silbernem Finish in den Varianten als Wand- oder Bodenleuchte. Die moderne und elegante Booster kann sich harmonisch in zeitgemäße städtische Umgebungen oder Außen- und Durchgangsbereiche einfügen.**

A collection in metal with silver finish in a wall lamp and bollard light version. Modern and elegant, Booster harmoniously blends in with contemporary urban spaces, outdoor areas and walk-through areas.



Glühlampe nicht enthalten /  
Light bulb not included



**I-BOOSTER-AP**  
8031414918492  
FANEU00001312

colour



1 x E27 MAX 40W

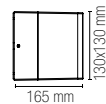

**I-BOOSTER-P60**  
8031414918508  
FANEU00001314

colour



1 x E27 MAX 40W

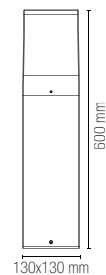

# UNDERWOOD





**Kollektion aus Metall mit Finish in Anthrazit oder Corten, konzipiert zum Einfügen in besonders gepflegte Außenumgebungen. Mit umfassendem Schutz vor Staub und hervorragendem Spritzschutz.**

A collection in metal with anthracite or corten finish designed for installation in elegant outdoor spaces. With full protection against dust and excellent protection against splashes.



Glühbirne nicht enthalten / Light bulb not included



colour

**I-UNDERWOOD-P70-ANT**

8031414883059

FANEU00003885

**I-UNDERWOOD-P70-BRO**

8031414883066

FANEU00003886

4 x G9 MAX 10W

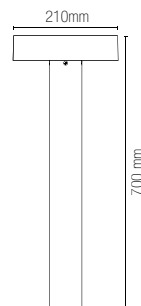

# FOCUS

Kollektion von Wand- und Bodenleuchten aus Polycarbonat, erhältlich in den Farben Weiß und Schwarz und in der rechteckigen oder runden Variante. Für hervorragende Beständigkeit aus korrosionsfesten Materialien mit einem hohen Schutzgrad vor Witterungseinflüssen hergestellt.

A collection of polycarbonate wall lamps and bollard lights, available in black or white and in a square or round version. Made of anti-corrosive materials, it provides high protection against external agents, ensuring optimum durability.

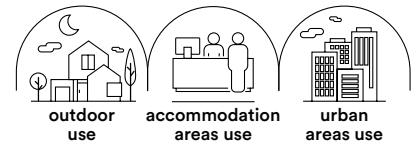

colour

**I-FOCUS-R-AP-BCO**

8031414916290  
FANEU00001965



**I-FOCUS-R-AP-NER**

8031414916283  
FANEU00001966



1 x GU10 MAX 35W

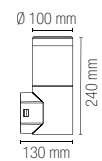

Glühbirne nicht enthalten/  
Light bulb not included



**I-FOCUS-Q-AP-BCO**

8031414916313  
FANEU00001961



**I-FOCUS-Q-AP-NER**

8031414916306  
FANEU00001962



1 x GU10 MAX 35W

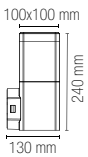

**I-FOCUS-R-P-BCO**

8031414916252  
FANEU00001967



**I-FOCUS-R-P-NER**

8031414916245  
FANEU00001968



1 x GU10 MAX 35W

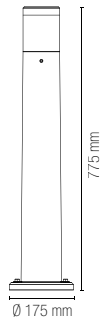

**I-FOCUS-Q-P-BCO**

8031414916276  
FANEU00001963



**I-FOCUS-Q-P-NER**

8031414916269  
FANEU00001964



1 x GU10 MAX 35W

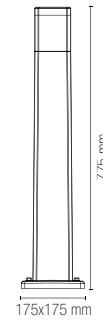

Nicht enthaltenes Zubehör /  
Accessory not included



**I-FOCUS-SPK**  
8031414929481  
FANEU00027081

Zubehör für  
Befestigung mit Pflock /  
Accessory for peg fixing

# DARK

Kollektion aus Thermoplast im Farbton Anthrazit mit Diffusor aus Polycarbonat. Diskrete und funktionelle Boden- und Wandleuchten mit einstellbarem integriertem Bewegungssensor für die Beleuchtung von städtischen Bereichen oder Räumlichkeiten von Beherbergungsbetrieben.

A collection in anthracite thermoplastic with a polycarbonate diffuser. Understated and functional bollard lights and wall lamps feature an adjustable integrated motion sensor to illuminate urban areas and hospitality spaces.

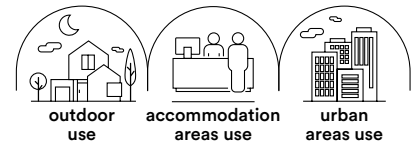

colour

**I-DARK-AP1**  
8031414918775  
FANEU00001561

1 x E27 MAX 25W

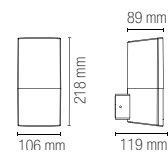

**I-DARK-AP1-S**  
8031414919093  
FANEU00001562

1 x E27 MAX 25W

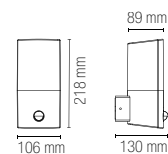

**Enthaltenes Zubehör / Accessories included**

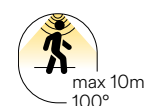

Regulierbarer Bewegungssensor  
max. Abstand 10 m 100° /  
Adjustable motion sensor  
max distance 10m 100°



colour

**I-DARK-AP2**  
8031414919109  
FANEU00001563



2 x E27 MAX 25W

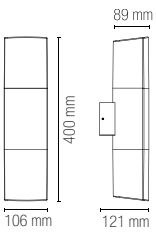

colour

**I-DARK-APV**  
8031414919116  
FANEU00001564



1 x E27 MAX 25W

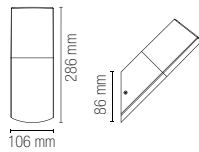

colour

**I-DARK-P1**  
8031414918782  
FANEU00001566



1 x E27 MAX 25W

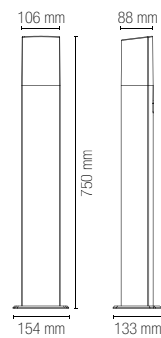

Glühbirne nicht enthalten /  
Light bulb not included

# TOKYO

Erlesene Kollektion aus Edelstahl mit Diffusor aus Polycarbonat. Vielseitig und komplett, umfasst Wand- und Bodenleuchten in verschiedenen Größen, die durch Finishes in Weiß, Bronze, gebürstetem Nickel und Anthrazit veredelt werden.

A sophisticated collection in stainless steel with a polycarbonate diffuser. Versatile and complete, it includes wall lamps and bollard lights in various sizes, embellished with white, bronze, brushed nickel or anthracite finish.

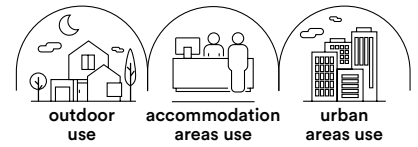

TOKYO



In.tec light KOMBINIERTE WAND-, HÄNGE- UND BODENLEUCHTEN / WALL-, SUSPENSION AND FLOOR LAMPS COMBINED

# TOKYO



		colour	
	<b>I-TOKYO-AP BCO</b> 8031414864447 FANEU00003808		
	<b>I-TOKYO-AP ANT</b> 8031414888795 FANEU00003807		
	<b>I-ST021</b> 8031421451081 FANEU00003702		
	<b>I-TOKYO-AP BRO</b> 8031414864423 FANEU00003809		
1 x E27 MAX 40W			
	Empfohlene Glühbirne / Suggested light bulb		
	Glühbirne nicht enthalten / Light bulb not included		



	colour
<b>I-TOKYO-P45 BCO</b> 8031414935512 FANEU00026242	
<b>I-TOKYO-P45 ANT</b> 8031414935505 FANEU00026241	
<b>I-ST022-450</b> 8031414935499 FANEU00026294	
<b>I-TOKYO-P45 BRO</b> 8031414935529 FANEU00026243	

1 x E27 MAX 40W



	colour
<b>I-TOKYO-P70 BCO</b> 8031414875320 FANEU00003816	
<b>I-TOKYO-P70 ANT</b> 8031414888818 FANEU00003815	
<b>I-ST022-700</b> 8031414877225 FANEU00003704	
<b>I-TOKYO-P70 BRO</b> 8031414871780 FANEU00003817	

1 x E27 MAX 40W



	colour
<b>I-TOKYO-P BCO</b> 8031414864416 FANEU00003813	
<b>I-TOKYO-P ANT</b> 8031414888801 FANEU00003812	
<b>I-ST022-1100</b> 8031421661084 FANEU00003703	
<b>I-TOKYO-P BRO</b> 8031414864393 FANEU00003814	

1 x E27 MAX 40W

# STATION





**Kollektion mit Gehäuse aus Stahl und anthrazitfarbenem Finish. Essenziell und erlesen und als Bodenleuchte in Kombination mit dem Diffusor aus weißem Polycarbonat oder als Versorgungssäule mit doppelter Steckdose erhältlich.**

A collection with a steel fixture and anthracite finish. Minimalist and elegant, it comes in a bollard light version with a white polycarbonate diffuser or in a service column version with a dual socket.



Glühbirne nicht enthalten /  
Light bulb not included



**I-STATION-E27-SC2**

8031414879571  
FANEU00003707

colour



1 x E27 MAX 60W



Plug 2X max 15A 250V 2500W

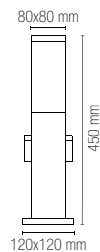

**I-STATION-SC2**

8031414879564  
FANEU00003708

colour



Plug 2X max 15A 250V 2500W

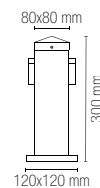

# MIRAGE

Laterne aus Metall in Weiß oder Anthrazit mit Diffusor aus transparentem Glas. Das gleiche Design wird für zahlreiche Lösungen verwendet: Wand- bzw. Hängeleuchte, Stehlampe, Bodenleuchte oder Laterne.

Lantern in metal with a white or anthracite finish, with transparent glass diffuser. The same design is available as various solutions: wall lamp, pendant light, floor lamp, bollard light or street lamp.

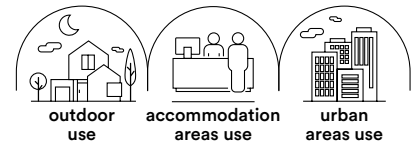

colour

### LANT-MIRAGE-AP-BCO

8031414896394  
FANEU00005601

### LANT-MIRAGE-AP

8031414867059  
FANEU00005600

1 x E27 MAX 60W

130 x 130 mm

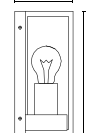

Glühbirne nicht enthalten /  
Light bulb not included



	colour
<b>LANT-MIRAGE-S1-BCO</b> 8031414896431 FANEU00005612	
<b>LANT-MIRAGE-S1</b> 8031414867066 FANEU00005611	

1 x E27 MAX 60W

	colour
<b>LANT-MIRAGE-L1-BCO</b> 8031414896400 FANEU00005604	
<b>LANT-MIRAGE-L1</b> 8031414869190 FANEU00005603	

1 x E27 MAX 60W

	colour
<b>LANT-MIRAGE-P90-BCO</b> 8031414896424 FANEU00005610	
<b>LANT-MIRAGE-P90</b> 8031414869206 FANEU00005609	

1 x E27 MAX 60W

	colour
<b>LANT-MIRAGE-P200-BCO</b> 8031414896417 FANEU00005607	
<b>LANT-MIRAGE-P200</b> 8031414869213 FANEU00005606	

1 x E27 MAX 60W

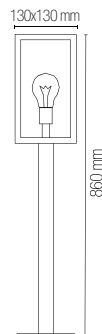
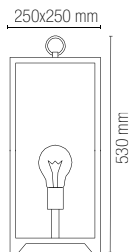
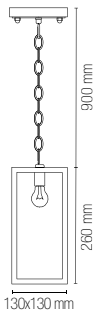

**Enthaltenes Zubehör / Accessories included**



2,5 m Kabel mit Schukostecker / 2,5 m of cable with schuko plug



# SKITTLE

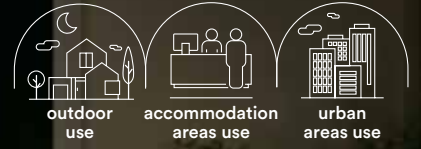



**Collezione in alluminio pressofuso colore antracite con diffusore in PC. Sobria ma non banale, la collezione è disponibile in diverse varianti per offrire molteplici soluzioni in armonia con le aree esterne.**

Collezione in alluminio pressofuso colore antracite con diffusore in PC. Sobria ma non banale, la collezione è disponibile in diverse varianti per offrire molteplici soluzioni in armonia con le aree esterne.



colour

**I-SKITTLE-AP**  
8031414881819  
FANEU00003618



1 x E27 MAX 28W

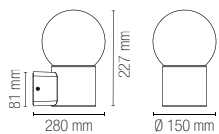

colour

**I-SKITTLE-PL**  
8031414881826  
FANEU00003622



1 x E27 MAX 28W

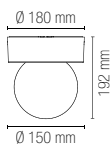

colour

**I-SKITTLE-P65**  
8031414881833  
FANEU00003621



1 x E27 MAX 28W



colour

**I-SKITTLE-P100**  
8031414882434  
FANEU00003620



1 x E27 MAX 28W

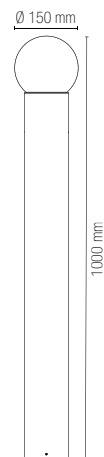

Empfohlene Glühbirne / Suggested light bulb



Glühbirne nicht enthalten / Light bulb not included

# ASSISI





**Eine Kollektion, die Originalität und Eleganz verbindet und im Design als Wand- und Bodenleuchte ausgelegt ist, erhältlich in den Varianten in Weiß, Anthrazit und Bronze. Ein Modell, das dazu gedacht ist, sich makellos in gehobene Außenbereiche einzufügen.**  
 A collection combining uniqueness with elegance, extending its design to include a LED wall light and a bollard light, available in a white, anthracite and bronze version. A model designed to blend seamlessly into elegant outdoor settings.



	colour
<b>LANT-ASSISI-AP1-BCO</b> 8031414950300 FANEU00028681	
<b>LANT-ASSISI-AP1-NER</b> 8031414946464 FANEU00028570	
<b>LANT-ASSISI-AP1-BRO</b> 8031414950317 FANEU00028682	

1 x E27 MAX 15W



	colour
<b>LANT-ASSISI-P1-BCO</b> 8031414950324 FANEU00028683	
<b>LANT-ASSISI-P1-NER</b> 8031414946471 FANEU00028571	
<b>LANT-ASSISI-P1-BRO</b> 8031414950331 FANEU00028684	

1 x E27 MAX 15W

# ROMA



Umfassende Kollektion von Laternen aus Aluminiumdruckguss mit Diffusor aus transparentem Glas. Roma ist in zahlreichen Varianten erhältlich und eine dekorative Wahl mit starker Wirkung, die über die technische Funktion hinausgeht. A complete collection of lanterns in die-cast aluminium with transparent glass diffuser. Available in various versions, Roma is a decorative choice with striking appeal that goes beyond its technical function.



colour

### LANT-ROMA/AP1A BCO

8031434661217  
FANEU00005643



### LANT-ROMA/AP1A

8031430751172  
FANEU00005642



1 x E27 MAX 60W



colour

### LANT-ROMA/AP1A-S

8031435921235  
FANEU00005644



1 x E27 MAX 60W



colour

### LANT-ROMA/AP1B BCO

8031434671216  
FANEU00005646



### LANT-ROMA/AP1B

8031430761171  
FANEU00005645



1 x E27 MAX 60W



colour

### LANT-ROMA/S1 BCO

8031434681215  
FANEU00005652



### LANT-ROMA/S1

8031430791178  
FANEU00005651



1 x E27 MAX 60W



Eingebautes Zubehör /  
Built in accessories



Regulierbarer  
Bewegungssensor /  
Adjustable motion sensor

ON	10lux
Abstand / distance	1-8m
	90°
5 seconds - 5 minutes	



Glühbirne nicht enthalten /  
Light bulb not included



colour

**LANT-ROMA/L1 BCO**

8031436951248  
FANEU00005647



**LANT-PALETTO**

8031414042203  
FANEU00005624



1 x E27 MAX 60W



colour

**LANT-ROMA/P1 BCO**

8031436941249  
FANEU00005649



**LANT-ROMA/P1**

8031430771170  
FANEU00005648



1 x E27 MAX 60W



colour

**LANT-ROMA/P3**

8031430781179  
FANEU00005650



3 x E27 MAX 60W



colour

**LANT-ROMA-HEAD21**

8031414878512  
FANEU00005640



1 x E27 MAX 60W

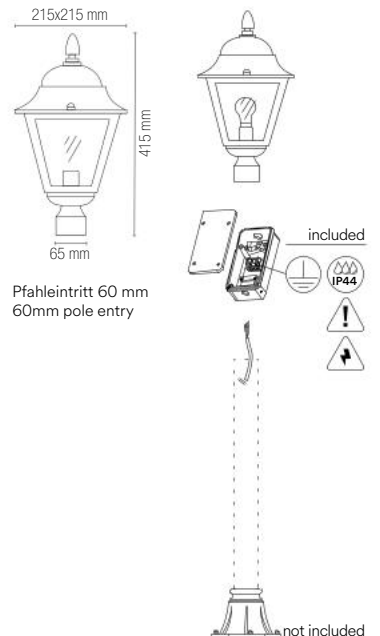
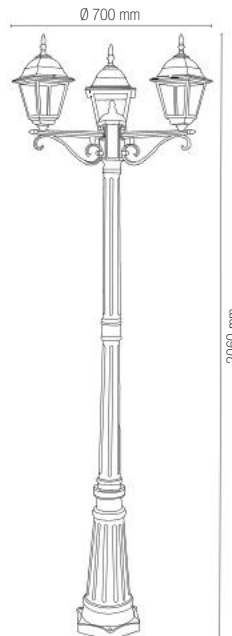
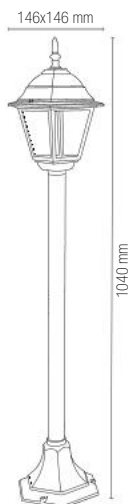





In.tec light KOMBINIERTE WAND-, HÄNGE- UND BODENLEUCHTEN / WALL, SUSPENSION AND FLOOR LAMPS COMBINED

# MILANO

Eine erlesene Kollektion von Laternen aus Aluminiumdruckguss mit Diffusor aus transparentem Glas. Die Verwendung wird in Außenumgebungen von Beherbergungsbetrieben oder in besonders gepflegten städtischen Umgebungen empfohlen.

A sophisticated collection of lanterns in die-cast aluminium with transparent glass diffuser. This product is recommended for outdoor use in hospitality settings or for particularly elegant urban areas.



	colour
<b>LANT-MILANO/APIA BCO</b> 8031436931240 FANEU00005590	●
<b>LANT-MILANO/APIA</b> 8031436921241 FANEU00005589	●

1 x E27 MAX 60W

	colour
<b>LANT-MILANO/APIB BCO</b> 8031436911242 FANEU00005592	●
<b>LANT-MILANO/APIB</b> 8031436901243 FANEU00005591	●

1 x E27 MAX 60W



Glühbirne nicht enthalten /  
Light bulb not included



**LANT-MILANO/S1 BCO**

8031436851234  
FANEU00005598



**LANT-MILANO/S1**

8031436841235  
FANEU00005597



1 x E27 MAX 60W

**LANT-MILANO/L1 BCO**

8031436891247  
FANEU00005594



**LANT-MILANO/L1**

8031436881248  
FANEU00005593



1 x E27 MAX 60W

**LANT-MILANO/P1 BCO**

8031436871232  
FANEU00005596



**LANT-MILANO/P1**

8031436971246  
FANEU00005595



1 x E27 MAX 60W

**LANT-MILANO-HEAD23**

8031414878529  
FANEU00005585



1 x E27 MAX 60W

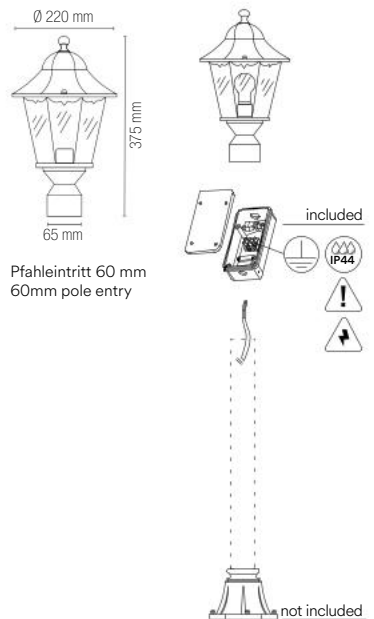
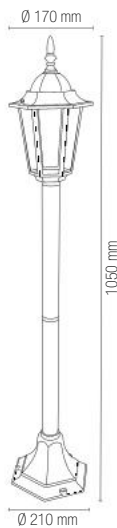

# FIRENZE

Eine umfassende Kollektion von Laternen, die sich durch extrem hochwertige Details auszeichnet. Das Gehäuse besteht aus schwarzem Aluminiumdruckguss mit silbernem Anstrich mit Diffusor aus transparentem Glas.

A complete collection of lanterns featuring highly prestigious details. Black die-cast aluminium fixture with brushed silver finish and transparent glass diffuser.

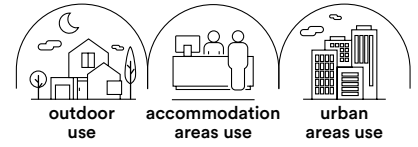

colour

**LANT-FIRENZE/AP1A**  
8031430701177  
FANEU00005556



1 x E27 MAX 60W

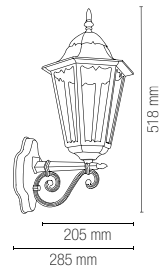

Glühbirne nicht enthalten /  
Light bulb not included



colour

**LANT-FIRENZE/AP1B**  
8031430711176  
FANEU00005557



1 x E27 MAX 60W



colour

**LANT-FIRENZE/S1**  
8031430741173  
FANEU00005560



1 x E27 MAX 60W



colour

**LANT-FIRENZE/P1**  
8031430721175  
FANEU00005558



1 x E27 MAX 60W



colour

**LANT-FIRENZE/P3**  
8031430731174  
FANEU00005559



3 x E27 MAX 60W

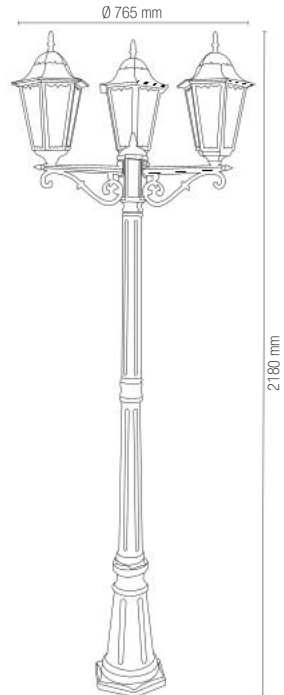
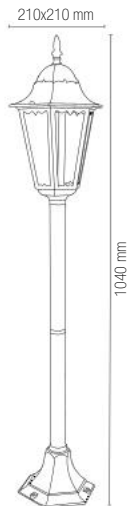

# SANTIAGO

Die Laterne besteht aus schwarzem Aluminiumdruckguss mit grünem Anstrich und Diffusor aus transparentem Glas. Die in den Einzelheiten sehr gepflegte Kollektion findet ihren richtigen Platz in eleganten Umgebungen von Beherbergungsbetrieben oder Stadtteilen.

Lanterns in black die-cast aluminium with brushed green finish and transparent glass diffuser. With great attention to detail, this collection is ideal for sophisticated hospitality facilities or urban spaces.



colour

**LANT-SANTIAGO/APIA**

8031430801174

FANEU00005656



1 x E27 MAX 60W

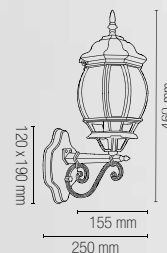

Glühbirne nicht enthalten /  
Light bulb not included



colour

**LANT-SANTIAGO/AP1B**  
8031430811173  
FANEU00005657



1 x E27 MAX 60W



colour

**LANT-SANTIAGO/S1**  
8031430841170  
FANEU00005660



1 x E27 MAX 60W



colour

**LANT-SANTIAGO/P1**  
8031430821172  
FANEU00005658



1 x E27 MAX 60W



colour

**LANT-SANTIAGO/P3**  
8031430831171  
FANEU00005659



3 x E27 MAX 60W

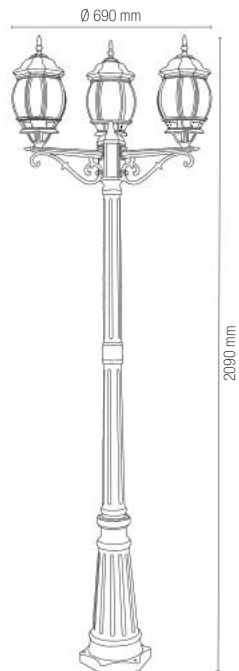

# VENEZIA

Laterne aus Aluminiumdruckguss mit kupferfarbenen Finishs und Diffusor aus transparentem Polycarbonat. Ein Anklang ewiger Schönheit für eine technische Beleuchtung, die nicht auf Stil und Originalität verzichtet.

Lanterns in die-cast aluminium with copper finish and transparent polycarbonate diffuser. A touch of timeless beauty for technical lighting that does not compromise on style and originality.

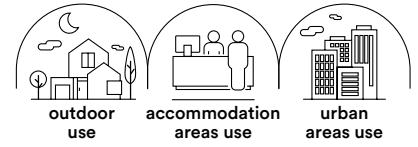

colour

**LANT-VENEZIA-AP1A**  
8031440312004  
FANEU00005661



1 x E27 MAX 60W

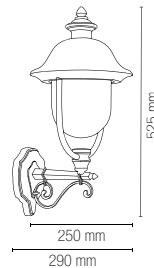

colour

**LANT-VENEZIA-AP1B**  
8031440311991  
FANEU00005662



1 x E27 MAX 60W

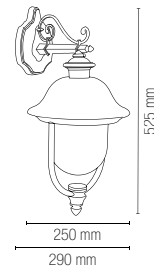

Glühbirne nicht enthalten /  
Light bulb not included



colour

**LANT-VENEZIA-S1**  
8031440313285  
FANEU00005667



1 x E27 MAX 60W



colour

**LANT-VENEZIA-L1**  
8031440311984  
FANEU00005664



1 x E27 MAX 60W



colour

**LANT-VENEZIA-P1**  
8031440313308  
FANEU00005665



1 x E27 MAX 60W



colour

**LANT-VENEZIA-P3**  
8031440313292  
FANEU00005666



3 x E27 MAX 60W

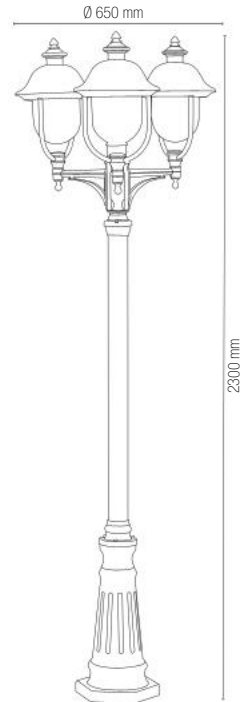
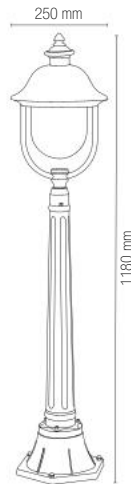
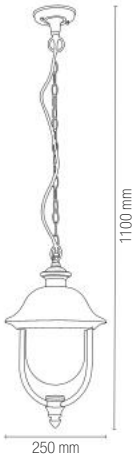

# PAVIA





Eine vielseitige Kollektion von zeitgemäßen Laternen, die als Wandleuchte, Wand- bzw. Hängelampe, Bodenleuchte und Laterne erhältlich ist. Das Gehäuse besteht aus schwarzem, geprägtem Aluminiumdruckguss mit Diffusor aus transparentem Acryl.

A versatile collection of contemporary lanterns, available in the following versions: wall lamp, wall light, pendant light, bollard light and street lamp. Black die-cast aluminium fixture with black embossed finish and transparent acrylic diffuser.



colour

**LANT-PAVIA-API**  
8031440312028  
FANEU00005625



1 x E27 MAX 60W



colour

**LANT-PAVIA-S1**  
8031440312042  
FANEU00005626



1 x E27 MAX 60W



colour

**LANT-PAVIA-P1**  
8031440312035  
FANEU00005626



1 x E27 MAX 60W



colour

**LANT-PAVIA-P3**  
8031440312011  
FANEU00005627



3 x E27 MAX 60W

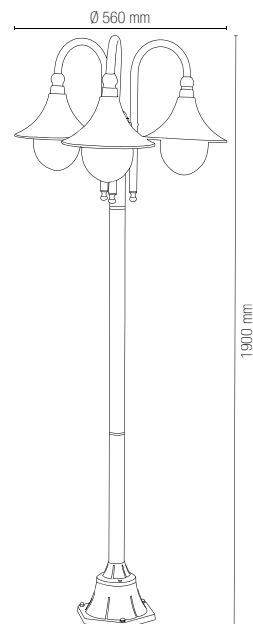
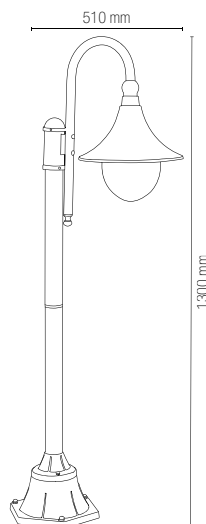
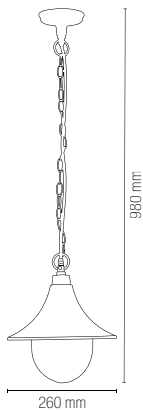
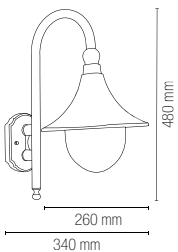

Glühbirne nicht enthalten /  
Light bulb not included

# BRIGHTMAX





**LED-Modul für Laternen mit Netzteil OSRAM OT60 DALI und virtueller Mitternacht. Ideal für größte Energieeinsparung und mit einem unabhängigen System zur Verringerung des Lichts während der Nachtstunden ausgestattet.**

LED module for street lamps with OSRAM OT60 DALI power supply and virtual midnight system. Ideal for maximum energy saving, it is fitted with an autonomous system for reducing light output at night.

**Material**

Aluminium

**Farbe**

Schwarz



**Farbtemperatur**

2700K / 4000K



**Driver**

inklusive



**Durata e on/off**

50.000h  
>25.000 on/off

**Material**

aluminum

**Colour**

black



**Colour temperature**

2700K / 4000K



**Driver**

included



**Life time and on/off**

50.000h  
>25.000 on/off

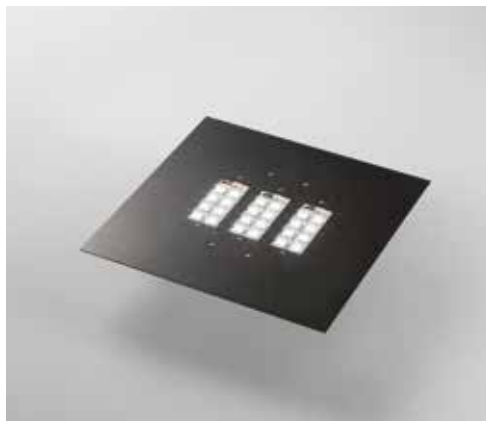

**BRIGHTMAX-60C**

8031414883899

FANEU00000472

lumen

colour temp.



colour



9600 lm

**BRIGHTMAX-60M**

8031414883905

FANEU00000473

lumen



9600 lm

watt

60W

beam angle

360°

**Photometrie des Produkts / Photometric curve**

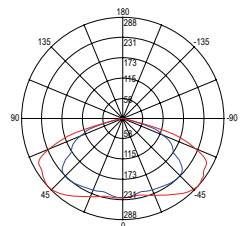

beam angle 360°

**BRIGHTMAX-LENS**

8031414883912

FANEU00000474

Doppelt und dreifach asymmetrische Linse / Be-asymmetric and three-asymmetric lens

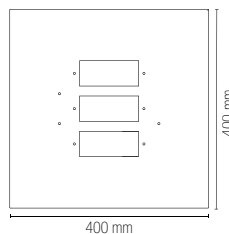

Die Platte kann bis zu einer Größe von 220x220 mm zugeschnitten werden / The plate can be cut up to a size of 220x220mm

**Photometrie des Produkts / Photometric curve**

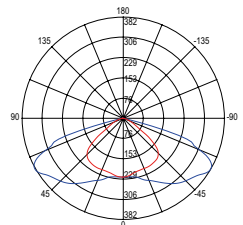

beam angle be-asymmetric

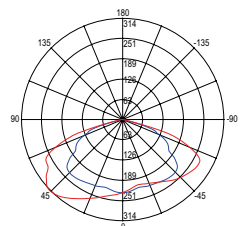

beam angle three-asymmetric

**Virtuelle Mitternacht / Minuit Virtuel**

Unabhängiges System zur Lichtreduzierung in 5 SCHRITTEN. Das LED-Modul ist nach einem bestimmten Programm konfiguriert (auf Wunsch individuell anpassbar), um die Energieeinsparung während der Nachtstunden zu optimieren. Das Gerät sieht ein Einlernsystem vor, das abhängig von den vorangegangenen Ein- und Ausschaltungen den Zeitpunkt der virtuellen Mitternacht eigenständig bestimmt. Die virtuelle Mitternacht ist der Zeitpunkt, der die Verringerung des Lichtstroms abhängig vom eingegebenen Profil bestimmt und die Anlage nicht beeinflusst. Für eine korrekte Funktionsweise des Systems der Virtuellen Mitternacht ist ein regelmäßiges tägliches Ein- und Ausschalten erforderlich.

Independent system of light reduction in 5 steps. The LED module is set with a specific program (customizable) to optimize the energy saving time during night hours. The device is equipped with a auto-feedback system which determine independently, the Virtual Midnight point based on the past switch on-switch-off time record. Virtual Midnight is the point which determines the light flux reduction based on the set profile, keeping the electrical system untouched. For a correct working of the system of Virtual Midnight it is necessary a daily regular cycle of switching on-off.

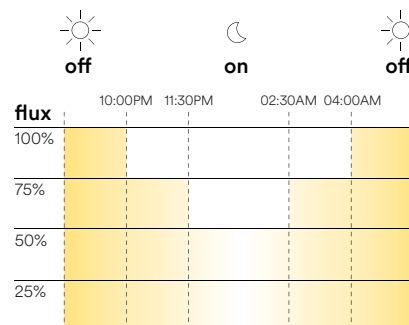

**Werkseitige Einstellungen / Default Settings**

hours	flux
ON ÷ 10:00	100%
10:00 ÷ 11:30	75%
11:30 ÷ 02:30	50%
02:30 ÷ 04:00	75%
04:00 ÷ OFF	100%

# POLLY

**Kollektion mit Basis aus Kunststofffaser und Kugeln aus Acrylglas in den Farben Durchsichtig, Weiß oder Rauchfarben. In verschiedenen Kombinationen erhältlich, garantiert Vielseitigkeit und ein perfektes Einfügen in sämtliche Umgebungen.,**

A collection with a plastic fibre base and PMMA spheres with a transparent, white or tinted finish. Available in a variety of combinations, it ensures versatility and perfect integration into any space.



POLLY



In.tec light KOMBINIERTE WAND-, HÄNGE- UND BODENLEUCHTEN / WALL-, SUSPENSION AND FLOOR LAMPS COMBINED

# POLLY



**I-POLLY-G20-TR180**  
8031414921973  
FANEU00003173

colour



1 x E27 MAX 20W

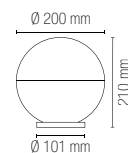

**I-POLLY-G25-TR180**  
8031414921980  
FANEU00003177

colour



1 x E27 MAX 20W

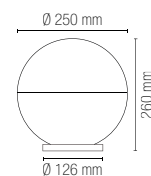

**I-POLLY-G30-TR180**  
8031414921997  
FANEU00003181

colour



1 x E27 MAX 20W

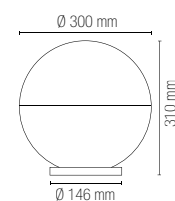

Glühbirne nicht enthalten /  
Light bulb not included

Die Kugeln POLLY G20-G25-G30 können ausschließlich unter Verwendung  
der auf S. 226-229 aufgeführten Zubehörteile montiert werden /  
The POLLY G20-G25-G30 spheres can only be mounted  
using the accessories listed on pages 226-229

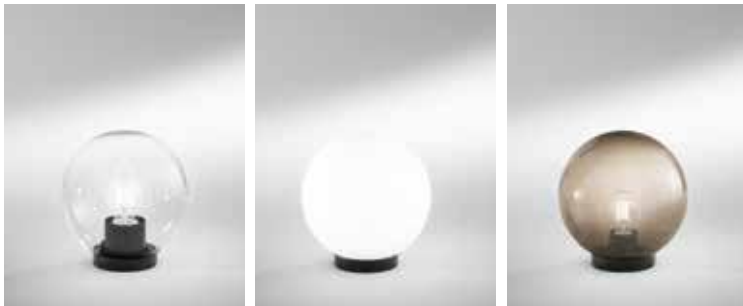

	colour
<b>I-POLLY-G20-TR</b> 8031414889136 FANEU00003172	
<b>I-POLLY-G20-BCO</b> 8031414889112 FANEU00003170	
<b>I-POLLY-G20-GR</b> 8031414889129 FANEU00003171	

1 x E27 MAX 20W

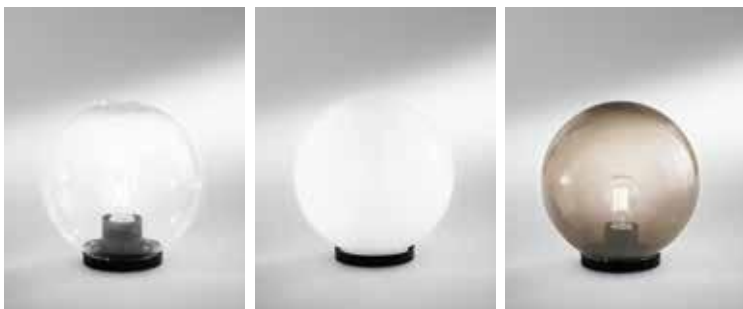
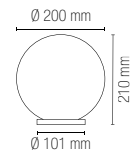

	colour
<b>I-POLLY-G25-TR</b> 8031414889167 FANEU00003176	
<b>I-POLLY-G25-BCO</b> 8031414889143 FANEU00003174	
<b>I-POLLY-G25-GR</b> 8031414889150 FANEU00003175	

1 x E27 MAX 20W

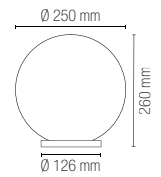

	colour
<b>I-POLLY-G30-TR</b> 8031414889198 FANEU00003180	
<b>I-POLLY-G30-BCO</b> 8031414889174 FANEU00003178	
<b>I-POLLY-G30-GR</b> 8031414889181 FANEU00003179	

1 x E27 MAX 20W

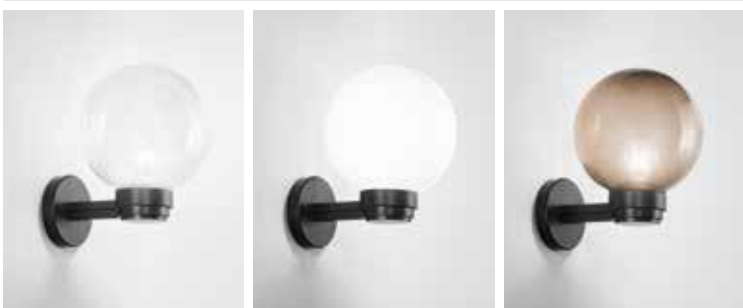
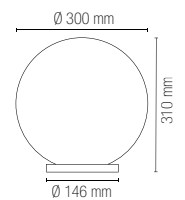

	colour
<b>I-POLLY-AP-TR</b> 8031414889105 FANEU00003167	
<b>I-POLLY-AP-BCO</b> 8031414889389 FANEU00003165	
<b>I-POLLY-AP-GR</b> 8031414889099 FANEU00003166	

1 x E27 MAX 20W

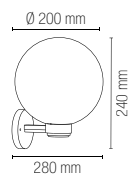

# POLLY





**I-POLLY-PD**  
8031414921942  
FANEU00003183

Zubehör für Aufhängung mit Gummikabel und Verbinder / Suspension accessory with rubber cable

colour



**I-POLLY-SPK**  
8031414921959  
FANEU00003189

Zubehör zur Befestigung mit Pflock mit Verbinder und Kabelhalter / Accessory for peg fixing with connector and cable holder

colour

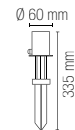

**I-POLLY-SPK-S**  
8031414921966  
FANEU00003190

Zubehör zur Befestigung mit Pflock mit Gummikabel und Schuko stecker / Accessory for peg fixing with rubber cable and Schuko socket

colour

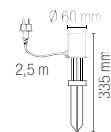

**Enthaltenes Zubehör / Accessories included**

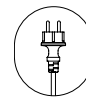

2,5 m Kabel mit Schuko stecker / 2,5 m of cabl with schuko plug

**IP44**

# POLLY





**I-POLLY-TUBE100**

8031414890149  
FANEU00003191

colour



**I-POLLY-TUBE150**

8031414890156  
FANEU00003192



**I-POLLY-TUBE200**

8031414890163  
FANEU00003193

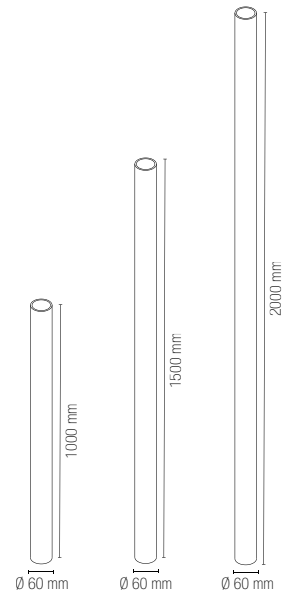

**I-POLLY-BASE**  
8031414889235  
FANEU00003168

colour



**I-POLLY-JOINT**  
8031414890170  
FANEU00003182

colour



**I-POLLY-BASE-AP**  
8031414904587  
FANEU00003169

colour

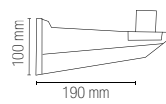
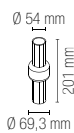
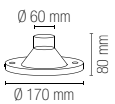

# GECO DJ

LED-Handlampe RGBW aus Polyethylen mit integriertem Bluetooth-Lautsprecher. Ein Konzentrat an Technologie mit überraschenden Farbeffekten und Steuerung der Musik über Smartphone oder IR-Fernbedienung.

Portable RGBW LED lamp in polyethylene with Bluetooth speaker. A technological marvel with stunning colour effects and music control via smartphone or IR remote control.



**Material**  
PE

**Farbtemperatur**  
RGB + 4000K



**Driver**  
inklusive

**Material**  
PE

**Colour temperature**  
RGB + 4000K



**Driver**  
included



	colour temp.
<b>I-GECO-DJ-L25</b> 8031414862542 FANEU00002026 lumen	 RGB + 180 lm - 8h
watt	3W

## Enthaltenes Zubehör / Accessories included



Ladekabel mit Adapter DC5 V 1 A 1,2 m /  
Charging cable with adaptor  
DC5V 1A 1,2 m 230V 50Hz

IP20



Infrarot-Fernbedienung /  
IR remote control



Speaker 10 W Bluetooth 4.0,  
Anschlussabstand max. 15 m, Dauer 2h /  
10w speaker bluetooth 4.0 connection  
distance max 15 m, lasting time 2h



Aufladbare Batterie, nicht ersetzbar /  
Rechargeable battery not replaceable

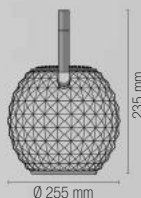



In.tec light KOMBINIERTE WAND-, HÄNGE- UND BODENLEUCHTEN / WALL, SUSPENSION AND FLOOR LAMPS COMBINED

# GECO LED

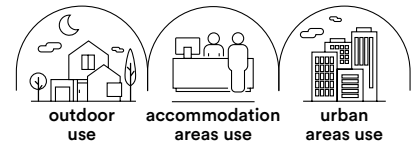

Eine Kollektion, die Vase und LED-Lampen RGBW aus Polyethylen umfasst, in Kugel- oder Würfelform. Die ganze Funktionalität der LED für die gewünschte Farbeinstellung. Ideal für Innen- und Außenbereiche.

A collection including a vase and RGBW LED lamps in polyethylene, in spherical or cubic shapes. All LED functions for adjusting to the required colour. Ideal for outdoor and indoor spaces.

**Material**

PE

**Farbtemperatur**

RGB + 4000K



**Driver**

inklusive

**Material**

PE

**Colour temperature**

RGB + 4000K



**Driver**

included



**Enthaltenes Zubehör / Accessories included**



Infrarot-Fernbedienung / IR remote control



Aufladbare Batterie, nicht ersetzbar / Rechargeable battery non replaceable

	colour temp.	
<b>I-GECO-VASO-Q-L</b>		
8031414862535		
FANEU00002043		
lumen	RGB	240 lm - 8h
<b>I-GECO-VASO-Q-XL</b>		
8031414864713		
FANEU00002044		
lumen	RGB	240 lm - 8h
watt		4W

	colour temp.	
<b>I-GECO-VASO-R-L</b>		
8031414862528		
FANEU00002045		
lumen	RGB	240 lm - 8h
<b>I-GECO-VASO-R-XL</b>		
8031414864720		
FANEU00002046		
lumen	RGB	240 lm - 8h
watt		4W

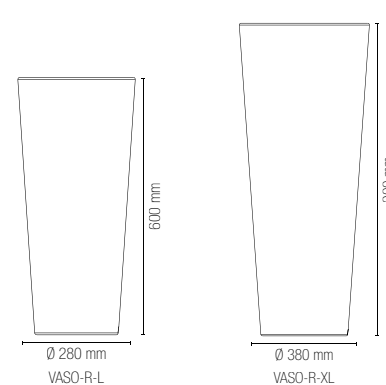
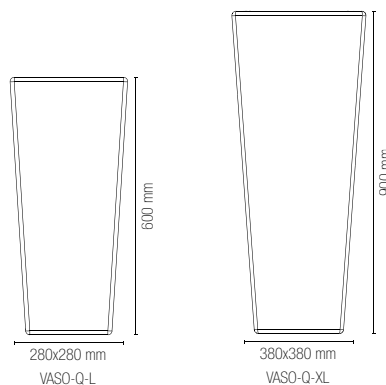



	colour temp.
<b>I-GECO-SFERA-L30</b> 8031414862436 FANEU00002030 lumen	+ RGB 240 lm - 8h
<b>I-GECO-SFERA-L40</b> 8031414862443 FANEU00002031 lumen	+ RGB 240 lm - 8h
<b>I-GECO-SFERA-L50</b> 8031414862450 FANEU00002032 lumen	+ RGB 240 lm - 8h
watt	4W

	colour temp.
<b>I-GECO-CUBO-L30</b> 8031414862467 FANEU00002021 lumen	+ RGB 240 lm - 8h
<b>I-GECO-CUBO-L40</b> 8031414862474 FANEU00002022 lumen	+ RGB 240 lm - 8h
<b>I-GECO-CUBO-L50</b> 8031414862481 FANEU00002023 lumen	+ RGB 240 lm - 8h
watt	4W

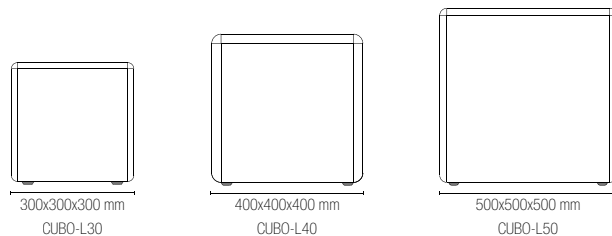
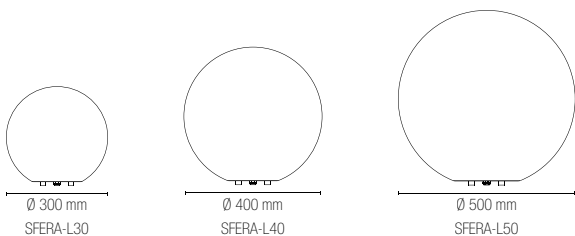

# GECO E27





**Umfassende Lampenkollektion mit E27-Sockel aus Polyethylen und hohem Schutz vor Staub und Flüssigkeiten. Mit mittels IR-System einstellbarer Steuerung der Beleuchtung von mehrfarbig bis zu dynamischem Weiß.**

An extensive collection of lamps with E27 socket in polyethylene and high protection against dust and liquids. With multicolour and dynamic white lighting control, adjustable via an IR system.



Glühbirne nicht enthalten /  
Light bulb not included



**I-GECO-SFERA-S30**

8031414864461  
FANEU00002034

1 x E27 MAX 42W

**I-GECO-SFERA-S40**

8031414864454  
FANEU00002035

1 x E27 MAX 42W

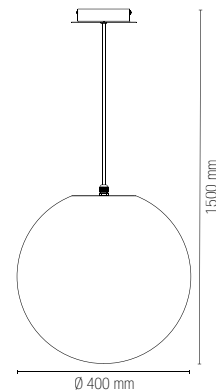
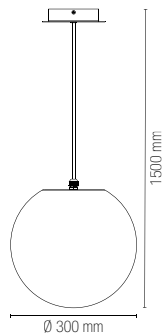



**I-GECO-VASO-E-Q-L**

8031414868506  
FANEU00002039

**I-GECO-VASO-E-Q-XL**

8031414868131  
FANEU00002040

1 x E27 MAX 42W



**I-GECO-VASO-E-R-L**

8031414868513  
FANEU00002041

**I-GECO-VASO-E-R-XL**

8031414868520  
FANEU00002042

1 x E27 MAX 42W

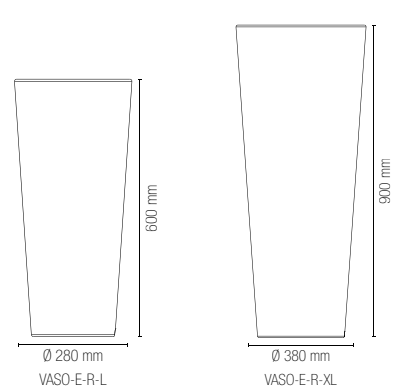
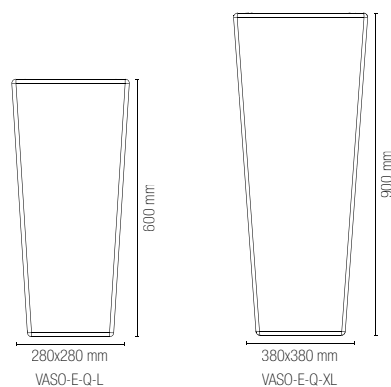

Glühbirne nicht enthalten /  
Light bulb not included



**I-GECO-SFERA-E-L30**

8031414868476  
FANEU00002027

**I-GECO-SFERA-E-L40**

8031414868483  
FANEU00002028

**I-GECO-SFERA-E-L50**

8031414868490  
FANEU00002029

1 x E27 MAX 42W

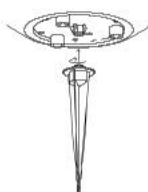

**I-GECO-SPK**

8031414878437  
FANEU00002038

Aluminiumpflock  
für Lampen Reihe  
GECO E27 /  
Aluminum spike for  
E27 GECO family

**I-GECO-CUBO-E-L30**

8031414867943  
FANEU00002018

**I-GECO-CUBO-E-L40**

8031414868117  
FANEU00002019

**I-GECO-CUBO-E-L50**

8031414868124  
FANEU00002020

1 x E27 MAX 42W

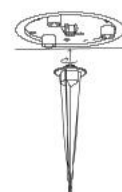

**I-GECO-SPK**

8031414878437  
FANEU00002038

Aluminiumpflock  
für Lampen  
Reihe GECO E27 /  
Aluminum spike for  
E27 GECO family

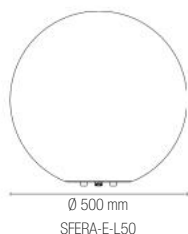
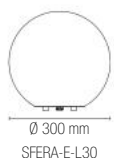

# GECO E27

Stehlampe aus Polyethylen mit Struktur aus mattweißem oder anthrazitfarbenem Metall.

PE floor lamp with metal structure white or anthracite colour.

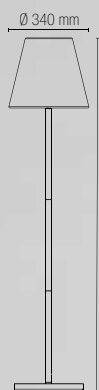

**I-GECO-BAR-PT**  
8031414868599  
FANEU00002013

colour



1 x E27 MAX 42W

**Enthaltenes Zubehör /  
Accessories included**



2,5 m Kabel mit  
Schukostecker /  
2,5 m of cable  
with schuko plug

  
IP44



Glühbirne nicht enthalten /  
Light bulb not included



In.tec light KOMBINIERTE WAND-, HÄNGE- UND BODENLEUCHTEN / WALL-, SUSPENSION AND FLOOR LAMPS COMBINED

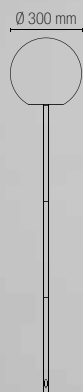

**I-GECO-SFERA-PT30**  
8031414864430  
FANEU00002033

colour



1 x E27 MAX 42W

**Enthaltenes Zubehör / Accessories included**



2,5 m Kabel mit Schukostecker / 2,5 m of cable with schuko plug



Glühbirne nicht enthalten / Light bulb not included

# GECO LED SOLAR





**Tragbare und schwimmende LED-Leuchte RGBW aus Polyethylen mit automatischer Solarladung. Eine originelle Lösung für Außenumgebungen mit komplettem Schutz vor Staub und hervorragender Beständigkeit gegen Spritzer.**

Portable and floating RGBW LED lamp in polyethylene with solar self-charging. An original solution for outdoor spaces, with full protection against dust and optimum protection against splashes.

**Material**  
PE

**Farbtemperatur**  
RGB + 4000K



**Driver**  
inklusive

**Material**  
PE

**Colour temperature**  
RGB + 4000K



**Driver**  
included



**Enthaltenes Zubehör / Accessories included**



Infrarot-Fernbedienung / IR remote control



**Netzteilladung / DC charge**  
Aufladbare Batterie, nicht ersetzbar / Rechargeable battery not replaceable



**Solarladung / Auto solar charge**  
Aufladbare Batterie, nicht ersetzbar / Rechargeable battery not replaceable

	colour temp.		colour temp.
<b>I-GECO-SFERA-SOL30</b> 8031414870868 FANEU00002036 lumen	+	RGB 90 lm - 12h	
<b>I-GECO-SFERA-SOL40</b> 8031414870875 FANEU00002037 lumen	+	RGB 90 lm - 12h	
		watt	1,5W
<b>I-GECO-CUBO-SOL30</b> 8031414870837 FANEU00002024 lumen	+	RGB 90 lm - 12h	
<b>I-GECO-CUBO-SOL40</b> 8031414870844 FANEU00002025 lumen	+	RGB 90 lm - 12h	
		watt	1,5W

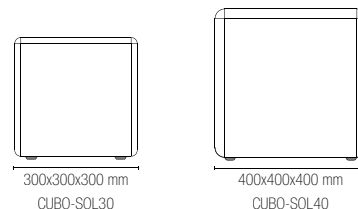
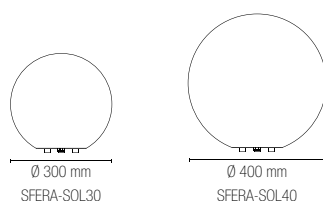

# PICNIC COLOR



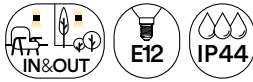

**Elektrische Lichterkette E12 für Außenbereiche mit PVC-Kabel, Schukostecker und modulierbarem Verbinder, der einen leichteren "End-to-End"-Anschluss garantiert. Ideal für Innen- oder Außenbereiche.**

E12 light string with PVC cable for outdoor use, Schuko plug and modular connector that ensures easy end-to-end connection. Ideal for indoor and outdoor spaces.



colour

Enthaltenes Zubehör /  
Accessories included

**I-PICNIC-COLOR**

8031414891863  
FANEU00003090



25 x E12



**Glühbirne E12  
E12 light bulb**

7 rot/red  
6 gelb/yellow  
6 grün/green  
6 blau/blue

watt 0,3W  
volt 230V

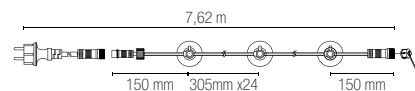

**END-TO-END**

easy connection / max 1000W



# PICNIC

**Elektrische Lichterkette E12 für Außenbereiche mit PVC-Kabel, Schukostecker und modulierbarem Verbinder. Für Innen- oder Außenbereiche, mit Schutz vor Staub und Flüssigkeiten.**

**Auch in der Version mit Solarpanel zum Aufladen.**

E12 light string with PVC cable for outdoor use, Schuko plug and modular connector. For outdoor and indoor spaces, with protection against dust and liquids. Also available in a version with solar charging panel.

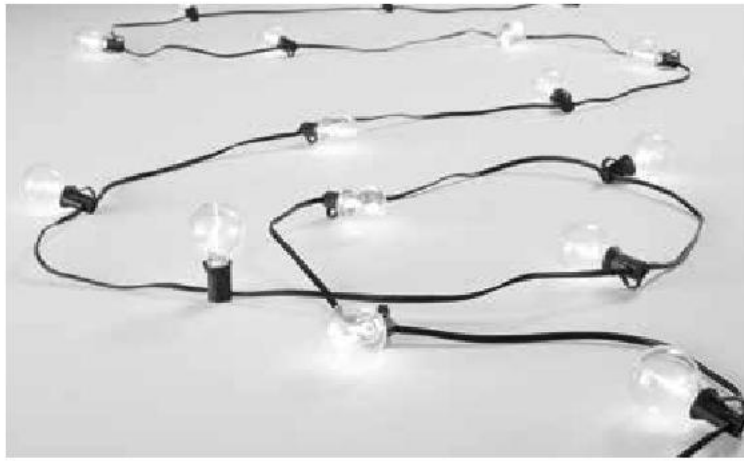

<p>colour <span style="display: inline-block; width: 10px; height: 10px; background-color: black; border-radius: 50%;"></span></p> <p><b>I-PICNIC-LED</b> 8031414884407 FANEU00003097</p> <hr/> <p>25 x E12</p>	<p>Enthaltenes Zubehör / Accessories included</p> <div style="display: flex; align-items: center;"> <p><b>Glühbirne E12 E12 light bulb</b></p> </div> <table border="0" style="width: 100%;"> <tr> <td>watt</td> <td style="text-align: right;">0,3W</td> </tr> <tr> <td>volt</td> <td style="text-align: right;">230V</td> </tr> </table> <p>3000K <span style="display: inline-block; width: 10px; height: 10px; background-color: yellow; border-radius: 50%; margin-left: 20px;"></span></p>	watt	0,3W	volt	230V
watt	0,3W				
volt	230V				

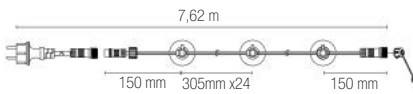

## END-TO-END

easy connection / max 1000W

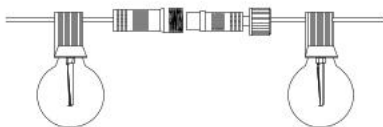

<p>colour <span style="display: inline-block; width: 10px; height: 10px; background-color: black; border-radius: 50%;"></span></p> <p><b>I-PICNIC-SOLAR</b> 8031414884414 FANEU00003101</p> <hr/> <p>25 x E12</p>	<p>Enthaltenes Zubehör / Accessories included</p> <div style="display: flex; align-items: center;"> <p><b>Glühbirne E12 E12 light bulb</b></p> </div> <table border="0" style="width: 100%;"> <tr> <td>watt</td> <td style="text-align: right;">0,3W</td> </tr> <tr> <td>volt</td> <td style="text-align: right;">3V</td> </tr> </table> <p>3000K <span style="display: inline-block; width: 10px; height: 10px; background-color: yellow; border-radius: 50%; margin-left: 20px;"></span></p>	watt	0,3W	volt	3V
watt	0,3W				
volt	3V				



**3.7V 2200mAh**  
Aufladbare Batterie,  
nicht ersetzbar /  
Rechargeable battery  
not replaceable



**Elektrische Lichterkette E14 oder E27 für Außenbereiche mit Kabel aus Gummi, inklusive Schukostecker und modulierbarem Verbinder.**  
 Light string E14 or E27 for outdoor rubber cable inclusive of schukoplug and modular connector.



colour

**I-PICNIC-E27-BCO**

8031414043064  
 FANEU00003094



**I-PICNIC-E27**

8031414862719  
 FANEU00003093



Glühbirne nicht enthalten /  
 Light bulb not included

10 x E27 MAX 25W

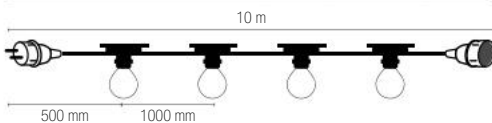

**END-TO-END**

easy connection / max 1000W

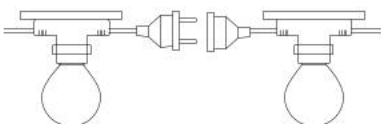

colour

**I-PICNIC-E14-BCO**

8031414023745  
 FANEU00003092



**I-PICNIC-E14**

8031414862726  
 FANEU00003091



Glühbirne nicht enthalten /  
 Light bulb not included

10 x E14 MAX 25W

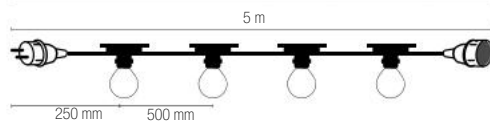

**END-TO-END**

easy connection / max 1000W

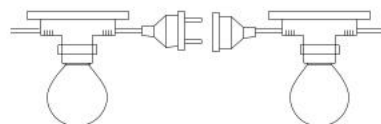

# PICNIC INT





**Elektrische LED-Lichterkette für Außenbereiche mit PVC-Kabel, Schukostecker und modulierbarem Verbinder. Mit modernem System zur smarten Steuerung über zahlreiche Geräte und RGB- und CCT-Farbeinstellung.**

LED light string with PVC cable for outdoor use, including a Schuko plug and modular connector. Cutting-edge system for smart control from multiple devices and RGB colour and CCT adjustment.

**Material**  
PC + PVC

**Farbe**  
Schwarz



**Farbtemperatur**  
RGB + CCT



**Driver**  
eingebaut

**Material**  
PC + PVC

**Colour**  
black



**Colour temperature**  
RGB + CCT



**Driver**  
built-in



**I-PICNIC-INT**  
8031414884391  
FANEU00003096  
lumen

colour temp.



colour



400 lm

watt	10 x 0,5W
beam angle	110°

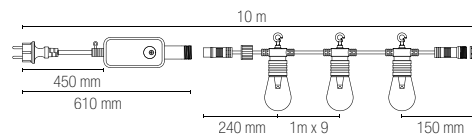

**END-TO-END**

easy connection / max 1000W

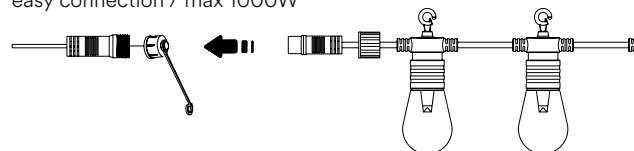

Control system easy installation



# PICNIC RGB



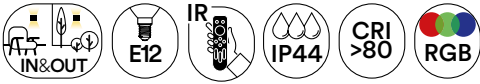

**LED-Lichterkette für Außenbereiche mit PVC-Kabel, inklusive Schukostecker und modulierbarem Verbinder. Mit RGB-Farbsteuerung mittels Fernbedienung, hoher Farbwiedergabe und Schutz vor Wasser und Staub.**

LED light string with PVC cable for outdoor use, including a Schuko plug and modular connector. With remote control of RGB colours, high colour rendering and protection against water and dust.

**Material**  
PC + PVC

**Farbe**  
Schwarz



**Farbtemperatur**  
RGB



**Driver**  
eingebaut

**Material**  
PC + PVC

**Colour**  
black



**Colour temperature**  
RGB



**Driver**  
built-in



**I-PICNIC-LED-RGB**  
8031414921911  
FANEU00003099

colour temp.



RGB

colour



watt

5W

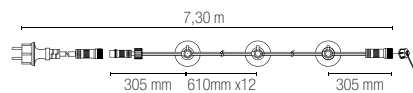

**END-TO-END**

easy connection / max 2 wires with a single adapter

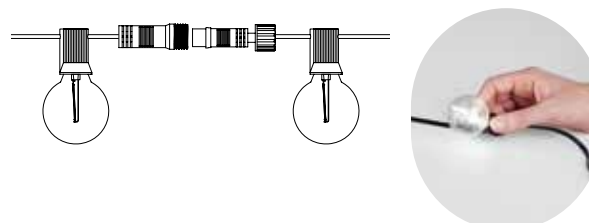





**Aufladbare Tischleuchten / Rechargeable table lamps**  
outdoor

# COCKTAIL

Eine erlesene Kollektion von aufladbaren Tischlampen. Gehäuse aus Metall mit geprägtem Finish und in verschiedenen Farbtönen erhältlich. Die Lichtstärke kann über eine bequeme Touch-Steuerung eingestellt werden.

A sophisticated collection of rechargeable table lamps. It features a metal fixture with embossed finish and is available in various colours. Brightness intensity is adjusted with convenient touch control.



## Material

Metall

## Farbe

Geprägt, Weiß  
Geprägt, Schwarz  
Geprägt, Gold  
Geprägt, Corten



## Farbtemperatur

3000K



## Material

métal

## Colour

embossed white  
embossed black  
embossed gold  
embossed corten



## Colour temperature

3000K



### LED-COCKTAIL-BCO

8031414882496  
FANEU00005977

lumen 192 lm - 9h

### LED-COCKTAIL-NER

8031414882502  
FANEU00005983

lumen 192 lm - 9h

### LED-COCKTAIL-ORO

8031414885282  
FANEU00005986

lumen 192 lm - 9h

### LED-COCKTAIL-BRO

8031414882519  
FANEU00005979

lumen 192 lm - 9h

watt 2,2W



## Enthaltenes Zubehör / Accessories included



Ladekabel /  
Charging cable



**DC3.7V 2x2200 mAh**  
Aufladbare Batterie, nicht ersetzbar /  
Rechargeable battery not replaceable





In.tec light AUFLADBARE TISCHLEUCHTEN / RECHARGEABLE TABLE LAMPS

# JIN

Kollektion bestehend aus LED-Tisch- und Stehlampe mit Solarpanel und Aufladung über Kabel. Minimalistisches, schickes Design, das durch die erlesenen Farbtöne (Schwarz, Grün und Weiß) und die verstellbare Lichtstärke zur Geltung kommt.

A collection including a LED table lamp and floor lamp provided with a solar panel and cable charging. Minimalist chic design enhanced with subtle colours – black, green and white – and adjustable brightness intensity.



JIN



In.tec light AUFLADBARE TISCHLEUCHTEN / RECHARGEABLE TABLE LAMPS

# JIN

Unvergängliche Tischlampe mit warmer LED-Beleuchtung mit Versorgung über Solarpanel für eine Dauer von bis zu 10 Stunden. Mit Einschaltsystem über Kabel und drei eleganten Finishes in Grün, Weiß oder Schwarz.

Iconic table lamp with warm LED lighting, powered by a solar panel for up to 10 hours of battery life. With cable ignition system and three elegant finishes: green, white or black.



**Material**  
Metall oder PE

**Farbe**  
Weiß  
Schwarz  
Grün



**Farbtemperatur**  
3000K



**Material**  
metal and PE

**Colour**  
white  
black  
green



**Colour temperature**  
3000K



	colour temp.	colour
<b>LED-JIN-L-BCO</b> 8031414931156 FANEU00024010 lumen		
<b>LED-JIN-L-NER</b> 8031414931149 FANEU00024011 lumen		
<b>LED-JIN-L-VDE</b> 8031414931163 FANEU00024012 lumen		
<b>watt</b>		1,2W

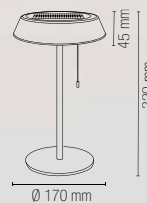

#### Enthaltenes Zubehör / Accessories included

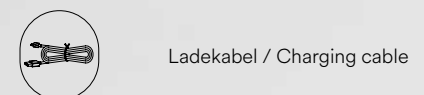
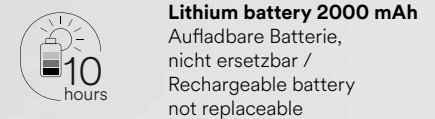
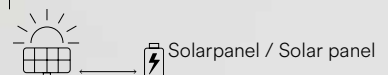



Elegante LED-Stehlampe für Außenbereiche mit Solarpanel und Aufladung über Kabel. Minimalistisches, schickes Design, das durch die erlesenen Farbtöne (Schwarz, Grün und Weiß) und die verstellbare Lichtstärke zur Geltung kommt.

Elegant LED floor lamp for outdoor use, provided with a solar panel and cable charging. Minimalist chic design enhanced with subtle colours – black, green and white – and adjustable brightness intensity.



In.tec light AUFLADBARE TISCHLEUCHTEN / RECHARGEABLE TABLE LAMPS

	colour temp.	colour
<b>LED-JIN-PT-BCO</b> 8031414931187 FANEU00024013 lumen	180 lm	
<b>LED-JIN-PT-NER</b> 8031414931170 FANEU00024014 lumen	180 lm	
<b>LED-JIN-PT-VDE</b> 8031414931194 FANEU00024015 lumen	180 lm	
<b>watt</b>		<b>3W</b>



**Enthaltenes Zubehör / Accessories included**

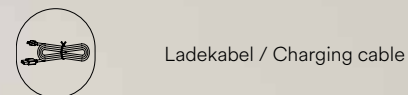
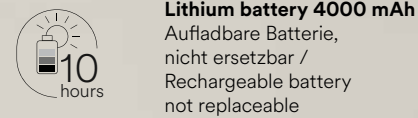

# ROBIN

Charakteristische kleine LED-Lampe aus Metall mit Solar- oder Kabelaufladung und langer Dauer. Tragbar und mit Touch-Schalter mit 3 Helligkeitsstufen ausgestattet. Wird in den Farben Grün, Schwarz und Weiß angeboten.

Distinctive metal LED lamp with solar or cable charging and extended battery life. Portable and fitted with a touch switch with 3 levels of brightness intensity. Available in green, black and white.



**Material**  
Metall oder PE

**Farbe**  
Weiß  
Schwarz  
Grün



**Farbtemperatur**  
3000K



**Material**  
metal and PE

**Colour**  
white  
black  
green



**Colour temperature**  
3000K



**LED-ROBIN-RCO**  
8031414931125  
FANEU00027038  
lumen

colour temp.	colour
84 lm	

**LED-ROBIN-NER**  
8031414931118  
FANEU00024016  
lumen

84 lm	

**LED-ROBIN-VER**  
8031414931132  
FANEU00024031  
lumen

84 lm	

watt 1,2W

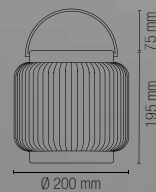

## Enthaltenes Zubehör / Accessories included

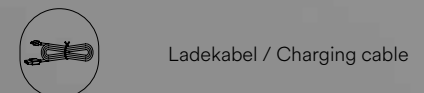
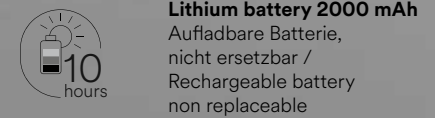
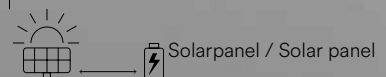

ROBIN



In.tec light AUFLADBARE TISCHLEUCHTEN / RECHARGEABLE TABLE LAMPS





**Einbau- und Orientierungsleuchten / Inground and walk lights**  
outdoor

# RIDER





**Satz Einbau-Orientierungsleuchten bestehend aus 6 Teilen. Die begehbaren Orientierungsleuchten garantieren einen optimalen IP-Schutzgrad gegen Staub und Flüssigkeiten und hohe Farbwiedergabe. Der Artikel kann auch mit RGB-Beleuchtung individuell gestaltet werden.**  
 Recessed step light kit comprising 6 pieces. Walkable, the step lights ensure an optimum level of IP protection against dust and liquids, and high colour rendering. The product can also be customised with RGB lighting.

**Material**  
Stahl

**Farbe**  
Stahl



**Farbtemperatur**  
RGB



**Driver**  
12V 6W  
inklusive

**Material**  
steel

**Colour**  
stainless steel



**Colour temperature**  
RGB



**Driver**  
12V 6W  
included



	colour temp.	colour
<b>LED-RIDER-R6</b>		
8031436141236		
FANEU00007273		
lumen	360 lm	
watt	6 x 0,6W	
driver	12V 6W DC	
beam angle	120°	
pressure loads	max 100 kg	
	Ø 23 mm	

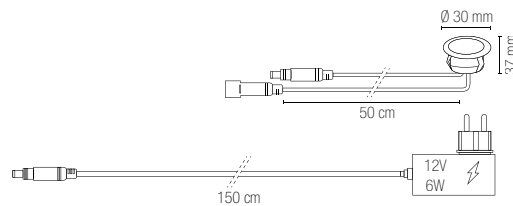

	colour temp.	colour
<b>LED-RIDER-R6-RGB</b>		
8031439871260		
FANEU00007278		
lumen	RGB	
watt	6 x 0,6W	
driver	12V 6W DC	
beam angle	120°	
pressure loads	max 100 kg	
	Ø 23 mm	

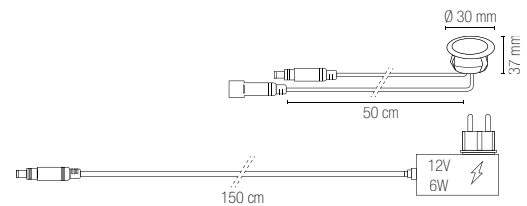

**Photometrie des Produkts / Photometric curve**

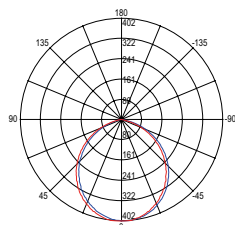

LED-RIDER-R6

**Enthaltenes Zubehör / Accessories included**



x6



x6

1,5 m Kabel / 1,5 m cable



IP44

**Enthaltenes Zubehör / Accessories included**



x6



x1

1,5 m Kabel / 1,5 m cable



IR Control system



IP44

# RIDER

Das elegante silberne Finish und das natürliche weiße Licht machen Rider ideal für die Verwendung in Beherbergungsbetrieben.

The elegant silver finish and natural white light make Rider ideal for installation at hospitality facilities.

**Material**  
Zinklegierung

**Farbe**  
Silber



**Farbtemperatur**  
4000K



**Driver**  
12V 6W DC  
inklusive

**Material**  
zinc alloy

**Colour**  
silver



**Colour temperature**  
4000K



**Driver**  
12V 6W DC  
included



colour temp. | colour

## LED-RIDER-R6-DIR

8031439921279  
FANEU00007275  
lumen

100 lm

watt	6 × 0,6W
driver	12V 6W DC
beam angle	105°
pressure loads	max 100 kg
	Ø 23 mm

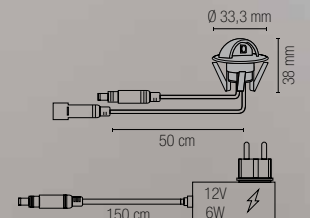

### Photometrie des Produkts / Photometric curve

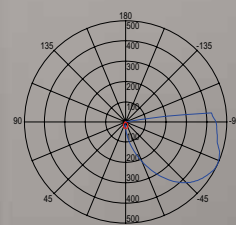

LED-RIDER-R6-DIR

### Enthaltenes Zubehör / Accessories included



x6



x1

1,5 m Kabel /  
1,5 m cable



IP44

# BARRET



Einbau-Orientierungsleuchte, erhältlich mit 2 Farbtemperaturen und hohem Farbwiedergabeindex. Bietet hervorragenden Schutz gegen Staub und Wasser, bis zum Eintauchen, und extreme Strapazierfähigkeit beim Begehen.

Recessed step light available in 2 colour temperatures with high colour rendering. It provides excellent protection against dust and water, even when submerged, and is extremely resistant to foot traffic.

**Material**

Aluminium

**Farbe**

Nickel



**Temperatura colore**

3000K / 4000K



**Driver**

350 mA 3,5 V  
Konstantstrom  
nicht enthalten

**Material**

aluminum

**Colour**

nikel



**Colour temperature**

3000K / 4000K



**Driver**

350mA 3,5V  
constant current  
not included

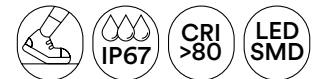

**LED-BARRET-R24C**

8031440355070  
FANEU00005848

lumen

colour temp.	colour
85 lm	

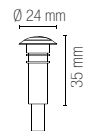
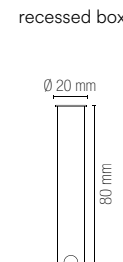

**LED-BARRET-R24**

8031440364416  
FANEU00005847

lumen

85 lm	

watt	1W
driver	3,5V DC
beam angle	40°
pressure loads	max 250 kg
	Ø 16 mm

**Photometrie des Produkts /  
Photometric curve**

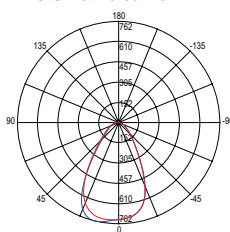

LED-BARRET-R24

**Serieller Anschluss /  
Serie connection system**

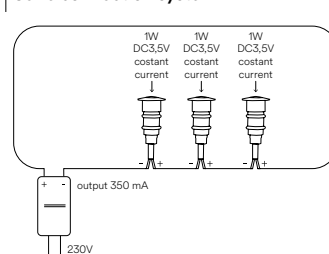

Driver ab S./from p. 414

**Enthaltenes Zubehör /  
Accessories included**



x1  
1 m Kabel / 1 m cable



# SUBWAY

Einbau-Orientierungsleuchte mit Beleuchtung mit warmem, neutralem oder blauem Licht. Aus Aluminium im Farbton Nickel, garantiert einen extrem hohen Schutzgrad in Bezug auf Staub, Flüssigkeiten und Stoßfestigkeit und eine Farbwiedergabe, die den Sehkomfort garantiert.

Recessed step light with warm, neutral or blue lighting. Made of aluminium with a nickel finish, it guarantees an extremely high level of protection against dust, liquids and impacts, with a colour rendering that ensures visual comfort.

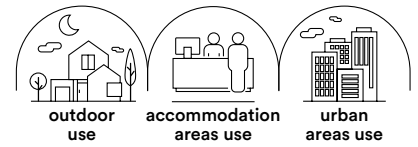

**Material**

Aluminium

**Farbe**

Nickel



**Farbtemperatur**

3000K / 4000K / BLUE



**Driver**

DC 12-24V

Konstantspannung nicht enthalten

**Material**

aluminium

**Colour**

nikel



**Colour temperature**

3000K / 4000K / BLUE



**Driver**

DC 12-24V

constant voltage not included



**LED-SUBWAY-R1C**

8031414879342

FANEU00007492

lumen

colour temp.

colour



385 lm

**LED-SUBWAY-R1M**

8031414877263

FANEU00007494

lumen



420 lm

**LED-SUBWAY-R1B**

8031414877270

FANEU00007491

lumen



53 lm

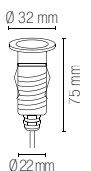

watt 3W

driver 12/24V

beam angle 15°

pressure loads max 1000 kg

Ø 24 mm

**Photometrie des Produkts / Photometric curve**

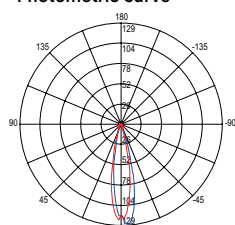

LED-SUBWAY-R1

**Parallelschaltung / Serie connection system**

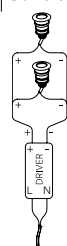

Driver ab S./from p. 414  
Controller ab S./from p. 430

Enthaltenes Zubehör /  
Accessories included



x1  
1 m Kabel / 1 m cable



# IMPACT

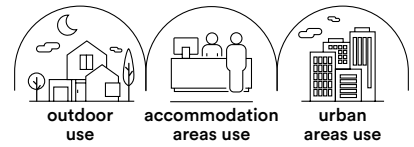

Einbau-Orientierungsleuchte aus Aluminium im Farbton Nickel mit warmem oder neutralem Licht. Garantiert den höchsten Schutzgrad in Hinblick auf Stöße und eine hervorragende Beständigkeit gegen Staub und Flüssigkeiten. Damit ist sie die ideale Wahl für Garagen oder Durchgangsbereiche mit Fahrzeugverkehr.

Recessed step light in aluminium with nickel finish and warm or neutral light. It ensures maximum protection against impacts and excellent protection against dust and liquids. This makes it the ideal choice for garages or vehicle passageways.

**Material**

Aluminium

**Farbe**

Nickel



**Farbtemperatur**

3000K / 4000K



**Driver**

DC 24V

Konstantspannung nicht enthalten

**Material**

aluminium

**Colour**

nikel



**Colour temperature**

3000K / 4000K



**Driver**

DC 24V

constant voltage not included



**EASY DOMOTICA**

Parallelschaltung / Serie connection system  
Driver ab S./from p. 414  
Controller ab S./from p. 430



**LED-IMPACT24V-R1C**

8031414879298  
FANEU00006469

lumen

colour temp.

colour

recessed box

170 lm

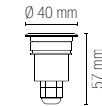
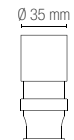

**Photometrie des Produkts / Photometric curve**

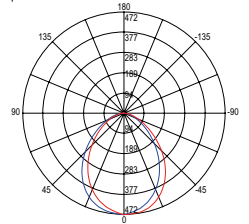

LED-IMPACT24V-R1C  
LED-IMPACT24V-Q1C



**LED-IMPACT24V-Q1C**

8031414879311  
FANEU00006466

lumen

colour temp.

colour

recessed box

170 lm

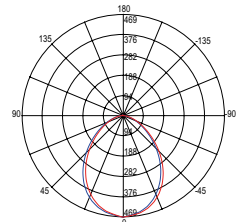
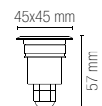
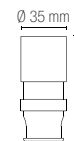

LED-IMPACT24V-R1M  
LED-IMPACT24V-Q1M

**LED-IMPACT24V-Q1M**

8031414879328  
FANEU00006467

lumen

watt

driver

beam angle

pressure loads

max 250 kg

Ø 35 mm



**Enthaltenes Zubehör / Accessories included**



x1

1 m Kabel / 1 m cable

# STEP





**Einbau-Orientierungsleuchte aus Aluminium mit silbernem Finish. Erhältlich mit warmem oder neutralem Licht, mit direktem oder mehrfachem Lichtstrahl, ist sie mit technischen Eigenschaften konzipiert, die hohe Leistungen in Hinblick auf extreme Stoßfestigkeit und Beständigkeit gegen Staub und Flüssigkeiten bieten.**

Recessed step light in aluminium with silver finish. Available with warm or neutral light, direct or multiple emission, it is designed with high-performance technical features for exceptional protection against impacts, dust and liquids.

**Material**  
Aluminium

**Farbe**  
Silber

**Farbtemperatur**  
3000K / 4000K



**Driver**  
DC 24V

Konstantspannung  
nicht enthalten

**Material**  
aluminium

**Colour**  
silver

**Colour temperature**  
3000K / 4000K



**Driver**  
DC 24V

constant voltage  
not included



**LED-STEP24V-R1C**

8031414879250  
FANEU00007473  
lumen

colour temp.	colour
170 lm	

recessed box



**LED-STEP24V-R1M**

8031414879267  
FANEU00007474  
lumen

colour temp.	colour
170 lm	

watt	2W
driver	DC 24V
beam angle	105°
pressure loads	max 250 kg
	Ø 35 mm

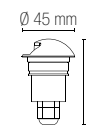
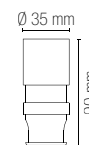

**LED-STEP24V-R4C**

8031414879274  
FANEU00007475  
lumen

colour temp.	colour
170 lm	

recessed box



**LED-STEP24V-R4M**

8031414879281  
FANEU00007476  
lumen

colour temp.	colour
170 lm	

watt	2W
driver	DC 24V
beam angle	105°
pressure loads	max 250 kg
	Ø 35 mm

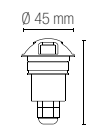
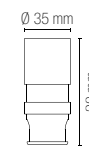

Parallelschaltung / Serie connection system  
Driver ab S./from p. 414  
Controller ab S./from p. 430

Photometrie des Produkts / Photometric curve

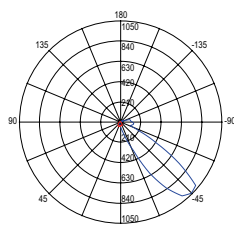

LED-STEP24V-R1C

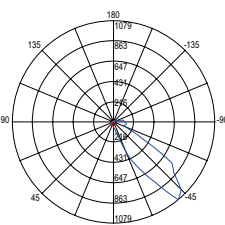

LED-STEP24V-R1M

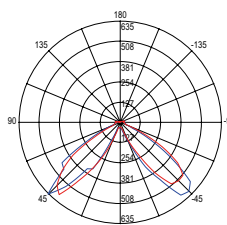

LED-STEP24V-R4C

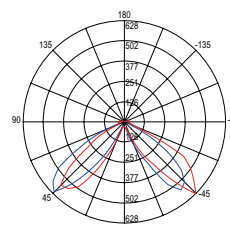

LED-STEP24V-R4M

Enthaltenes Zubehör / Accessories included



x1  
1 m Kabel / 1 m cable

# ELMO

**Orientierungsleuchte aus Aluminiumdruckguss im Farbton Silber. Sie wird in den Versionen mit einzelner, doppelter, mehrfacher oder oberem Lichtstrahl und zwei Farbtemperaturen angeboten. Hervorragende Stoßfestigkeit und Schutz vor Staub und Wasser.**

Wall light in die-cast aluminium with silver finish. Available in the versions: single, dual, multiple or higher emission lighting and dual colour temperatures. Excellent impact resistance and protection against dust and water.



---

**Material**

Aluminium

---

**Farbe**

Silber



---

**Farbtemperatur**

3000K / 4000K



---

**Driver**

DC 24V

Konstantspannung  
nicht enthalten

---

**Material**

aluminum

---

**Colour**

silver



---

**Colour temperature**

3000K / 4000K



---

**Driver**

DC 24V

constant voltage  
not included





		<b>LED-ELMO-R1C</b>	colour temp.	colour	
		8031414882823 FANEU00006143			
		lumen	59 lm		
		<b>LED-ELMO-R1M</b>	colour temp.	colour	
		8031414882830 FANEU00006144			
		lumen	65 lm		
		watt	0,5W		
		beam angle	90°		
		pressure loads	max 1000 kg		
					15 mm

		<b>LED-ELMO-R2C</b>	colour temp.	colour	
		8031414882847 FANEU00006145			
		lumen	116 lm		
		<b>LED-ELMO-R2M</b>	colour temp.	colour	
		8031414882854 FANEU00006146			
		lumen	121 lm		
		watt	1W		
		beam angle	90° x 2		
		pressure loads	max 1000 kg		
					15 mm

		<b>LED-ELMO-R4C</b>	colour temp.	colour	
		8031414882861 FANEU00006147			
		lumen	226 lm		
		<b>LED-ELMO-R4M</b>	colour temp.	colour	
		8031414882878 FANEU00006148			
		lumen	236 lm		
		watt	2W		
		beam angle	90° x 4		
		pressure loads	max 1000 kg		
					15 mm

		<b>LED-ELMO-UPC</b>	colour temp.	colour	
		8031414897247 FANEU00006150			
		lumen	360 lm		
		<b>LED-ELMO-UPM</b>	colour temp.	colour	
		8031414897254 FANEU00006151			
		lumen	380 lm		
		watt	3W		
		beam angle	180°		
		pressure loads	max 200 kg		
					15 mm



**I-ELMO-SPK**  
8031414888092  
FANEU00001776

Enthaltenes Zubehör /  
Accessories included



x1  
30 cm Kabel /  
30 cm cable

# WALK

Begehbarer Einbau-Flutlichtstrahler aus Edelstahl mit höchstem Stoßfestigkeitsgrad und hervorragendem Schutz gegen Staub und Flüssigkeiten. Erhältlich mit rechteckiger, runder oder quadratischer Basis und für warmes oder neutrales Licht ausgelegt.

Walkable recessed light in stainless steel with maximum impact resistance and excellent protection against dust and liquids. Available with a rectangular, round or square base and a choice of warm or neutral light.

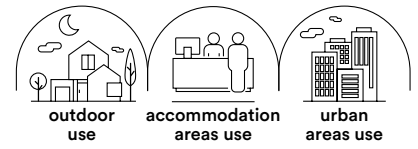

**Material**  
Edelstahl

**Farbtemperatur**  
4000K



**Driver**  
eingebaut

**Material**  
stainless steel

**Colour temperature**  
4000K



**Driver**  
built-in

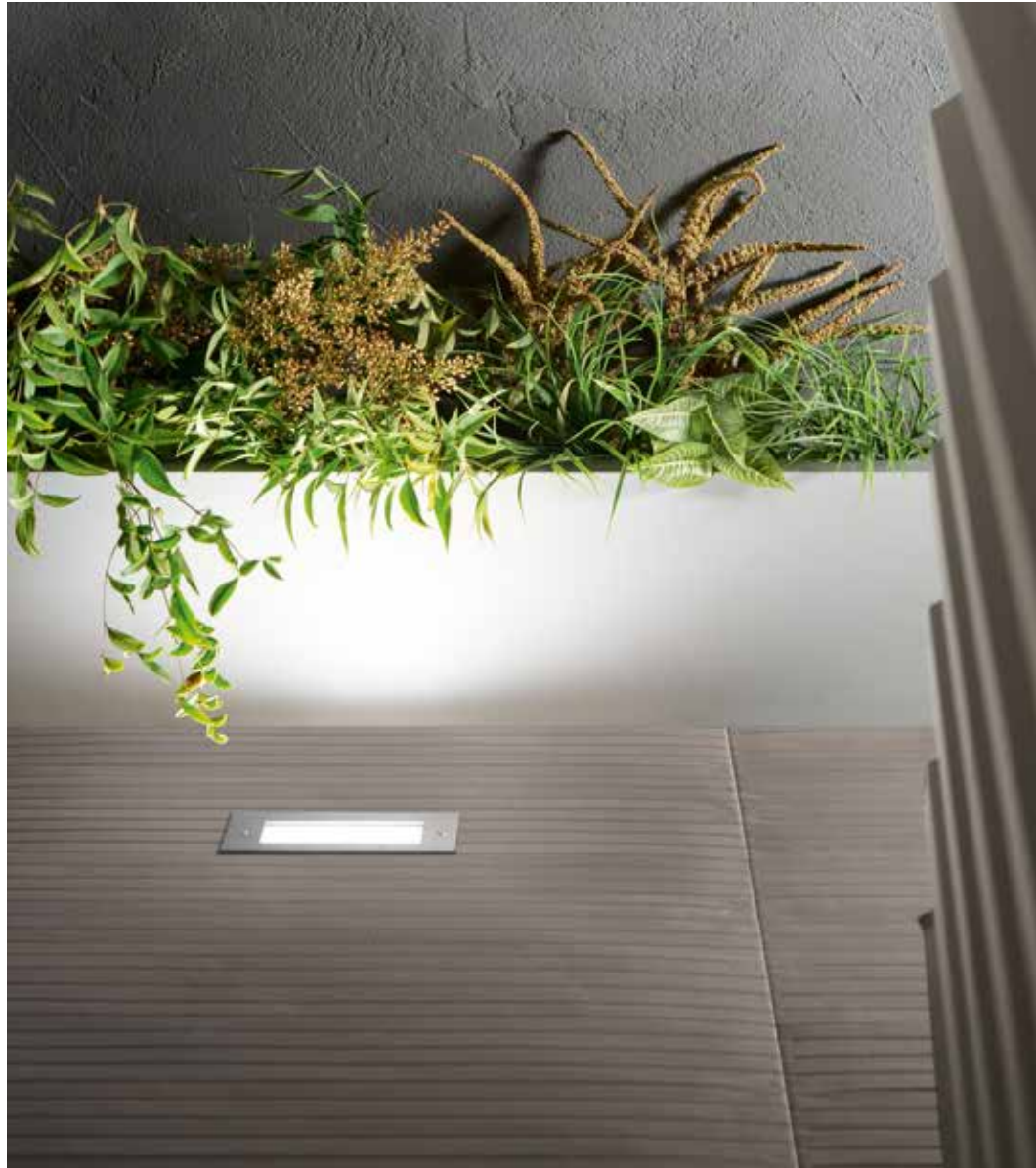

**LED-WALK-RT**  
8031414882816  
FANEU00007904  
lumen

colour temp. | colour | recessed box

1500 lm

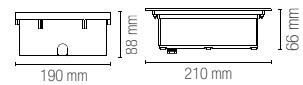

watt 12W  
beam angle 30°  
pressure loads max 2000 kg

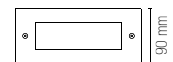

WALK



In.tec light EINBAU- UND ORIENTIERUNGSLEUCHTEN / INGROUND AND WALK LIGHTS

# WALK



	colour temp.	colour	recessed box
<b>LED-WALK-Q7C</b> 8031414885824 FANEU00007896 lumen			 88.5 mm Ø 63 mm
	345 lm		
<b>LED-WALK-Q7</b> 8031440355599 FANEU00007895 lumen			 66 mm 70 mm
	375 lm		
watt			3W
beam angle			30°
pressure loads			max 2000 kg



	colour temp.	colour	recessed box
<b>LED-WALK-Q11C</b> 8031414885800 FANEU00007892 lumen			 94 mm Ø 85 mm
	930 lm		
<b>LED-WALK-Q11</b> 8031440355575 FANEU00007891 lumen			 77.8 mm 100 mm
	990 lm		
watt			8W
beam angle			30°
pressure loads			max 2000 kg



	colour temp.	colour	recessed box
<b>LED-WALK-Q14C</b> 8031414885817 FANEU00007894 lumen			 106 mm Ø 133 mm
	1400 lm		
<b>LED-WALK-Q14</b> 8031440355551 FANEU00007893 lumen			 91.5 mm 140 mm
	1500 lm		
watt			12W
beam angle			30°
pressure loads			max 2000 kg

## Photometrie des Produkts / Photometric curve

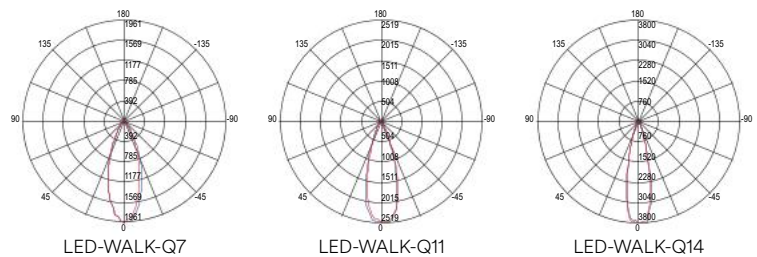



	colour temp.	colour	recessed box
<b>LED-WALK-R7C</b> 8031414885855 FANEU00007903 lumen			 88,5 mm Ø 63 mm
345 lm			
<b>LED-WALK-R7</b> 8031440355582 FANEU00007902 lumen			 66 mm Ø 70 mm
375 lm			
watt	3W		
beam angle	30°		
pressure loads	max 2000 kg		



	colour temp.	colour	recessed box
<b>LED-WALK-R11C</b> 8031414885831 FANEU00007899 lumen			 94 mm Ø 85 mm
930 lm			
<b>LED-WALK-R11</b> 8031440355568 FANEU00007898 lumen			 77,8 mm Ø 117 mm
990 lm			
watt	8W		
beam angle	30°		
pressure loads	max 2000 kg		



	colour temp.	colour	recessed box
<b>LED-WALK-R14C</b> 8031414885848 FANEU00007901 lumen			 106 mm Ø 133 mm
1400 lm			
<b>LED-WALK-R14</b> 8031440355544 FANEU00007900 lumen			 91,5 mm Ø 140 mm
1500 lm			
watt	12W		
beam angle	30°		
pressure loads	max 2000 kg		

Photometrie des Produkts / Photometric curve

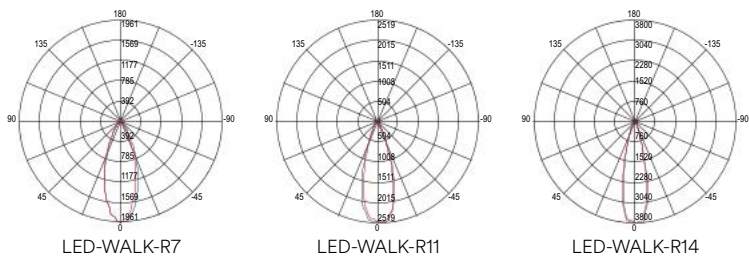

# DECK





**Begehbarer LED-Strahler aus Aluminium mit silbernem Finish. Das essenzielle Design umschließt technische Eigenschaften auf hohem Niveau in Hinblick auf den Schutz vor Stößen, Flüssigkeiten und Staub und bietet dabei hohe Farbwiedergabe und Blendschutzoptik.**

Walkable LED light in aluminium with silver finish. Its minimalist design incorporates hi-tech features for protection against impacts, liquids and dust, with high colour rendering and anti-glare features.

**Material**  
Aluminium

**Farbe**  
Silber



**Farbtemperatur**  
3000K / 4000K



**Driver**  
inklusive

**Material**  
aluminum

**Colour**  
silver



**Colour temperature**  
3000K / 4000K



**Driver**  
included



Photometrie des Produkts / Photometric curve

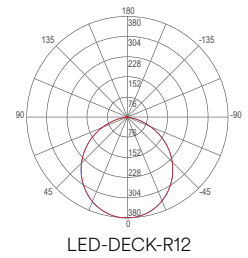

	colour temp.	colour
<b>LED-DECK-R12C</b> 8031414937561 FANEU00027389 lumen	1100 lm	
<b>LED-DECK-R12M</b> 8031414937578 FANEU00027390 lumen	1100 lm	
watt	9W	
beam angle	107°	
pressure loads	max 250 kg	
	Ø 115 mm	

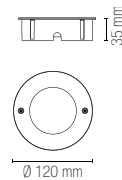

# GROUND

Anthrazitfarbene Orientierungsleuchte aus Aluminiumdruckguss. Die angebotenen Modelle bieten Beleuchtung mit einem, doppeltem, mehrfachem oder oberem Lichtstrahl und zwei wählbaren Farbtemperaturen. Ideal für die Outdoor-Installation, auch in Grünflächen, dank des erhältlichen Pflocks.

Wall light in die-cast aluminium with anthracite finish. The available versions feature single, dual, multiple or higher emission lighting and selectable dual colour temperatures. Ideal for outdoor installation, also in green areas, with the provided stake.



---

**Material**

Aluminium

---

**Farbe**

Anthrazit



---

**Wählbare Farbtemperatur**

3000K / 4000K



---

**Driver**

DC 24V

Konstantspannung  
nicht enthalten

---

**Material**

aluminium

---

**Colour**

anthracite



---

**Selectable color temperature**

3000K / 4000K



---

**Driver**

DC 24V

constant voltage  
not included

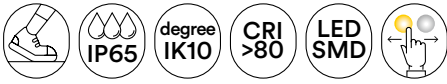

**LED-GROUND-R1**

8031414897261  
FANEU00006301  
lumen

colour temp.	colour

730 lm

watt	6W
beam angle	120°
pressure loads	max 2000 kg

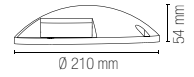

**LED-GROUND-R2**

8031414897278  
FANEU00006304  
lumen

colour temp.	colour

1460 lm

watt	12W
beam angle	120°
pressure loads	max 2000 kg

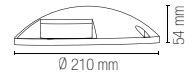

**LED-GROUND-R4**

8031414897285  
FANEU00006305  
lumen

colour temp.	colour

1960 lm

watt	16W
beam angle	120°
pressure loads	max 2000 kg

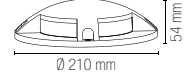

**LED-GROUND-UP**

8031414897292  
FANEU00006308  
lumen

colour temp.	colour

1480 lm

watt	12W
beam angle	120°
pressure loads	max 1000 kg



**LED-GROUND-SPK**

8031414897308  
FANEU00006307

# HUMMER

**Befahrbarer Einbau-Strahler aus Edelstahl mit überlegenen technischen Eigenschaften in Hinblick auf Stöße, Staub und Flüssigkeiten. Er kann mit verschiedenen Finishes - Silber, Schwarz oder Corten - und Beleuchtungstypen gewählt werden.**

Drive-over step light in stainless steel with superior technical specifications for protection against impacts, dust and liquids. Available in a choice of finishes – silver, black or corten – and types of emission.





# DRIVE

Begehbarer Einbau-Strahler aus Edelstahl mit silbernem Finish und runder oder quadratischer Basis. Dazu konzipiert, den höchsten Grad an Stoßfestigkeit, umfassenden Schutz vor Staub und bei vorübergehendem Eintauchen zu garantieren.

Walkable recessed light in stainless steel with silver finish and round or square base. Designed to guarantee maximum impact resistance and full protection against dust and temporary immersion.





Glühbirne nicht  
enthalten /  
Light bulb  
not included



colour

recessed box

**I-DRIVE-R1**

8031440313261  
FANEU00001625



1 x GU10 MAX 42W  
pressure loads max 500 kg

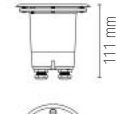
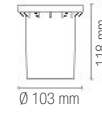

colour

recessed box

**I-DRIVE-Q1**

8031440313254  
FANEU00001622



1 x GU10 MAX 42W  
pressure loads max 500 kg

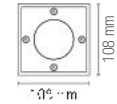
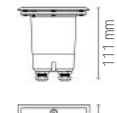
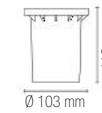

colour

recessed box

**I-DRIVE-M-R1**

8031440313247  
FANEU00001620



1 x GU10 MAX 42W  
pressure loads max 500 kg

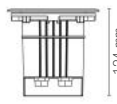

Glühbirne nicht  
enthalten /  
Light bulb  
not included



colour

recessed box

**I-DRIVE-E27**

8031440313230  
FANEU00001618



1 x E27 MAX 60W  
pressure loads max 500 kg



# OASIS





**Wandleuchte aus Polycarbonat, in den Farben Weiß oder Schwarz erhältlich. Mit Auswahl des Weißtons - warmes, neutrales und kaltes Licht -, hoher Farbwiedergabe und hoher Beständigkeit gegen Witterungseinflüsse. Durch ihren sauberen Stil ist sie sowohl für Außen- als auch für Innenbereiche geeignet.**  
 Wall lamp in polycarbonate, available in white or black. Selectable warm, neutral and cool white light, high colour rendering and high protection against adverse weather conditions. With its sleek design, it can be placed in outdoor or indoor spaces.

- Material**  
PC

---

- Farbe**  
Weiß  
Schwarz

---

- Wählbare Farbtemperatur**  
3000K / 4200K / 6500K

---

- Driver**  
eingebaut

---

- Material**  
PC

---

- Colour**  
white  
black

---

- Selectable color temperature**  
3000K / 4200K / 6500K

---

- Driver**  
built-in



	colour temp.	colour
<b>LED-W-OASIS-BCO</b>		
8031414927944	<span style="color: yellow;">●</span> <span style="color: gray;">●</span> <span style="color: blue;">●</span>	<span style="color: white;">●</span>
FANEU00027282		
lumen	370 lm	
<hr/>		
watt	3W	
beam angle	100°	
<hr/>		



	colour temp.	colour
<b>LED-W-OASIS-NER</b>		
8031414927951	<span style="color: yellow;">●</span> <span style="color: gray;">●</span> <span style="color: blue;">●</span> <span style="color: black;">●</span>	
FANEU00027283		
lumen	370 lm	
<hr/>		
watt	3W	
beam angle	100°	
<hr/>		

# STEPLIGHT

LED-Orientierungsleuchte aus Thermoplast mit anthrazitfarbenem Finish. Für die Verwendung in Außenbereichen ausgelegt, kann auch in Durchgangsbereichen im Inneren von Beherbergungsbetrieben eingesetzt werden.

LED wall light in thermoplastic with anthracite finish. Designed for outdoor use, it can also be installed in indoor pass-through areas in hospitality facilities.

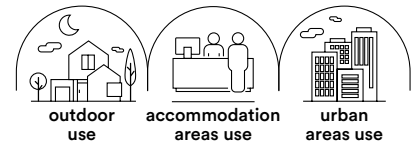

**Material**  
Thermoplast

**Farbe**  
Schwarz



**Farbtemperatur**  
4000K



**Driver**  
eingebaut

**Material**  
thermoplastic

**Colour**  
black



**Colour temperature**  
4000K



**Driver**  
built-in



**LED-STEPLIGHT**  
8031414882304  
FANEU00007477  
lumen

colour temp. | colour



95 lm

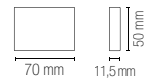

watt 1W  
beam angle 120°

# SHELBY

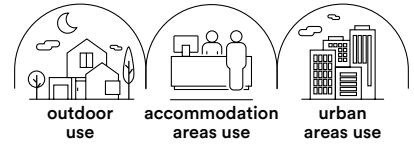

LED-Orientierungsleuchte aus Aluminium mit geprägtem Finish im Farbton Anthrazit. Als elegante Lösung für Outdoor- und Indoor-Bereiche bietet Shelby die Wahl von warmem oder neutralem Licht und eine hervorragende Farbwiedergabe.

LED wall light in aluminium with anthracite embossed finish. An elegant solution for outdoor or indoor spaces, Shelby provides selectable warm or neutral light and excellent colour rendering.

**Material**

Aluminium

**Farbe**

Anthrazit, geprägt



**Wählbare Farbtemperatur**

3000K / 4000K



**Driver**

eingebaut

**Material**

aluminium

**Colour**

embossed anthracite



**Selectable color temperature**

3000K / 4000K



**Driver**

built-in



**LED-W-SHELBY-130**

8031440361002  
FANEU00007834

lumen

colour temp.	colour
445 lm	

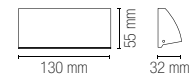

watt

4W

beam angle

120°



**LED-W-SHELBY-170**

8031440361019  
FANEU00007837

lumen

colour temp.	colour
670 lm	

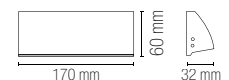

watt

6W

beam angle

120°

EINBAU- UND ORIENTIERUNGSLEUCHTEN / INGROUND AND WALK LIGHTS

In.tec light

# ONYX



**Material**

Aluminium

**Farbe**

Weiß  
Schwarz



**Farbtemperatur**

3000K / 4000K



**Driver**

eingebaut

**Material**

aluminum

**Colour**

white  
black



**Colour temperature**

3000K / 4000K



**Driver**

built-in





**Orientierungsleuchte aus Aluminiumdruckguss im kompakten Format mit geprägtem Finish in Schwarz oder Weiß. Höchster Schutzgrad gegen Stöße, hohe Farbwiedergabe und minimalistisches Design für Anwendungen in sämtlichen Außen- und Innenbereichen.**  
 Step light in die-cast aluminium, compact and available in black or white embossed finish. Maximum protection against impacts, high colour rendering and minimalist design for use in any outdoor or indoor space.



	colour temp.	colour
<b>INC-ONYX-Q1C BCO</b> 8031414929429 FANEU00026038 lumen	430 lm	
<b>INC-ONYX-Q1 BCO</b> 8031414864089 FANEU00004978 lumen	420 lm	

recessed box

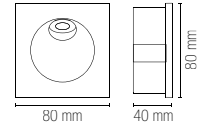

<b>INC-ONYX-Q1C NERO</b> 8031414929436 FANEU00026039 lumen	430 lm	
<b>INC-ONYX-Q1 NERO</b> 8031440361262 FANEU00004979 lumen	420 lm	

watt	3W
beam angle	45°
	Ø 68 mm



	colour temp.	colour
<b>INC-ONYX-R1C BCO</b> 8031414929443 FANEU00026040 lumen	430 lm	
<b>INC-ONYX-R1 BCO</b> 8031440361248 FANEU00004982 lumen	420 lm	

recessed box

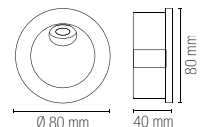

<b>INC-ONYX-R1C NERO</b> 8031414929450 FANEU00026041 lumen	430 lm	
<b>INC-ONYX-R1 NERO</b> 8031440361255 FANEU00004983 lumen	420 lm	

watt	3W
beam angle	45°
	Ø 68 mm

# STRATOS

Einbau-Orientierungsleuchte, kompatibel mit der Unterbringung in Abzweigdose 503, 504 oder 506. Erhältlich mit Blenden aus Aluminium in den Farben Weiß, Anthrazit, Silber oder Corten, gestattet die individuelle Auslegung der Kelvin-Temperatur.

Recessed step light box, compatible with 503, 504 or 506 junction boxes. Available with an aluminium mounting plate in white, anthracite, silver or corten, and customisable Kelvin setting.



STRATOS



In.tec light EINBAU- UND ORIENTIERUNGSLUCHTEN / INGROUND AND WALK LIGHTS

# STRATOS

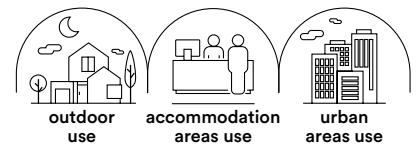

**Material**  
Aluminium

**Farbe**  
Weiß  
Silber  
Schwarz  
Corten



**Wählbare Farbtemperatur**  
3000K / 4000K / 6000K



**Driver**  
eingebaut

**Material**  
aluminum

**Colour**  
white  
silver  
black  
corten



**Selectable color temperature**  
3000K / 4000K / 6000K



**Driver**  
built-in



## INC-STRATOS-503

8031414888184  
FANEU00005170

lumen

colour temp.



360 lm

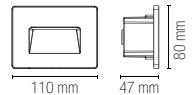

watt 3W  
beam angle 120°

colour

## INC-STRATOS-503W

8031414886890  
FANEU00005177



## INC-STRATOS-503S

8031414888214  
FANEU00005176



## INC-STRATOS-503B

8031414888191  
FANEU00005174



## INC-STRATOS-503C

8031414888207  
FANEU00005175



Abzweigdose 503  
503 junction box  
Nicht enthalten /  
not included

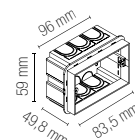



**INC-STRATOS-504**

8031414888221  
FANEU00005178

lumen

colour temp.

360 lm

watt	3W
beam angle	120°

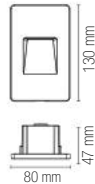

**INC-STRATOS-506**

8031414888276  
FANEU00005183

lumen

colour temp.

600 lm

watt	5W
beam angle	120°

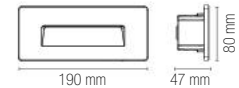

**INC-STRATOS-504W**

8031414888269  
FANEU00005182

**INC-STRATOS-504S**

8031414888252  
FANEU00005181

**INC-STRATOS-504B**

8031414888238  
FANEU00005179

**INC-STRATOS-504C**

8031414888245  
FANEU00005180



**INC-STRATOS-506W**

8031414888313  
FANEU00005190

**INC-STRATOS-506S**

8031414888306  
FANEU00005189

**INC-STRATOS-506B**

8031414888283  
FANEU00005187

**INC-STRATOS-506C**

8031414888290  
FANEU00005188



Abzweigdose 503  
503 junction box  
Nicht enthalten /  
not included

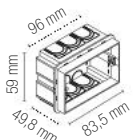

Abzweigdose 504  
504 junction box  
Nicht enthalten /  
not included

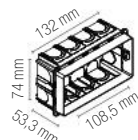

Abzweigdose 506L  
506L junction box  
Nicht enthalten /  
not included

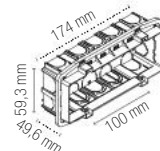

# SLAB

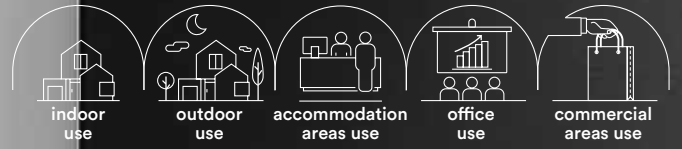

---

## Material

Aluminiumstruktur  
und Diffusor  
aus Hartglas

---

## Wählbare Farbtemperatur

3000K / 4000K / 5500K



---

## Driver

eingebaut

---

## Material

structure in  
aluminum and  
tempered glass diffuser

---

## Selectable color temperature

3000K / 4000K / 5500K



---

## Driver

built-in



**Einbau-Orientierungsleuchte zur Unterbringung in Abzweigdose 502, 503 oder 506. Der Diffusor besteht aus weißem Hartglas, mit Einstellung der Farbtemperatur. Slab ist in verschiedenen Designausführungen erhältlich und für die Verwendung in Gewerbebereichen, Büros oder Beherbergungsbetrieben konzipiert.**  
 Recessed step light box, compatible with 502, 503 or 506 junction boxes. White tempered glass diffuser, with colour temperature adjustment. Available in various designs, Slab is designed for use in retail spaces, offices or hospitality facilities.



**INC-SLAB-502**  
 8031414888177  
 FANEU00005122  
 lumen

colour temp. | colour  
  
 360 lm

watt 3W  
 beam angle 120°  
 Ø 60 mm

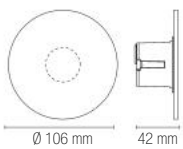

Federn enthalten /  
 spring included



**INC-SLAB-503**  
 8031414864683  
 FANEU00005123  
 lumen

colour temp. | colour  
  
 440 lm

watt 3W  
 beam angle 120°  
 92 × 55 × 31 mm

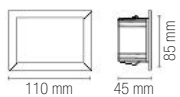

**INC-SLAB-506**  
 8031414877232  
 FANEU00005127  
 lumen

colour temp. | colour  
  
 730 lm

watt 5W  
 beam angle 120°  
 163 × 60 × 50 mm

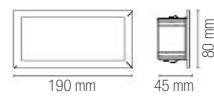

**Doppeltes Befestigungssystem / Double fixing system**

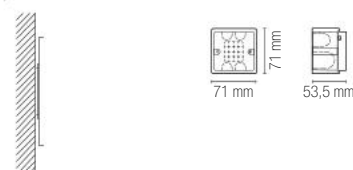

Wand- oder  
 Deckeneinbau /  
 Recessed wall or  
 ceiling mounting

Abzweigdose 502E  
 502E junction box  
**Nicht enthalten / not included**

Abzweigdose 503  
 503 junction box  
**Nicht enthalten / not included**

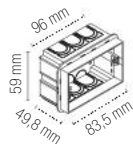

Abzweigdose 506L  
 506L junction box  
**Nicht enthalten / not included**

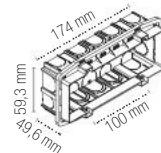

# BREEN



---

**Material**

Polycarbonat

---

**Farbe**

Weiß, geprägt  
Anthrazit, geprägt  
Corten, geprägt



---

**Wählbare  
Farbtemperatur**  
3000K / 4000K

---

**Driver**

eingebaut

---

**Material**

polycarbonate

---

**Colour**

embossed white  
embossed anthracite  
embossed corten



---

**Selectable color  
temperature**  
3000K / 4000K

---

**Driver**

built-in

---



**Einbau-Orientierungsleuchte zur Unterbringung in Abzweigdose 503 oder 506 in den Farben Weiß, Anthrazit oder geprägtem Corten. Durch den erlesenen Stil und die einstellbare Farbtemperatur ist sie die ideale Wahl für Büros, Gewerberäume, Hotels und Restaurants.**

Recessed step light box, compatible with 503 or 506 junction boxes. Available in white, anthracite or corten embossed finish. With its sophisticated style and adjustable colour temperature, it is the perfect choice for offices, retail spaces, hotels or restaurants.



**INC-BREEN-503 BCO**

8031414864690  
FANEU00004773  
lumen

colour temp. | colour

290 lm

**INC-BREEN-503 ANT**

8031414866809  
FANEU00004772  
lumen

300 lm

**INC-BREEN-503 BRO**

8031414888139  
FANEU00004774  
lumen

290 lm

watt 3W

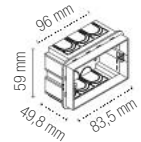
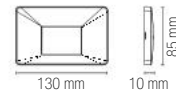

Abzweigdose 503  
503 junction box  
**Nicht enthalten / not included**



**INC-BREEN-506 BCO**

8031414888153  
FANEU00004776  
lumen

colour temp. | colour

380 lm

**INC-BREEN-506 ANT**

8031414888146  
FANEU00004775  
lumen

380 lm

**INC-BREEN-506 BRO**

8031414888160  
FANEU00004777  
lumen

380 lm

watt 4W

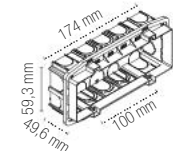
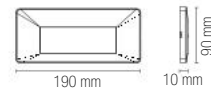

Abzweigdose 506L  
506L junction box  
**Nicht enthalten / not included**

**Doppeltes Befestigungssystem / Double fixing system**



Wandbefestigung /  
wall fixing

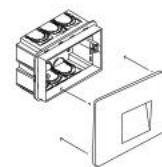

Befestigung auf Dose 503 /  
fixing on box 503  
**Nicht enthalten / not included**

# SMILE



---

**Material**

PC

---

**Farbe**

Weiß  
Anthrazit



---

**Wählbare  
Farbtemperatur**

3000K / 3500K / 4000K



---

**Driver**

eingebaut

---

**Material**

PC

---

**Colour**

white  
anthracite



---

**Selectable color  
temperature**

3000K / 3500K / 4000K



---

**Driver**

built-in





**LED-Orientierungsleuchte aus Aluminium mit doppelter Anbringung:  
an der Wand oder auf Abzweigdose 502E. Das Modell bietet zwei  
Farbgebungen - Weiß oder Anthrazit -, die individuelle Wahl der  
Kelvin-Temperatur und eine für die Sicht angenehme Beleuchtung.**

LED wall light in aluminium with dual mounting system: on wall or on 502E junction box. The model is available in two colours - white or anthracite - with customisable Kelvin setting and eye-friendly lighting.



**LED-SMILE-BCO**  
8031414881574  
FANEU00007433  
lumen

colour temp.	colour

250 lm

watt	3W
beam angle	100°

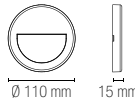

**Doppeltes Befestigungssystem / Double fixing system**



Wandbefestigung / wall fixing

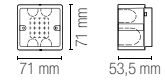

Befestigung auf Dose 502E / fixing on box 502E  
**Nicht enthalten / not included**



**LED-SMILE-ANT**  
8031414881567  
FANEU00007432  
lumen

colour temp.	colour

300 lm

watt	3W
beam angle	100°

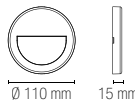

**Doppeltes Befestigungssystem / Double fixing system**



Wandbefestigung / wall fixing

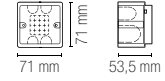

Befestigung auf Dose 502E / fixing on box 502E  
**Nicht enthalten / not included**

# BOLT



**Material**  
Aluminium  
und Stahlblenden

**Farbe**  
Nickel  
Weiß



**Wählbare Farbtemperatur**  
2800K / 3500K / 4500K / 5000K / 6500K



**Driver**  
eingebaut

**Material**  
aluminum and  
steel frames

**Colour**  
nikel  
white



**Selectable color temperature**  
2800K / 3500K / 4500K / 5000K / 6500K



**Driver**  
built-in

**Für die Unterbringung in den Abzweigdosen 503 ausgelegte Einbau-Orientierungsleuchte. Mit Bewegungs- und Dämmerungssensor und mit austauschbarer doppelter Stahlplakette in den Farben Nickel oder Weiß erhältlich.**

Recessed step light, compatible with 503 junction boxes. Fitted with a motion sensor and twilight sensor, it is available with a dual interchangeable steel mounting plate with a nickel or white finish.



Mehrere Produkte seitlich in einem Mindestabstand von 2 m installieren / Install multiple bolt 503S within 2 m of each other



Die Produkte wegen möglichen Konflikts nicht einander gegenüberliegend installieren / Do not install products one of facing each other for possible conflict



Das Produkt darf nicht in der Nähe einer starken und konstanten Lichtquelle mit über 20 LUX installiert werden / Do not install the bolt 503S near a light source with intensity over 20 LUX



	colour temp.	colour		colour temp.	colour		
<b>INC-BOLT-503S</b> 8031414866281 FANEU00004763 lumen			200 lm	<b>INC-BOLT-506S</b> 8031414936694 FANEU00026611 lumen		650 lm	
watt			3W	watt			5W
beam angle			120°	beam angle			120°

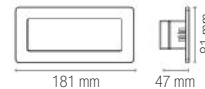
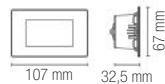

**Enthaltenes Zubehör / Accessories included**



**2x**  
Blenden /  
frames



**2x**  
Halterungen /  
brackets

Abzweigdose 503  
503 junction box  
**Nicht enthalten / not included**

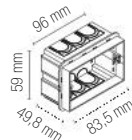

Abzweigdose 506L  
506L junction box  
**Nicht enthalten / not included**

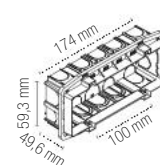

**Enthaltenes Zubehör / Accessories included**



5m  
120°  
**60"**

Regulierbarer  
Bewegungssensor /  
Adjustable  
motion sensor

on 2 LUX

off 1000 LUX

Dämmerungs-  
sensor /  
Crepuscular  
sensor



**Material**  
PC und  
Stahlblenden

**Farbe**  
Nickel  
Weiß



**Wählbare  
Farbtemperatur**  
3000K / 4500K / 6500K



**Driver**  
eingebaut

**Material**  
PC and  
steel frames

**Colour**  
nikel  
white



**Selectable color  
temperature**  
3000K / 4500K / 6500K



**Driver**  
built-in

**Einbau-Orientierungsleuchte zur Unterbringung in Abzweigdose 503 oder 506L. Der Artikel wird mit doppelter austauschbarer Stahlplakette in den Farben Nickel oder Weiß geliefert. Bietet drei wählbare Farbtemperaturen.**

Recessed step light, compatible with 503 or 506L junction boxes. The product is provided with a dual interchangeable steel mounting plate with a nickel or white finish. Available with 3 selectable colour temperatures.



	colour temp.	colour		colour temp.	colour	
<b>INC-BOLT-503CCT</b> 8031414881543 FANEU00004759 lumen						
	350 lm					
watt				3W		
beam angle				120°		
<b>INC-BOLT-506CCT</b> 8031414881550 FANEU00004766 lumen						
	650 lm					
watt				5W		
beam angle				120°		

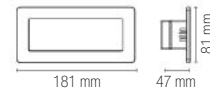
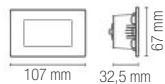

**Enthaltenes Zubehör /  
Accessories included**



**2x**  
Blenden /  
frames



**2x**  
Halterungen /  
brackets

Abzweigdose 503  
503 junction box  
**Nicht enthalten / not included**

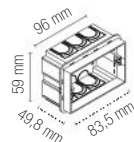

Abzweigdose 506L  
506L junction box  
**Nicht enthalten / not included**

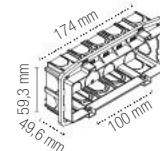





**Solarleuchten / Solar lamps**  
outdoor



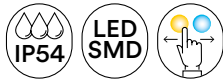

**Koordinierte Kollektion mit LED-Wand- und Bodenleuchte aus Polycarbonat mit anthrazitfarbenem Finish. Mit Solaraufladung und Aktivierungstaste des Dämmerungssensors. Erhältlich mit sehr warmer weißer oder Tageslichtbeleuchtung.**

A coordinated collection comprising a wall light and a LED bollard light in polycarbonate with anthracite finish. With solar charging and twilight sensor activation button. Available with very warm white or daylight lighting.

**Material**  
PC

**Farbe**  
Anthrazit



**Farbtemperatur**  
2700K / 6500K



**Driver**  
eingebaut

**Material**  
PC

**Colour**  
anthracite



**Colour temperature**  
2700K / 6500K



**Driver**  
built-in



**LED-MAEVE-AP**  
8031414928002  
FANEU00006742  
lumen

colour temp.	colour

300 lm

watt	2,8W
beam angle	120°

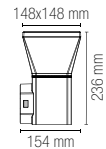

**LED-MAEVE-P80**  
8031414928019  
FANEU00006743  
lumen

colour temp.	colour

300 lm

watt	2,8W
beam angle	120°

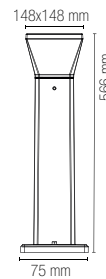

**Enthaltenes Zubehör / Accessories included**



Solarpanel / Solar panel



**Li-ion 3,7V 4000 mAh**  
Batterie nicht ersetzbar /  
Battery not replaceable /



Dämmerungssensor,  
ON/OFF-TASTE /  
Crepuscular sensor,  
ON OFF button

# GIZAH

**LED-Wandleuchte aus Polycarbonat, erhältlich mit quadratischer oder rechteckiger Form in der Farbe Anthrazit. Die Wandleuchte ist mit Solarpanel, eingebautem Bewegungssensor und verstellbarer Lichtstärke und Einschaltdauer ausgestattet.**

LED wall lamp in polycarbonate, available in a square or rectangular version with anthracite finish. The wall lamp is supplied with a solar panel, integrated motion sensor with adjustable brightness intensity and lighting duration.



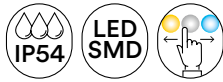

- Material**  
PC

---

- Farbe**  
Anthrazit

●

---

- Farbtemperatur**  
3000K / 4000K / 6500K

● ● ●

---

- Driver**  
eingebaut

---

- Material**  
PC

---

- Colour**  
anthracite

●

---

- Colour temperature**  
3000K / 4000K / 6500K

● ● ●

---

- Driver**  
built-in



<b>LED-GIZAH-Q</b> 8031414931057 FANEU00023668 lumen	colour temp.	● ● ● ●	colour
	500 lm		
watt	4W		
beam angle	120°		

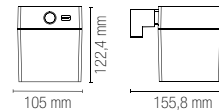

<b>LED-GIZAH-RT</b> 8031414931064 FANEU00023669 lumen	colour temp.	● ● ● ●	colour
	500 lm		
watt	4W		
beam angle	120°		



**Enthaltenes Zubehör / Accessories included**

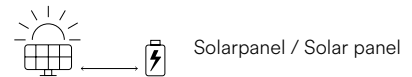

**Li-ion 3,7V 2000 mAh**  
Batterie nicht ersetzbar /  
Battery not replaceable

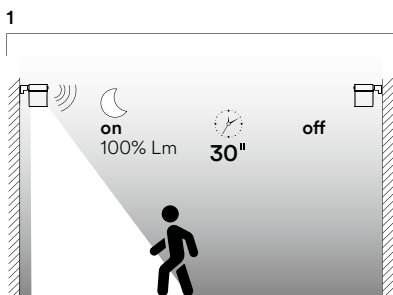

Bewegungssensor 100 % Licht  
Nach 30 Sekunden OFF /  
Motion sensor 100% light  
After 30 seconds OFF

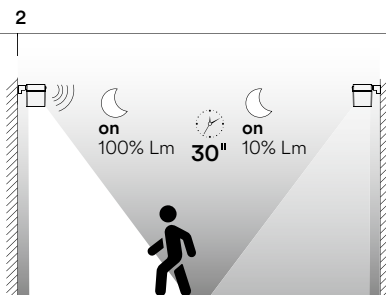

Bewegungssensor 100 % Licht  
Nach 30 Sekunden 10 % Licht /  
Motion sensor 100% light  
After 30 seconds 10% light

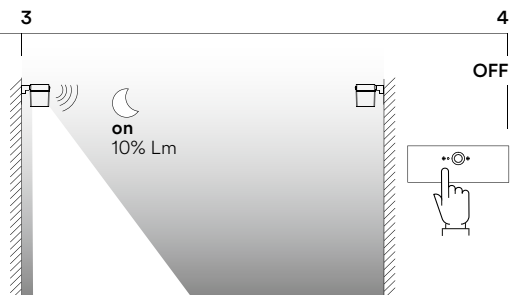

Dämmerungssensor 10 % Licht  
Nach < 15 Lux OFF /  
Crepuscular sensor 10% light  
After < 15 lux OFF do

# NASA



LED-Flutlichtleuchte aus schwarzem Polycarbonat mit um 180° verstellbarem Lichtpunkt. Mit Solarpanel und aufladbarer Batterie ausgestattet, wird sie für beste Energieausbeute mit Bewegungs- und Dämmerungssensor angeboten.

LED floodlight in black polycarbonate with 180° adjustable light point. Supplied with a solar panel and rechargeable battery, it comes with a motion sensor and twilight sensor for maximum energy saving.



**Material**  
PC

**Farbe**  
Schwarz



**Farbtemperatur**  
4000K



**Driver**  
eingebaut

**Material**  
PC

**Colour**  
black



**Colour temperature**  
4000K



**Driver**  
built-in

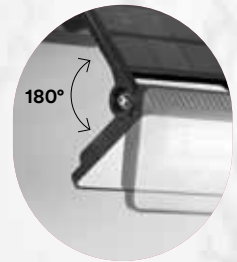

### LED-NASA-SOLAR

8031414931040  
FANEU00023667  
lumen

colour temp. colour

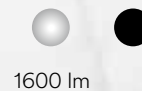

1600 lm

watt 12W  
beam angle 120°

### Enthaltenes Zubehör / Accessories included



Solarpanel / Solar panel



**Li-ion 3,7V 1800 mAh**  
Batterie nicht ersetzbar /  
Battery not replaceable

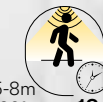

5-8m  
120°

Bewegungssensor /  
Adjustable motion sensor

18"

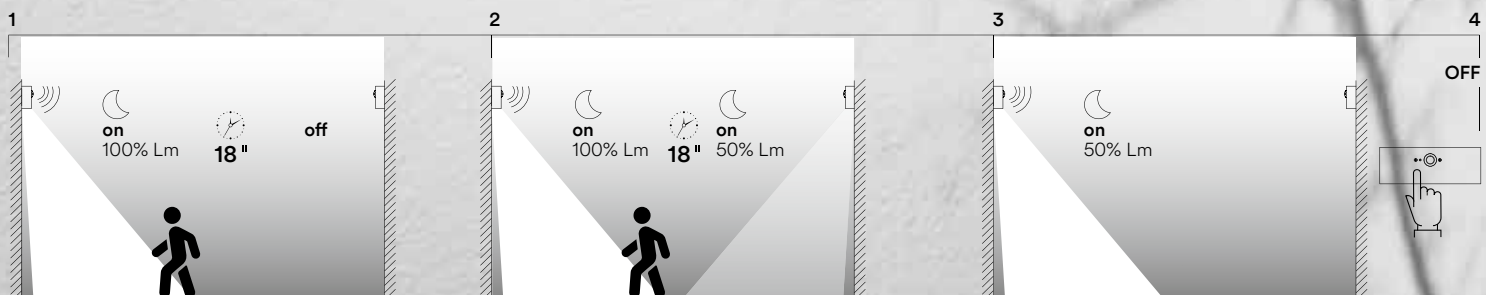

Bewegungssensor 100 % Licht  
Nach 18 Sekunden OFF /  
Motion sensor 100% light  
After 18 seconds OFF

Bewegungssensor 100 % Licht  
Nach 18 Sekunden 50 % Licht /  
Motion sensor 100% light  
After 18 seconds 50% light

Dämmerungssensor 50 % Licht  
Nach < 15 Lux OFF /  
Crepuscular sensor 50% light  
After < 15 lux OFF do

# NASA



LED-Flutlichtleuchte aus schwarzem Polycarbonat mit um 180° verstellbarem Lichtpunkt. Mit Solarpanel und aufladbarer Batterie ausgestattet, wird sie für beste Energieausbeute mit Bewegungs- und Dämmerungssensor angeboten.

LED floodlight in black polycarbonate with 180° adjustable light point. Supplied with a solar panel and rechargeable battery, it comes with a motion sensor and twilight sensor for maximum energy saving.

**Material**  
PC

**Farbe**  
Schwarz



**Farbtemperatur**  
4000K



**Driver**  
eingebaut

**Material**  
PC

**Colour**  
black



**Colour temperature**  
4000K



**Driver**  
built-in

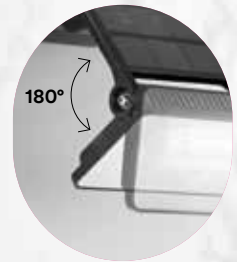

### LED-NASA-SOLAR

8031414931040  
FANEU00023667  
lumen

colour temp. | colour

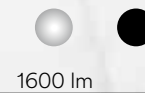

1600 lm

watt | 12W  
beam angle | 120°

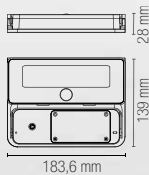

#### Enthaltenes Zubehör / Accessories included



Solarpanel / Solar panel



**Li-ion 3,7V 1800 mAh**  
Batterie nicht ersetzbar /  
Battery not replaceable



Bewegungssensor /  
Adjustable motion sensor

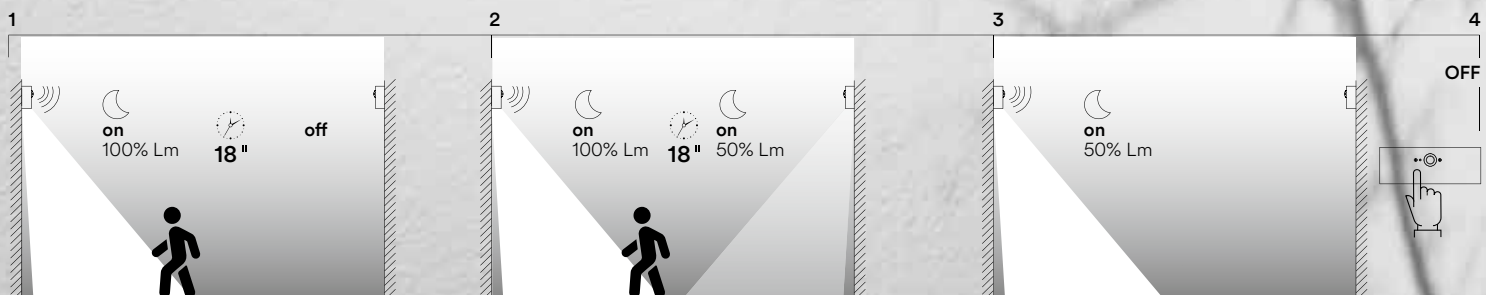

Bewegungssensor 100 % Licht  
Nach 18 Sekunden OFF /  
Motion sensor 100% light  
After 18 seconds OFF

Bewegungssensor 100 % Licht  
Nach 18 Sekunden 50 % Licht /  
Motion sensor 100% light  
After 18 seconds 50% light

Dämmerungssensor 50 % Licht  
Nach < 15 Lux OFF /  
Crepuscular sensor 50% light  
After < 15 lux OFF do

# GLASER

Glaser ist die batteriebetriebene Flutlichtleuchte mit Solaraufladung, die mittels Fernbedienung standortfern gesteuert werden kann. Sie bietet eine hohe Farbwiedergabe und optimalen IP-Schutz vor Staub und Wasserstrahlen und darüber hinaus Stoßfestigkeit. Der Artikel ist in verschiedenen Größen erhältlich.

Glaser is a battery-powered floodlight with remote control solar charging. It provides high colour rendering and excellent IP protection against dust and water jets, as well as protection against impacts. The product is available in various sizes.



---

**Material**

Aluminium

---

**Farbe**

Silber



---

**Farbtemperatur**

3000K / 4000K



---

**Material**

aluminum

---

**Colour**

silver



---

**Colour temperature**

3000K / 4000K





**LED-GLASER-SOL100C**

8031414917082  
FANEU00006286  
lumen

colour temp.	colour
1200 lm	

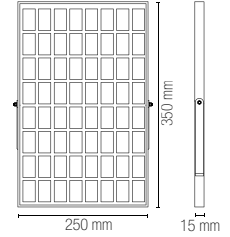
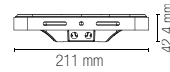
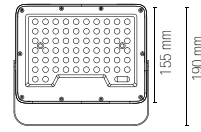

**LED-GLASER-SOL100M**

8031414917075  
FANEU00006287  
lumen

colour temp.	colour
1200 lm	

beam angle 120°



Extension cable  
Solar panel connection /  
Verlängerungskabel  
Solarpanel-Anschluss



**LED-GLASER-SOL200C**

8031414917099  
FANEU00006288  
lumen

colour temp.	colour
1800 lm	

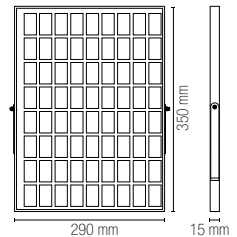
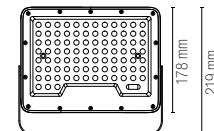

**LED-GLASER-SOL200M**

8031414917105  
FANEU00006289  
lumen

colour temp.	colour
1800 lm	

beam angle 120°



Extension cable  
Solar panel connection /  
Verlängerungskabel  
Solarpanel-Anschluss



**LED-GLASER-SOL400C**

8031414917129  
FANEU00006290  
lumen

colour temp.	colour
3500 lm	

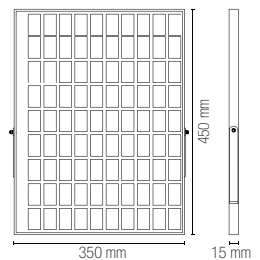
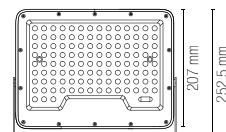

**LED-GLASER-SOL400M**

8031414917112  
FANEU00006291  
lumen

colour temp.	colour
3500 lm	

beam angle 120°



Extension cable  
Solar panel connection /  
Verlängerungskabel  
Solarpanel-Anschluss

Enthaltenes Zubehör / Accessories included



**Li-ion 3.2V 15Ah**  
Batterie nicht ersetzbar /  
Battery not replaceable



Batterie nicht ersetzbar /  
Battery not replaceable

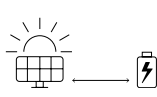

Solarpanel /  
Solar panel



Fernbedienung /  
Remote control

Nicht enthaltene Zubehör / Accessory not included

**LED-GLASER-CABLE**

8031414917136  
FANEU00006279

2 m Kabel für Solarpanel mit  
Stecker-/Buchsenanschluss /  
2 m extension cable for solar  
panel with male/female extend

# LUXOR





**Material**  
PC

**Farbe**  
Anthrazit



**Farbtemperatur**  
3000K / 4000K



**Material**  
PC

**Colour**  
anthracite



**Colour temperature**  
3000K / 4000K



Im Farbton Anthrazit, eine praktische solarbetriebene Laterne, die als Wandleuchte oder oben auf einem Pfahl installiert werden kann. Ausgestattet mit einem leistungsstarken Akku garantiert es eine optimale Akkulaufzeit Lichtausbeute dank Bewegungs- und Dämmerungssensor.

A practical solar street light with anthracite finish, which can be installed as a wall light or mounted on a pole. Supplied with a powerful rechargeable battery, it guarantees optimal battery life light output thanks to the motion and twilight sensor.



Mastbefestigungswinkel, Eingangsdurchmesser: min. 40 mm - max. 80 mm / Pole mounting bracket, entry diameter min. 40mm - max 80mm

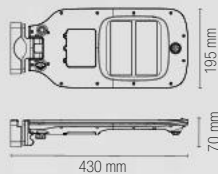

	colour temp.	colour
<b>LED-LUXOR-6C-SOLAR</b> 8031414921898 FANEU00006736 lumen		
	600 lm	
<b>LED-LUXOR-6M-SOLAR</b> 8031414921904 FANEU00006737 lumen		
	600 lm	
watt	6,5W	
beam angle	90° x 110°	

**Enthaltenes Zubehör / Accessories included**



Solarpanel / Solar panel



**Li-ion 3.7V 5.4AH**  
Batterie nicht ersetzbar / Battery not replaceable



**Schalter für zwei Funktionen / Switch for two functions**

1. Dämmerungssensor ON 100 % Licht für 10 min  
Nach 2 Stunden allmähliche Reduzierung bis auf 10 % Licht / Crepuscular sensor ON 100% light for 10 min  
After 2 hours gradual reduction to 10% light
2. Bewegungssensor ON 100 % Licht  
Nach 20 Sekunden 20 % Licht / Motion sensor ON 100% light  
After 20 seconds 20% light





**Flutlichtleuchten / Flood lights**  
outdoor

# BANNER





**Flutlichtleuchte aus schwarzem Metall mit satiniertem Finish. Die Struktur ist flexibel, mit vertikal bis zu 45° und horizontal bis zu 340° verstellbarem Lichtpunkt. Bietet Schutz vor Staub und Wasserstrahlen aus allen Richtungen und einen G10-Sockel.**  
 Spotlight in black metal with satin finish. Its structure is flexible with a light point that can be adjusted vertically up to 45°, and horizontally up to 340°. It provides protection against dust and water jets from all directions, and has a GU10 fitting.

**Material**

Metall

**Farbe**

Satiniertes Schwarz



**Material**

metal

**Colour**

satin black



Glühbirne nicht enthalten / Light bulb not included

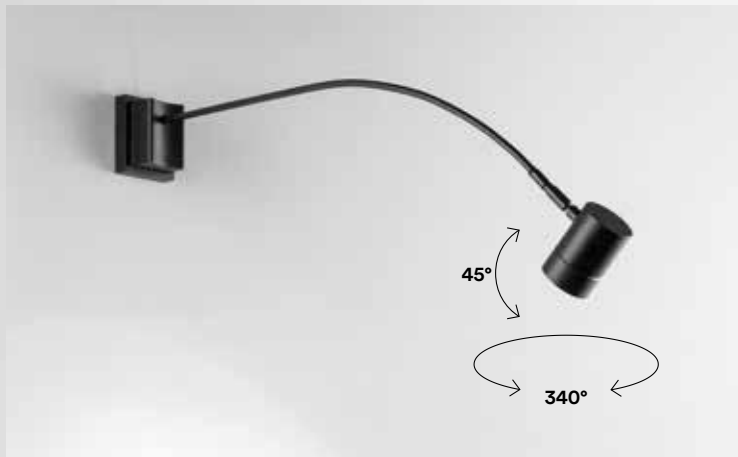

**I-BANNER-AP**  
 8031414883004  
 FANEU00001246

colour



1 x GU10 MAX 35W

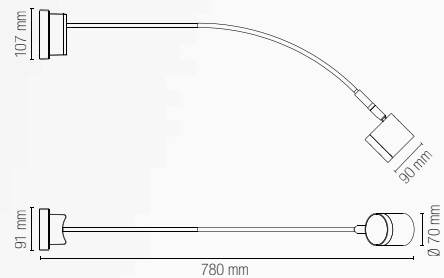

# SAT



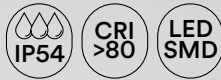

**Material**  
Thermoplast

**Farbe**  
Anthrazit



**Farbtemperatur**  
4000K



**Driver**  
eingebaut

**Material**  
thermoplastic

**Colour**  
anthracite



**Colour temperature**  
4000K



**Driver**  
included

**Flutlichtleuchte aus Thermoplast mit neigbarem einzeltem oder doppeltem Lichtpunkt. Die Beleuchtung erfolgt mit integrierter LED und die Ausstattung umfasst auch einen einstellbaren Dämmerungs- und Bewegungssensor.**  
Floodlight in thermoplastic with adjustable single or dual light point. Integrated LED lighting, also supplied with a twilight sensor and an adjustable motion sensor.



	colour temp.	colour
<b>LED-SAT-10</b> 8031414868261 FANEU00007335 lumen		
	1200 lm	
watt	10W	
beam angle	120°	

	colour temp.	colour
<b>LED-SAT-20</b> 8031414868278 FANEU00007336 lumen		
	2400 lm	
watt	2 x 10W	
beam angle	120°	

**Enthaltenes Zubehör / Accessories included**

Regulierbarer Bewegungssensor / Adjustable motion sensor

3-8m  
360°

10<sup>sec</sup> - 10<sup>min</sup>

off  
on

3-2000 LUX

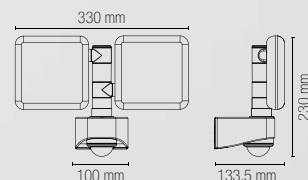
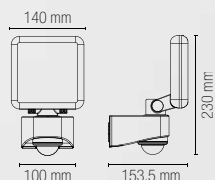

# ESUS

Kollektion von LED-Flutlichtleuchten mit Diffusor aus Acryl und Gehäuse aus Aluminium mit weißem oder silberfarbenem Finish. Erhältlich in zahlreichen Größen, kann mit warmem, neutralem oder natürlich kaltem Lichtfarbton installiert werden.

A collection of LED floodlights with acrylic diffuser and aluminium fixture with a white or silver finish. Available in many sizes, it can be installed with a natural warm, neutral or cool colour temperature.

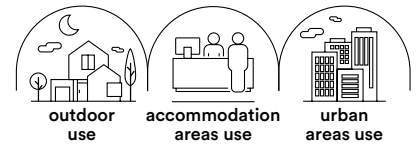

---

#### Material

Aluminium,  
Diffusor Acryl

---

#### Farbe

Weiß  
Silber



---

#### Farbtemperatur

3000K / 4000K / 6500K



---

#### Driver

eingebaut

---

#### Material

aluminium  
acrylic diffuser

---

#### Colour

white  
silver



---

#### Colour temperature

3000K / 4000K / 6500K



---

#### Driver

built-in

---



ESUS





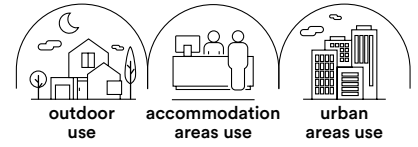

In.tec light FLUTLICHTLEUCHTEN / FLOOD LIGHTS



**LED-ESUS-10-BCO**

8031414930449  
FANEU00025901

lumen

colour temp.	colour
	
	
1000 lm	

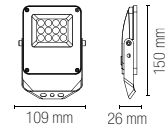





watt	10W
beam angle	110°
pf	-



**LED-ESUS-20-BCO**

8031414930456  
FANEU00025902

lumen

colour temp.	colour
	
	
2000 lm	

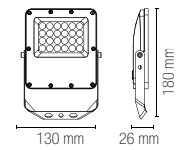





watt	20W
beam angle	110°
pf	-



**LED-ESUS-50-BCO**

8031414930463  
FANEU00025903

lumen

colour temp.	colour
	
	
5000 lm	

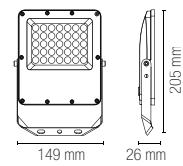

watt	50W
beam angle	110°
pf	0.90

**Photometrie des Produkts / Photometric curve**

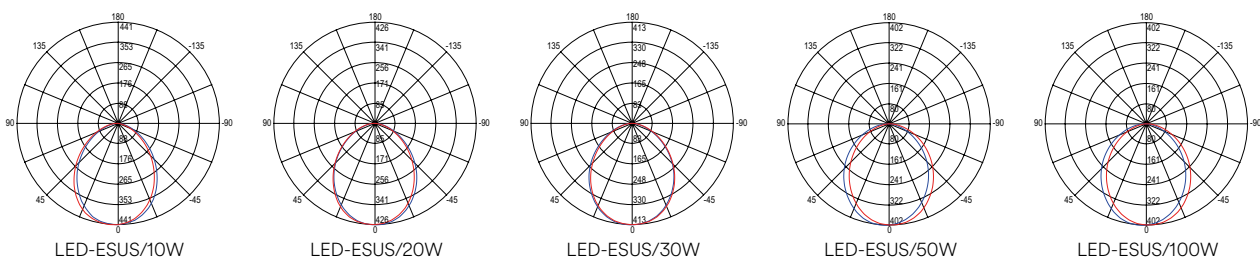



**LED-ESUS-10**  
8031414927845  
FANEU00025696  
lumen

colour temp.	colour

1000 lm

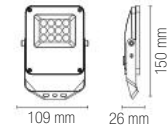

watt	10W
beam angle	110°
pf	-



**LED-ESUS-20**  
8031414927869  
FANEU00025693  
lumen

colour temp.	colour

2000 lm

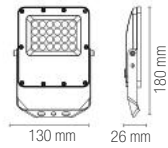

watt	20W
beam angle	110°
pf	-



**LED-ESUS-30**  
8031414927883  
FANEU00025695  
lumen

colour temp.	colour

3000 lm

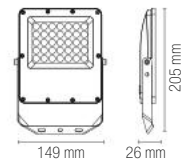

watt	30W
beam angle	110°
pf	0.90



**LED-ESUS-50**  
8031414927906  
FANEU00025700  
lumen

colour temp.	colour

5000 lm



watt	50W
beam angle	110°
pf	0.90



**LED-ESUS-100**  
8031414927913  
FANEU00025904  
lumen

colour temp.	colour

10000 lm

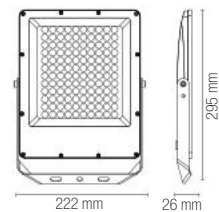

watt	100W
beam angle	110°
pf	0.90

# ESUS SENSOR



LED-Flutlichtleuchte aus weißem oder silbernem Aluminium mit konfigurierbarem Bewegungssensor. Mit drei auswählbaren Farbtemperaturen garantiert er hervorragende Leistungen in Hinblick auf Stoßfestigkeit sowie Schutz gegen Staub und Flüssigkeiten und hohe Farbtreue.

LED floodlight in aluminium with white or silver finish, with configurable motion sensor. With three selectable colour temperatures, it ensures excellent impact resistance, protection against dust and liquids and high colour fidelity.

- Material**  
Aluminium

---

- Farbe**  
Silber

---

- Farbtemperatur**  
3000K / 4000K / 6500K

---

- Driver**  
eingebaut

---

- Material**  
aluminium

---

- Colour**  
silver

---

- Colour temperature**  
3000K / 4000K / 6500K

---

- Driver**  
built-in



## Enthaltenes Zubehör / Accessories included

Regulierbarer Bewegungssensor / Adjustable motion sensor



**LED-ESUS-S10**  
8031414927852  
FANEU00026612  
lumen

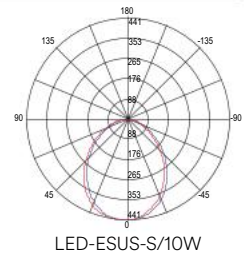
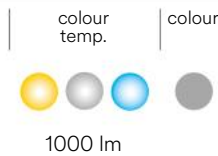

watt 10W  
beam angle 110°

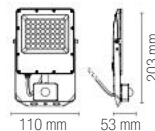

## Enthaltenes Zubehör / Accessories included

Regulierbarer Bewegungssensor / Adjustable motion sensor



**LED-ESUS-S30**  
8031414927890  
FANEU00026613  
lumen

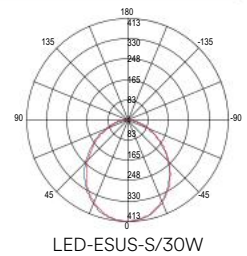

watt 30W  
beam angle 110°

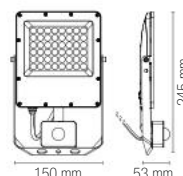

# ESUS PORTABLE



Tragbare LED-Flutlichtleuchte in silbernem Finish. Ein echter Arbeitskamerad, dank des hohen Grads an Stoßfestigkeit, Schutz vor Staub und Wasserstrahlen, hohem Sehkomfort und auf 3 Temperaturen verstellbarer Helligkeit.

Portable LED floodlight with silver finish. A true work companion with its high impact resistance, protection against dust and water jets, high visual comfort and brightness adjustable to 3 colour temperatures.

**Material**

Aluminium

**Farbe**

Silber



**Farbtemperatur**

3000K / 4000K / 6500K



**Driver**

eingebaut

**Material**

aluminium

**Colour**

silver



**Colour temperature**

3000K / 4000K / 6500K



**Driver**

built-in

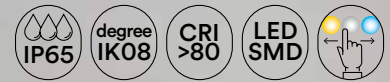

**Enthaltenes Zubehör / Accessories included**

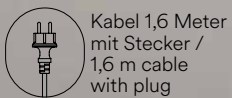

Kabel 1,6 Meter mit Stecker / 1,6 m cable with plug

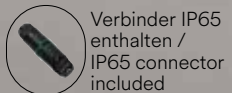

Verbinder IP65 enthalten / IP65 connector included

**LED-ESUS-P30**  
8031414927876  
FANEU00025699  
lumen



3000 lm

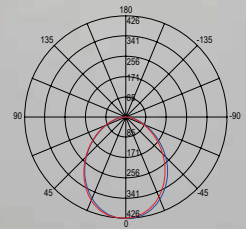

LED-ESUS-P/30W

watt 30W  
beam angle 110°

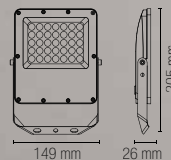

# AXEL

Flutlichtleuchte mit integrierter LED und Diffusor aus Acryl sowie Metallgehäuse mit geprägten Finishs in Weiß oder Silber. Erhältlich in unterschiedlichen Formaten, bietet Einstellung mit CCT, hohe Farbwiedergabe und Schutz vor Staub und Flüssigkeiten.

Floodlight with integrated LED, acrylic diffuser and metal fixture with white or silver embossed finish. Available in various sizes, it provides adjustable CCT, high colour rendering and protection against dust and liquids.



## Material

Aluminium,  
Diffusor Acryl

## Farbe

Weiß, geprägt  
Silber, geprägt



## Farbtemperatur

3000K / 4000K



CCT



## Driver

eingebaut

## Material

aluminium  
acrylic diffuser

## Colour

embossed white  
embossed silver



## Colour temperature

3000K / 4000K



CCT



## Driver

built-in



AXEL













In.tec light

FLUTLICHTLEUCHTEN / FLOOD LIGHTS

# AXEL



		<b>LED-AXEL-10-BCO</b> 8031414918744 FANEU00005816 lumen	colour temp.   1100 lm	colour 	 117 mm  137 mm 38 mm
		<b>LED-AXEL-10-SIL</b> 8031414918676 FANEU00005817 lumen	colour temp.   1100 lm	colour 	
		watt	10W		
		beam angle	100°		
		pf	-		

		<b>LED-AXEL-20-BCO</b> 8031414918751 FANEU00005818 lumen	colour temp.   2200 lm	colour 	 137 mm  158 mm 36 mm
		<b>LED-AXEL-20-SIL</b> 8031414918683 FANEU00005819 lumen	colour temp.   2200 lm	colour 	
		watt	20W		
		beam angle	100°		
		pf	-		

		<b>LED-AXEL-50-BCO</b> 8031414918768 FANEU00005821 lumen	colour temp.   5500 lm	colour 	 228 mm  301 mm 38 mm
		<b>LED-AXEL-50-SIL</b> 8031414918706 FANEU00005822 lumen	colour temp.   5500 lm	colour 	
		watt	50W		
		beam angle	100°		
		pf	0.90		



CCT

**LED-AXEL-30-SIL**

8031414918690  
FANEU00005820  
lumen

colour temp.	colour
3300 lm	

watt	30W
beam angle	100°
pf	0.90

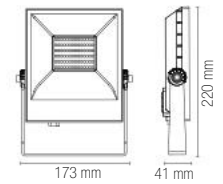

degree IK09 CCT

**LED-AXEL-100-SIL**

8031414951574  
FANEU00028791  
lumen

colour temp.	colour
13650 lm	

watt	100W
beam angle	100°
pf	0.95

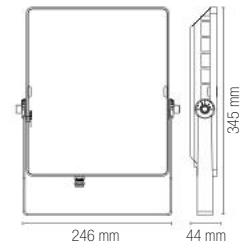

**LED-AXEL-150-SIL**

8031414951581  
FANEU00028792  
lumen

colour temp.	colour
20475 lm	

watt	150W
beam angle	100°
pf	0.95

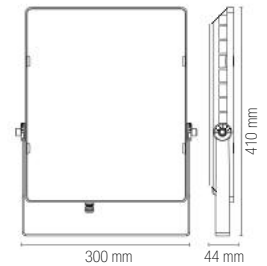

**LED-AXEL-200-SIL**

8031414951598  
FANEU00028793  
lumen

colour temp.	colour
27300 lm	

watt	200W
beam angle	100°
pf	0.95

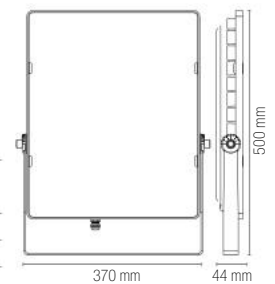

# AXEL SENSOR

Flutlichtleuchte aus Aluminium mit geprägtem silbernem Finish. Die Flutlichtleuchte mit integrierter LED ist für größte Zweckmäßigkeit und Energieeinsparung mit einstellbarem Bewegungs- und Dämmerungssensor ausgestattet.

Floodlight in aluminium with silver embossed finish. With integrated LED, the floodlight is supplied with a motion sensor and adjustable twilight sensor for maximum practicality and energy saving.



**Material**

Aluminium

**Farbe**

Silber, geprägt

**Farbtemperatur**

3000K / 4000K



**Driver**

eingebaut

**Material**

aluminium

**Colour**

embossed silver

**Colour temperature**

3000K / 4000K



**Driver**

built-in



**Enthaltenes Zubehör / Accessories included**

Regulierbarer Bewegungssensor / Adjustable motion sensor



**LED-AXEL-S10-SIL**

8031414918713  
FANEU00005824  
lumen

colour temp.



1100 lm

colour

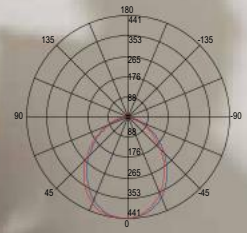

LED-AXEL-S/10W

watt 10W  
beam angle 110°



**Enthaltenes Zubehör / Accessories included**

Regulierbarer Bewegungssensor / Adjustable motion sensor



**LED-AXEL-S30-SIL**

8031414918737  
FANEU00005825  
lumen

colour temp.



3300 lm

colour

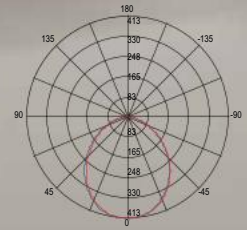

LED-AXEL-S/30W

watt 30W  
beam angle 110°

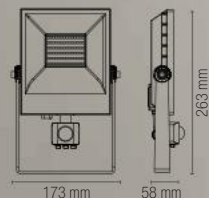

# AXEL PORTABLE

Tragbare, zweifarbige (gelb und schwarz) LED-Flutlichtleuchte mit technischen Spezifikationen auf hohem Niveau für den Schutz vor Staub und Wasserstrahlen, CCT-Einstellung mit zwei Farbtemperaturen und hohem Farbwiedergabeindex. Portable LED floodlight with dual colour – yellow and black – with high technical specifications for protection against dust and water jets, dual CCT adjustment and high colour rendering.



**Material**  
Aluminium

**Farbe**  
Gelb/Schwarz



**Farbtemperatur**  
3000K / 4000K



**Driver**  
eingebaut

**Material**  
aluminium

**Colour**  
yellow/black



**Colour temperature**  
3000K / 4000K



**Driver**  
built-in



FLUTLICHTLEUCHTEN / FLOOD LIGHTS  
In.tec light



**Enthaltenes Zubehör / Accessories included**

 Kabel 1,6 Meter mit Stecker / 1,6 m cable with plug



**LED-AXEL-P20-NER**  
8031414918720  
FANEU00005823  
lumen

colour temp.    
2200 lm

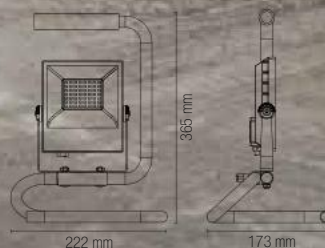
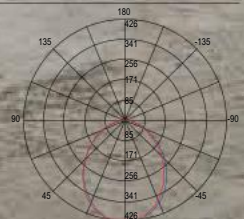

**LED-AXEL-P/20W**  
watt 20W  
beam angle 110°

# BULL





**Eine Kollektion von tragbaren, batteriebetriebenen Arbeitsflutlichtleuchten in zwei Größen und in der Version mit eingebauten Bluetooth-Lautsprecher. Die Beleuchtung mit der Farbtemperatur von Tageslicht erfolgt mittels Touch-Schalter mit 3 Helligkeitsstufen.**

A collection of battery-powered portable work floodlights, available in two sizes and in a version with integrated Bluetooth speaker. Daylight lighting with a touch switch offering 3 brightness settings.

**Material**  
Kunststoff

**Farbe**  
Gelb/Schwarz



**Farbtemperatur**  
6500K



**Driver**  
eingebaut

**Material**  
plastic

**Colour**  
yellow/black



**Colour temperature**  
4000K



**Driver**  
built-in



**LED-BULL-15DJ**  
8031414917167  
FANEU00026866  
lumen

colour temp.	colour
1200 lm	

watt	15W
beam angle	90°
switch DIMMER	25% 50% 70% 100% OFF

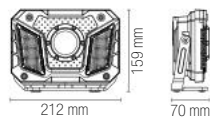

**LED-BULL-10**  
8031414917150  
FANEU00026722  
lumen

colour temp.	colour
1000 lm	

watt	10W
beam angle	90°
switch DIMMER	25% 50% 70% 100% OFF

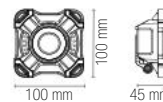

**SPEAKER**  
2x5 W Bluetooth-Verbindung 4.2 max. 10 m /  
2x5W bluetooth 4.2 connection max 10m

**Enthaltenes Zubehör / Accessories included**

**USB**  
Ladekabel 60 cm /  
60 cm charging cable

**4 hours**  
**3.7V/6600 mAh**  
Aufladbare Batterie, nicht ersetzbar /  
Rechargeable battery, not replaceable

**Enthaltenes Zubehör / Accessories included**

**USB**  
Ladekabel 60 cm /  
60 cm charging cable

**2 hours**  
**3.7V/2200 mAh**  
Aufladbare Batterie, nicht ersetzbar /  
Rechargeable battery, not replaceable

Adapter nicht enthalten /  
Adaptor not included

# KNOX





**Knox ist aus widerstandsfähigem Kunststoff und Aluminium hergestellt und eine Flutlichtleuchte mit auswählbarer Temperatur und doppeltem Schuko-Anschluss für größte Zweckmäßigkeit. Garantiert optimale Sicht und IP-Schutz vor Flüssigkeiten und Staub.**

Made of durable plastic and aluminium, Knox is a floodlight with selectable temperature and two rear Schuko sockets for maximum ease of use. It ensures optimum visibility and IP protection against liquids and dust.

**Material**  
Kunststoff

**Farbe**  
Gelb/Schwarz



**Farbtemperatur**

6500K



**Driver**  
eingebaut

**Material**  
plastic

**Colour**  
yellow/black



**Colour temperature**

6500K



**Driver**  
built-in



**LED-KNOX-45**

8031414917174  
FANEU00026868  
lumen

colour temp. colour



max 6400 lm

watt 45W  
beam angle 120°

Plug 2X max 15A 250V 2500W IP54

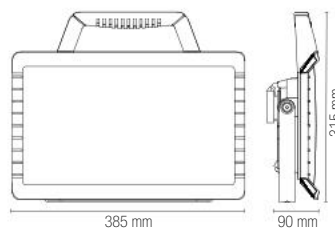

**Enthaltenes Zubehör / Accessory included**



Kabel 3 Meter mit Stecker / 3 m cable with plug

IP44

FLUTLICHTLEUCHTEN / FLOOD LIGHTS

In.tec light



**LED-KNOX-80**

8031414917181  
FANEU00026870  
lumen

colour temp. colour



max 11500 lm

watt 80W  
beam angle 120°

Plug 2X max 15A 250V 2500W IP54

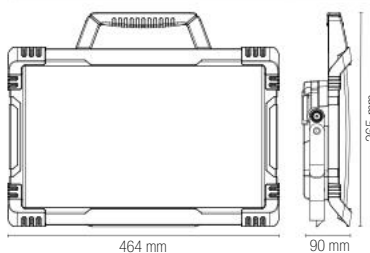

**Enthaltenes Zubehör / Accessory included**



Kabel 3 Meter mit Stecker / 3 m cable with plug

IP44

Helligkeitseinstellschalter / Brightness adjustment switch



# ATHOS

Flutlichtleuchte mit integrierter LED, satiniertem Diffusor und Gehäuse aus Aluminium in silbernem Finish. In drei Größen erhältlich, sichert höchste Leistungen durch Stoßfestigkeit und hohen IP-Schutz gegen Staub und Wasserstrahlen.

Floodlight with integrated LED, satin diffuser and aluminium fixture with silver finish. Available in three sizes, it ensures the highest performance in terms of impact resistance, and high IP protection against dust and water jets.



**Material**  
Aluminium

**Farbe**  
Silber



**Farbtemperatur**  
4000K / 6000K



**Driver**  
eingebaut

**Material**  
aluminium

**Colour**  
silver



**Colour temperature**  
4000K / 6000K



**Driver**  
built-in





**LED-ATHOS-100**  
8031414884186  
FANEU00005776  
lumen

colour temp.	colour
10115 lm	

**LED-ATHOS-100F**  
8031414884193  
FANEU00005777  
lumen

colour temp.	colour
9624 lm	

watt	100W
beam angle	120°
pf	0.90

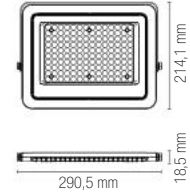

**LED-ATHOS-150**  
8031414884209  
FANEU00005778  
lumen

colour temp.	colour
14557 lm	

**LED-ATHOS-150F**  
8031414884216  
FANEU00005779  
lumen

colour temp.	colour
14388 lm	

watt	150W
beam angle	120°
pf	0.90

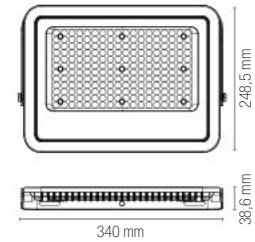

**LED-ATHOS-200**  
8031414884223  
FANEU00005780  
lumen

colour temp.	colour
20371 lm	

**LED-ATHOS-200F**  
8031414884230  
FANEU00005781  
lumen

colour temp.	colour
20310 lm	

watt	200W
beam angle	120°
pf	0.90

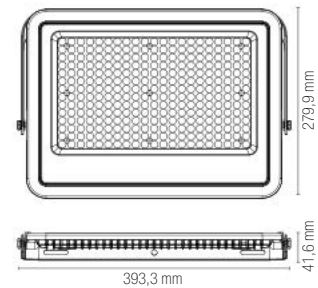

Photometrie des Produkts / Photometric curve

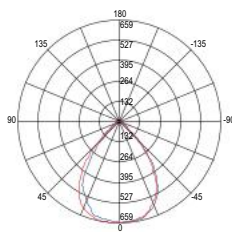

LED-ATHOS-100

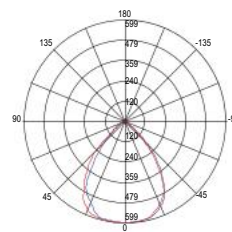

LED-ATHOS-150

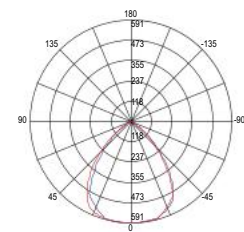

LED-ATHOS-200





**I-TRIPOD**

8031440361729  
FANEU00003852

Zubehör für  
Flutlichtleuchten  
Befestigungssystem  
einzeln und doppelt

Flood light accessories  
Single and double  
connection system

**Enthaltenes Zubehör /  
Accessories included**



Kabel 2,8 Meter  
mit Stecker /  
2,8 m cable  
with plug

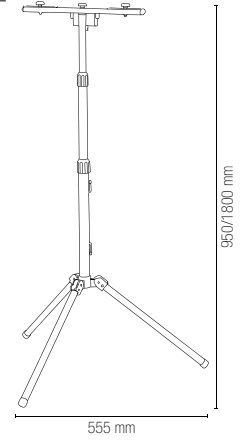

**I-SPIKE-ANT**

8031414877973  
FANEU00003679

Anthrazitfarbener  
Aluminiumpflock

Anthracite aluminum  
spike

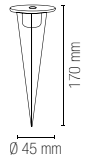

# GIOVE

Flutlichtleuchte mit integrierter LED und Struktur aus Aluminiumdruckguss sowie Diffusor aus Hartglas. Erhältlich in verschiedenen Größen bietet die Möglichkeit der Auswahl verschiedener Farbtemperaturen oder von rotem und grünem Licht.

Floodlight with integrated LED, die-cast aluminium fixture and tempered glass diffuser. Available in various sizes, it allows you to select different colour temperatures or red and green light.



## Material

Aluminium

## Farbe

Schwarz



## Farbtemperatur

3000K / 4000K / 6000K / RED / GREEN



## Driver

inklusive

## Lebensdauer und on/off

50.000 h  
>25.000 on/off

## Material

aluminium

## Colour

black



## Colour temperature

3000K / 4000K / 6000K / RED / GREEN



## Driver

included

## Life time and on/off

50.000 h  
>25.000 on/off



GIOVE



In.tec light FLUTLICHTLEUCHTEN / FLOOD LIGHTS



**LED-GIOVE-100**  
8031414882557  
FANEU00006266  
lumen

colour temp.	beam angle	colour
	150° x 80°	

watt	100W
pf	0.90

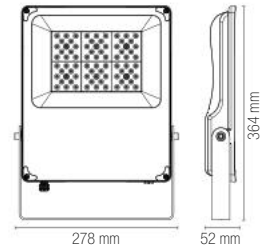

**LED-GIOVE-300**  
8031414876372  
FANEU00006274  
lumen

colour temp.	beam angle	colour
	150° x 80°	

watt	300W
pf	0.90

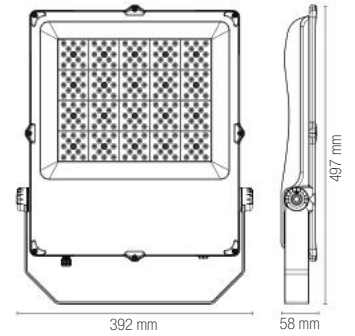

**LED-GIOVE-400**  
8031414876389  
FANEU00006275  
lumen

colour temp.	beam angle	colour
	150° x 80°	

watt	400W
pf	0.90

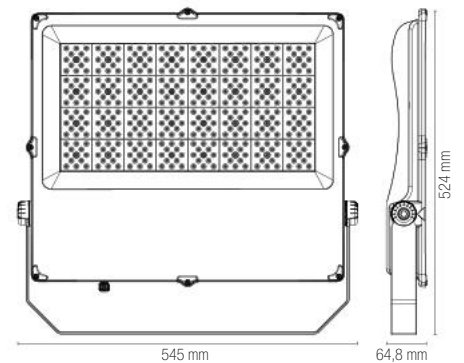



	colour temp.	beam angle	colour		colour temp.	beam angle	colour
<b>LED-GIOVE-200</b> 8031414876365 FANEU00006267 lumen	32666 lm	150° x 80°		<b>LED-GIOVE-200C</b> 8031414934553 FANEU00026032 lumen	32000 lm	150° x 80°	
<b>LED-GIOVE-200-30</b> 8031414885138 FANEU00006268 lumen	32666 lm	30°		<b>LED-GIOVE-200M</b> 8031414934560 FANEU00026033 lumen	32000 lm	150° x 80°	
<b>LED-GIOVE-200-60</b> 8031414885145 FANEU00006269 lumen	32666 lm	60°		<b>LED-GIOVE-200C-30</b> 8031414934577 FANEU00026034 lumen	32000 lm	30°	
<b>LED-GIOVE-200R-30</b> 8031414885152 FANEU00006270 lumen	RED	30°		<b>LED-GIOVE-200M-30</b> 8031414934591 FANEU00026036 lumen	32000 lm	30°	
<b>LED-GIOVE-200R-60</b> 8031414885169 FANEU00006271 lumen	RED	60°		<b>LED-GIOVE-200C-60</b> 8031414934584 FANEU00026035 lumen	32000 lm	60°	
<b>LED-GIOVE-200V-30</b> 8031414885176 FANEU00006272 lumen	GREEN	30°		<b>LED-GIOVE-200M-60</b> 8031414934607 FANEU00026037 lumen	32000 lm	60°	
<b>LED-GIOVE-200V-60</b> 8031414885183 FANEU00006273 lumen	GREEN	60°					
watt				watt			
pf	200W 0.90			pf	200W 0.90		

FLUTLICHTLEUCHTEN / FLOOD LIGHTS

In.tec light

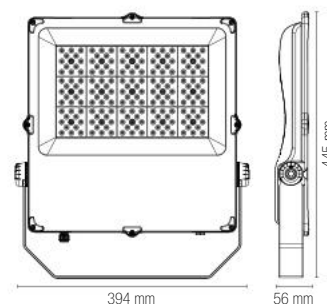

Photometrie des Produkts / Photometric curve



# MASTER





**Material**  
Aluminium

**Farbe**  
Schwarz



**Farbtemperatur**  
5700K



**Driver**  
inklusive

**Lebensdauer und on/off**  
50.000 h  
>25.000 on/off

**Material**  
aluminium

**Colour**  
black



**Colour temperature**  
5700K



**Driver**  
included

**Life time and on/off**  
50.000 h  
>25.000 on/off

**Flutlichtleuchte mit integrierter LED und Struktur aus Aluminiumdruckguss sowie Diffusor mit Linsen aus selbstlöschendem, stoßfestem und UV-beständigem Material. Mit IK-Index auf höchstem Niveau garantiert sie einen hohen Schutz vor Flüssigkeiten und Staub.**

Floodlight with integrated LED with die-cast aluminium fixture and diffuser and lenses made of self-extinguishing, impact-resistant and UV-resistant material. With the highest IK rating, it ensures high protection against liquids and dust.

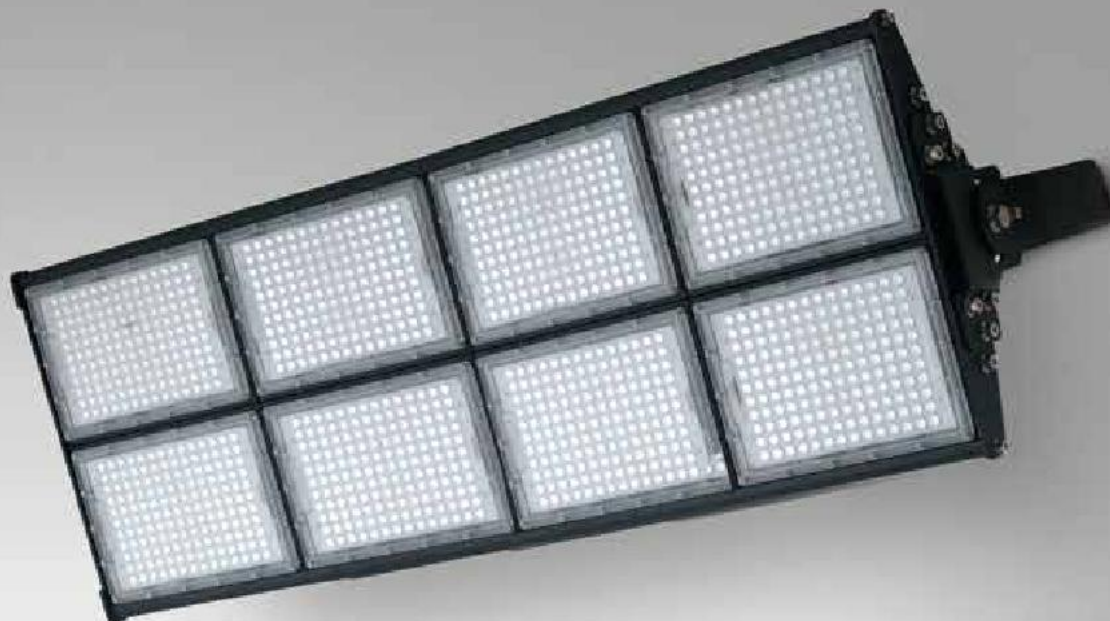

FLUTLICHTLEUCHTEN / FLOOD LIGHTS

In.tec light

**LED-MASTER-960**

8031414862122  
FANEU00006755

lumen

colour temp.	colour
129600 lm	

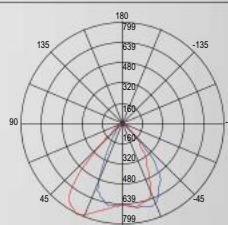

LED-MASTER-960

watt	960W
beam angle	60° x 100°
pf	0.90

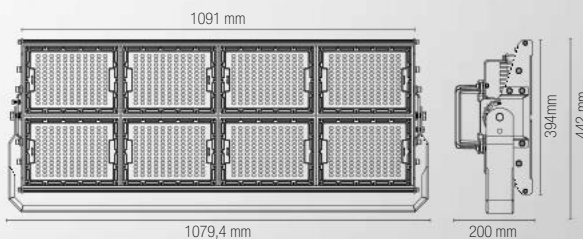

# ENERGY

Eingebauter LED-Strahler für Überdachung, Struktur aus Aluminiumdruckguss und Diffusor mit Linsen aus selbstlöschendem, schlagfestem, UV-beständigem Material.

Gas station built-in LED light in die-cast aluminium body and lens in anti-UV, self-extinguishing, shockproof material.



**Material**  
Aluminium

**Material**  
aluminium

**Farbe**  
Weiß

**Colour**  
white



**Farbtemperatur**  
4000K

**Colour temperature**  
4000K



**Driver**  
inklusive

**Driver**  
included

**Lebensdauer und on/off**  
50.000 h  
>25.000 on/off

**Life time and on/off**  
50.000 h  
>25.000 on/off

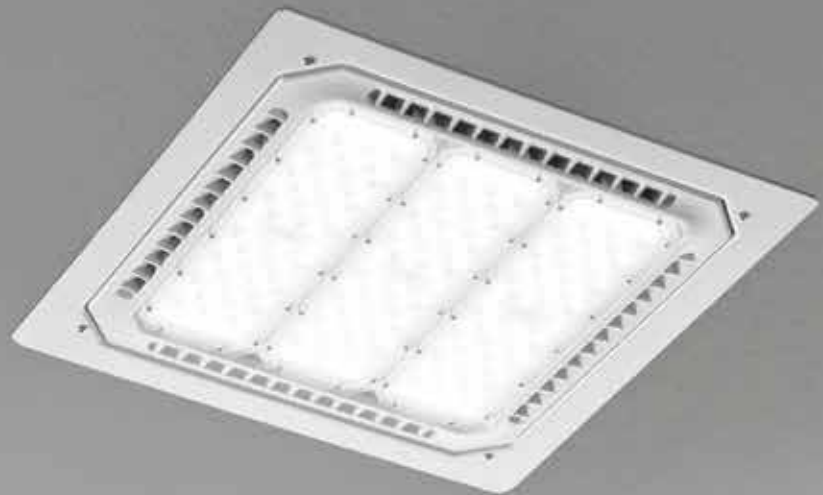



ENERGY



**LED-ENERGY-80-INC**

8031414862085  
FANEU00006152  
lumen

colour temp.	colour
11100 lm	

watt	80W
beam angle	80°
pf	0.90

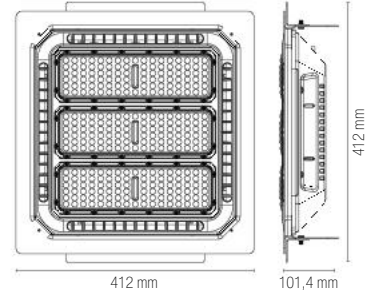

**LED-ENERGY-80-PL**

8031414862078  
FANEU00006153  
lumen

colour temp.	colour
11100 lm	

watt	80W
beam angle	80°
pf	0.90

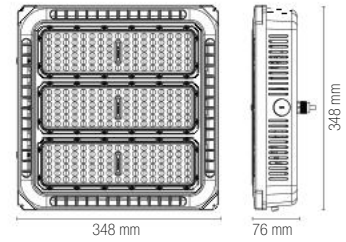

Photometrie des Produkts / Photometric curve

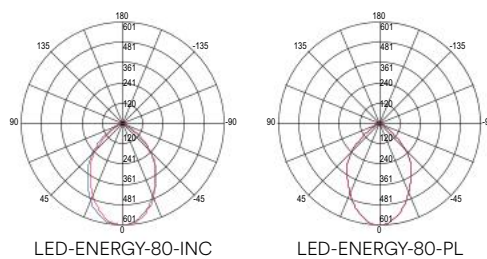





**Strassenlampen / Street lights**  
outdoor

# AUREUS

**LED-Straßenleuchte aus Aluminium mit anthrazitfarbenem Finish und integriertem Solarpanel. Mit Fernbedienung, Dämmerungs- und Bewegungssensor mit Einstellung des Lichtstroms für höchste Energieeffizienz.**

LED street light in aluminium with anthracite finish and integrated solar panel. With remote control, twilight sensor and motion sensor with luminous flux adjustment, for maximum energy efficiency.





**Material**  
Aluminium

**Farbe**  
Anthrazit



**Farbtemperatur**  
3000K / 4000K



**Driver**  
inklusive

**Material**  
aluminum

**Colour**  
anthracite



**Colour temperature**  
3000K / 4000K



**Driver**  
included



**LED-AUREUS-20C-SOLAR**

8031414921874  
FANEU00005798  
lumen

colour temp. colour



1600 lm

**LED-AUREUS-20M-SOLAR**

8031414921881  
FANEU00005799  
lumen



1600 lm

watt 20W  
beam angle 80° x 80°

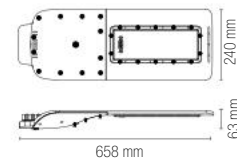

**Enthaltenes Zubehör / Included accessories**

Solarpanel /  
Solar panel

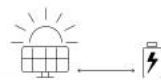

**3.2V 20Ah LiFePO4**  
Auffadbare Batterie, nicht ersetzbar /  
Rechargeable battery not replaceable



Fernbedienung /  
Remote control



**Schalter für zwei Funktionen / Switch for two functions**

1. Dämmerungssensor ON 100 %  
Licht für 10 min  
Nach 2 Stunden allmähliche  
Reduzierung bis auf 10 % Licht /  
Crepuscular sensor ON 100%  
light for 10 min  
After 2 hours gradual  
reduction to 10% light

2. Bewegungssensor ON 100 % Licht  
Nach 20 Sekunden 20 % Licht /  
Motion sensor ON 100% light  
After 20 seconds 20% light

# RADIUS

LED-Straßenleuchte aus silbernem Aluminium mit Solarpanel und Bewegungs- und Dämmerungssensor. Erhältlich in zwei Größen und mit zwei Leistungen, kann standortfernen Steuerung mit Fernbedienung ausgestattet werden.

LED street light in aluminium with silver finish, with solar panel, motion sensor and twilight sensor. Available in two sizes and luminous outputs, it can be fitted with radio remote control for remote operation.



**Material**  
Aluminium

**Farbe**  
Silber



**Farbtemperatur**  
3000K / 4000K



**Driver**  
inklusive

**Material**  
aluminum

**Colour**  
silver



**Colour temperature**  
3000K / 4000K



**Driver**  
included

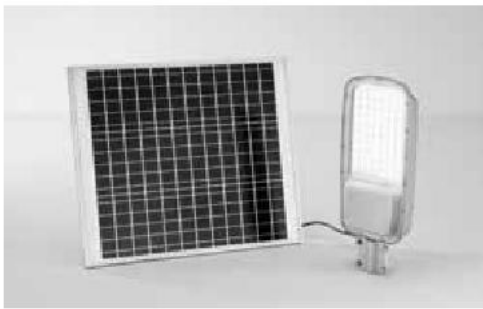

**LED-RADIUS-15C-SOLAR**

8031414917006  
FANEU00007180

lumen

colour temp. colour



2100 lm

**LED-RADIUS-15M-SOLAR**

8031414917013  
FANEU00007181

lumen

2100 lm

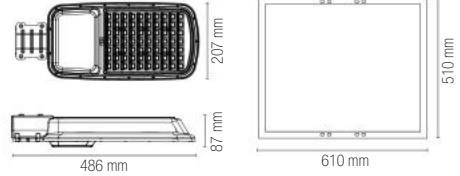

watt 15W  
beam angle 80° x 140°  
pf 0.90



**LED-RADIUS-30C-SOLAR**

8031414917020  
FANEU00007182

lumen

colour temp. colour



4200 lm

**LED-RADIUS-30M-SOLAR**

8031414917037  
FANEU00007183

lumen

4200 lm

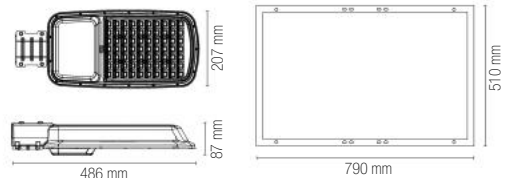

watt 30W  
beam angle 80° x 140°  
pf 0.90

Pfahleintritt 60 mm /  
60 mm pole entry

**Nicht enthaltene Zubehör / Accessories not included**



**LED-RADIUS-ST**

8031414917044  
FANEU00007185

Halterung für Montage auf Pfahl /  
Pole mounting bracket

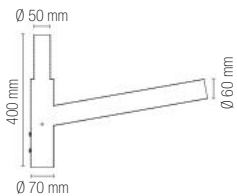

**LED-RADIUS-ST-W**

8031414917051  
FANEU00007186

Halterung für Montage auf Pfahl und an Mauer /  
Pole or wall mounting bracket

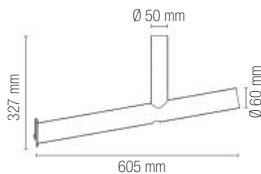

**Enthaltenes Zubehör / Included accessories**

Solarpanel /  
Solar panel



**15W - 12,8V 12000 mAh**  
**30W - 12,8V 18000 mAh**  
Aufladbare Batterie,  
nicht ersetzbar /  
Rechargeable battery  
not replaceable



**LED-RADIUS-REMOTE**

8031414917068  
FANEU00007184

Fernbedienung / Remote control

**Wichtig:** Für den Betrieb des **LED-RADIUS-SOLAR** ist die Fernbedienung erforderlich (separat erhältlich) / **Important:** The remote control is required to operate the **LED-RADIUS-SOLAR** (sold separately)

**Photometrie des Produkts / Photometric curve**

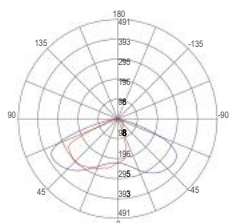

LED-RADIUS-15-SOLAR

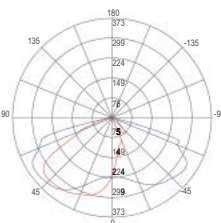

LED-RADIUS-30-SOLAR



Dämmerungssensor ON 80 % Licht  
Nach 20 Sekunden 20 % Licht /  
Crepuscular sensor ON 80% light  
After 20 seconds 20% light

Bewegungssensor ON 80 % Licht  
Nach 20 Sekunden 20 % Licht /  
Motion sensor ON 80% light  
After 20 seconds 20% light

# FEBO



**Material**  
Aluminium

**Material Solarpanel**  
Zellen aus  
einkristallinem Silizium

**Farbe**  
Silber



**Farbtemperatur**  
4000K



**Material**  
aluminum

**Solar panel material**  
monocrystalline  
silicon

**Colour**  
silver



**Colour temperature**  
4000K





**LED-Straßenleuchte aus silbernem Aluminium mit Solarpanel und Linsen aus selbstlöschendem, stoßfestem und UV-beständigem Material. Für größte Funktionalität und Energieeinsparung mit Lichtstrom mit variierbarer Stärke.**

LED street light in aluminium with silver finish, solar panel and lenses in self-extinguishing, impact-resistant and UV-resistant material. With variable luminous flux for maximum functionality and energy saving.

Linsen aus selbstlöschendem, schlagfestem Anti-UV-Material / Lens in anti-UV, self-extinguishing, shockproof material

**LED-FEBO-SOLAR**  
8031414879052  
FANEU00006224  
lumen

colour temp. colour  
6800 lm

watt 40W  
beam angle 140° x 85°

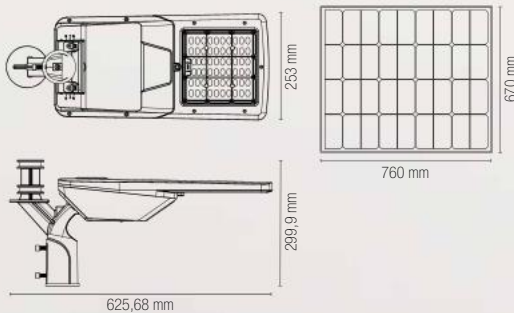

**Enthaltenes Zubehör / Accessories included**

Solarpanel / Solar panel



**Lithium 12,8V 30AH**

Aufladbare Batterie, nicht ersetzbar / Rechargeable battery not replaceable



Pfahleintritt 60 mm / 60 mm pole entry

**Photometrie des Produkts / Photometric curve**

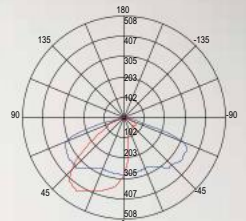

LED-FEBO-SOLAR

flux	on <20lux on off +12h				Werkseitige Settings	Einstellungen / Default	flux
	T1	T2	T3	T4			
100%	Yellow	Yellow	White	White	T1	<20lux ÷ +2h	<b>100%</b>
60%	Yellow	Yellow	White	White	T2	T1 ÷ +2h	<b>60%</b>
50%	Yellow	Yellow	White	White	T3	T2 ÷ +7h	<b>10%</b>
10%	Yellow	Yellow	White	White	T4	T3 ÷ +2h	<b>50%</b>
						+12h off	

# IPERION

Mit Solarenergie betriebene LED-Straßenleuchte aus Aluminium mit silbernem Finish. Bietet einen Mikrowellen-Bewegungs- und Dämmerungssensor und ist mit Linsen aus stoßfestem, selbstlöschendem und UV-beständigem Material ausgestattet.

LED street light with solar panel in aluminium with silver finish. It features a microwave motion sensor and twilight sensor, and lenses in impact-resistant, self-extinguishing and UV-resistant material.



## Material

Aluminium

## Materiale pannello solare

Zellen aus einkristallinem Silizium

## Farbe

Silber



## Farbtemperatur

4000K



## Material

aluminium

## Solar panel material

monocrystalline silicon

## Colour

silver



## Colour temperature

4000K



	colour temp.
<b>LED-IPERION-50-SOLAR</b> 8031414879069 FANEU00006495	9000 lm
lumen	
<b>LED-IPERION-75-SOLAR</b> 8031414879076 FANEU00006496	13500 lm
lumen	
watt	50W
beam angle	156° x 71°

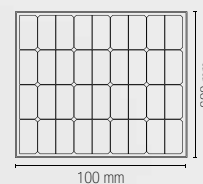
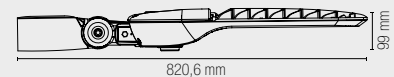
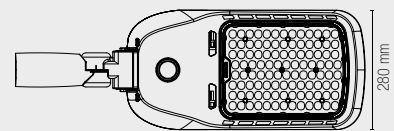

LED-IPERION-50-SOLAR

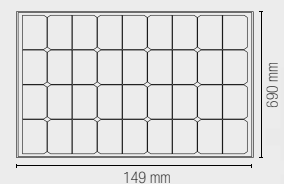

LED-IPERION-75-SOLAR



Linsen aus selbstlöschendem, schlagfestem Anti-UV-Material / Lens in anti-UV, self-extinguishing, shockproof material

**Mikrowellensensor** max. Höhe 6 m, Radius 7 m / **Microwave sensor** max height 6m radius 7m

**Nicht enthaltene Zubehör**  
Accessory not included  
**LED-IPERION-REMOTE**  
8031414879083  
FANEU00006497  
Multifunktionsfernbedienung / Remote control multi-mode control  
\* nur mit Multifunktionsfernbedienung LED-IPERION-REMOTE einstellbar / \* adjustable only with LED-IPERION-REMOTE remote control



**Enthaltenes Zubehör / Included accessories**  
Pfahl 60 cm / Pole 60 cm  
Solarpanel / Solar panel



**50W - lithium 12,8V 54000 mAh**  
**75W - lithium 25,6V 36000 mAh**  
Aufladbare Batterie, nicht ersetzbar / Rechargeable battery not replaceable



Pfahleintritt 60 mm / 60 mm pole entry

**Photometrie des Produkts / Photometric curve**

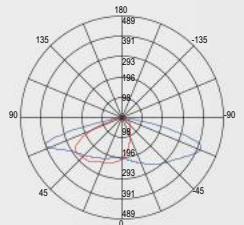

LED-IPERION-50-SOLAR

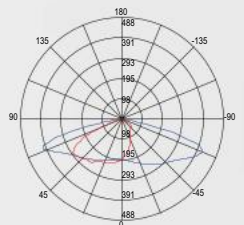

LED-IPERION-75-SOLAR



Dämmerungssensor ON 80 % Licht  
Nach 20 Sekunden 20 % Licht /  
Crepuscular sensor ON 80% light  
After 20 seconds 20% light

Bewegungssensor ON 80 % Licht  
Nach 20 Sekunden 20 % Licht /  
Motion sensor ON 80% light  
After 20 seconds 20% light

# ROADWAY

**Graue LED-Straßenleuchte aus Metall mit langer Lebensdauer und 5 Jahren Garantie. In mehreren Größen erhältlich, bietet ein doppeltes Montagesystem und dank der Beständigkeit gegen Stöße, Staub und Wasserstrahlen hervorragende Leistungen.**

LED street light in metal with grey finish, with extended life cycle and 5-year warranty. Available in various sizes, it features a dual mounting system and excellent performance in terms of protection against impacts, dust and water jets.





1-10V DC



**Material**  
Aluminium

**Farbe**  
Silber



**Farbtemperatur**  
3000K / 4000K



**Driver**  
inklusive

**Lebensdauer**  
50.000 h

**Material**  
aluminium

**Colour**  
silver



**Colour temperature**  
3000K / 4000K



**Driver**  
included

**Life time**  
50.000 h



**LED-ROADWAY-50C**

8031414936076  
FANEU00026472  
lumen

colour temp. colour



8250 lm

**LED-ROADWAY-50M**

8031414936083  
FANEU00026476  
lumen

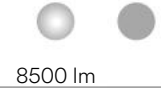

8500 lm

watt 50W  
beam angle 75° x 150°  
pf 0.90

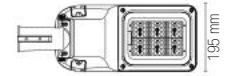

**LED-ROADWAY-100C**

8031414936090  
FANEU00026477  
lumen

colour temp. colour



16500 lm

**LED-ROADWAY-100M**

8031414936106  
FANEU00026478  
lumen

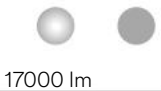

17000 lm

watt 100W  
beam angle 75° x 150°  
pf 0.90



**LED-ROADWAY-150C**

8031414936113  
FANEU00026479  
lumen

colour temp. colour



24750 lm

**LED-ROADWAY-150M**

8031414936120  
FANEU00026480  
lumen



25500 lm

watt 150W  
beam angle 75° x 150°  
pf 0.90

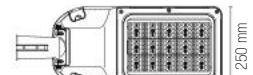

**LED-ROADWAY-200C**

8031414936137  
FANEU00026481  
lumen

colour temp. colour



33000 lm

**LED-ROADWAY-200M**

8031414936144  
FANEU00026482  
lumen



34000 lm

watt 200W  
beam angle 75° x 150°  
pf 0.90

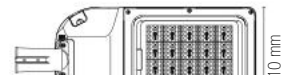

Photometrie des Produkts / Photometric curve

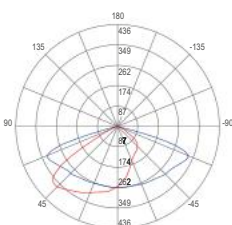

LED-ROADWAY-50W

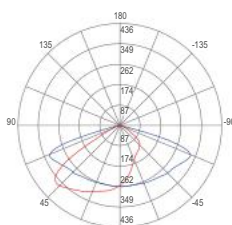

LED-ROADWAY-100W

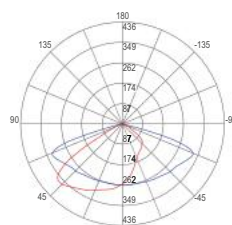

LED-ROADWAY-150W

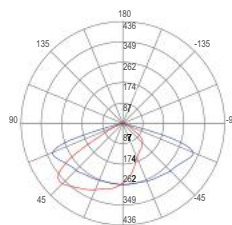

LED-ROADWAY-200W

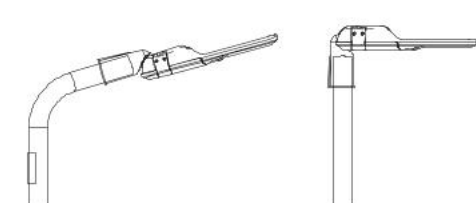

Doppeltes Montagesystem. Für Pfahl Ø 60 mm /  
Double mounting system. Fit for Ø 60 mm pole

# STREETWAY

**Straßenleuchte mit integrierter LED in verschiedenen Formaten mit Struktur aus Aluminiumdruckguss und Diffusor mit Linsen aus selbstlöschendem, stoßfestem und UV-beständigem Material. Garantiert eine lange Lebensdauer und Schutz vor Stößen, Staub und Wasserstrahlen.**

Street light with integrated LED, available in various sizes, with die-cast aluminium fixture and diffuser with lenses in self-extinguishing, impact-resistant and UV-resistant material. It ensures an extended life cycle and protection against impacts, dust and water jets.





**Material**  
Aluminium

**Farbe**  
Silber



**Farbtemperatur**  
4000K



**Driver**  
inklusive

**Lebensdauer und on/off**  
50.000 h  
>25.000 on/off

**Material**  
aluminium

**Colour**  
silver



**Colour temperature**  
4000K



**Driver**  
included

**Life time and on/off**  
50.000 h  
>25.000 on/off



**LED-STREETWAY-50**

8031414876334  
FANEU00007489  
lumen

colour temp.	colour
7800 lm	

watt	50W
beam angle	80° x 140°
pf	0.90

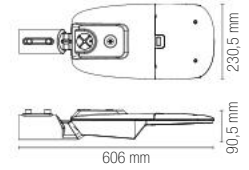

**LED-STREETWAY-100**

8031414876341  
FANEU00007485  
lumen

colour temp.	colour
15500 lm	

colour temp.	colour
15500 lm	
crepuscular sensor	on 6 lux off 50 lux

watt	100W
beam angle	80° x 140°
pf	0.90

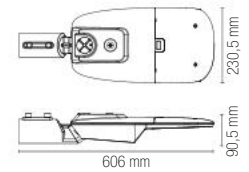

**LED-STREETWAY-150**

8031414876358  
FANEU00007487  
lumen

colour temp.	colour
22000 lm	

watt	150W
beam angle	80° x 140°
pf	0.90

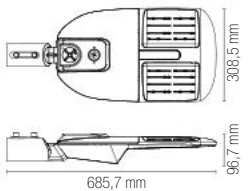

**LED-STREETWAY-200**

8031414879106  
FANEU00007488  
lumen

colour temp.	colour
29900 lm	

watt	200W
beam angle	80° x 140°
pf	0.90

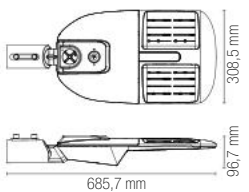

**Photometrie des Produkts / Photometric curve**

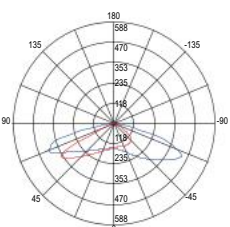

LED-STREETWAY-50W

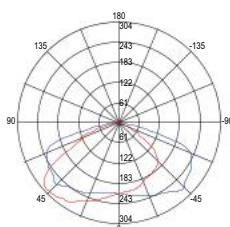

LED-STREETWAY-100W

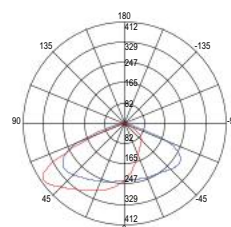

LED-STREETWAY-150W

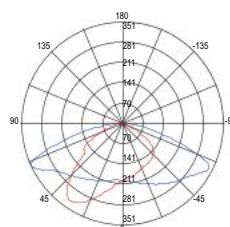

LED-STREETWAY-200W

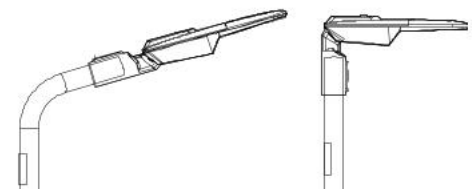

Doppeltes Montagesystem. Für Pfahl Ø 60 mm /  
Double mounting system. Fit for Ø 60 mm pole

# HIGHWAY

**Straßenleuchte mit integrierter LED und Diffusor mit Linsen aus selbstlöschendem, stoßfestem und UV-beständigem Material sowie Metallstruktur mit anthrazitfarbenem Finish. In verschiedenen Größen und mit unterschiedlicher Lichtleistung angeboten.**

Street light with integrated LED, diffuser with lenses in self-extinguishing, impact-resistant and UV-resistant material, and metal fixture with anthracite finish. Available in various sizes and luminous outputs.





- Material**  
Aluminium

---

- Farbe**  
Anthrazit
- 

---

- Farbtemperatur**  
4000K
- 

---

- Driver**  
inklusive

---

- Lebensdauer und on/off**  
30.000 h  
>15.000 on/off

---

- Material**  
aluminum

---

- Colour**  
anthracite
- 

---

- Colour temperature**  
4000K
- 

---

- Driver**  
included



---

- Life time and on/off**  
30.000 h  
>15.000 on/off



**LED-HIGHWAY-50**

8031414877034  
FANEU00006405  
lumen

colour temp.	colour
	
7500 lm	

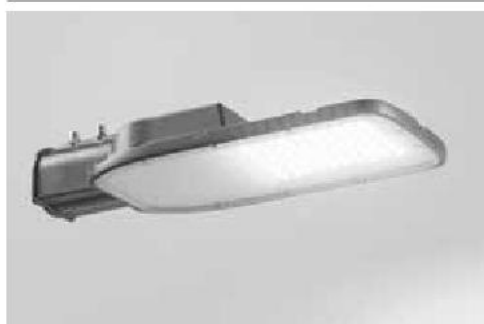
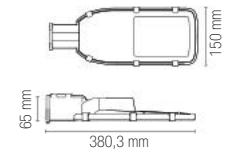

watt	50W
beam angle	135° x 80°
pf	0.90

Pfahleintritt 60 mm /  
60 mm pole entry



**LED-HIGHWAY-100**

8031414877041  
FANEU00006397  
lumen

colour temp.	colour
	
14000 lm	

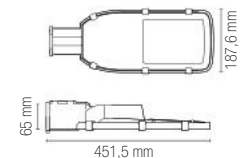

watt	100W
beam angle	135° x 80°
pf	0.90

Pfahleintritt 60 mm /  
60 mm pole entry



**LED-HIGHWAY-150**

8031414877058  
FANEU00006401  
lumen

colour temp.	colour
	
20000 lm	

watt	150W
beam angle	135° x 80°
pf	0.90

Pfahleintritt 60 mm /  
60 mm pole entry

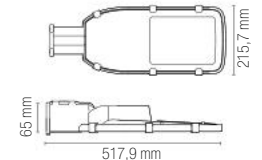

**LED-HIGHWAY-ADAT**

8031414877904  
FANEU00006408

90°-Adapter  
Highway-Straßenleuchtenanbringung  
Pfahleintritt 60 mm /  
90° adapter 60 mm pole entry for street light

Pfahleintritt 60 mm /  
60 mm pole entry

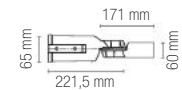

Photometrie des Produkts / Photometric curve

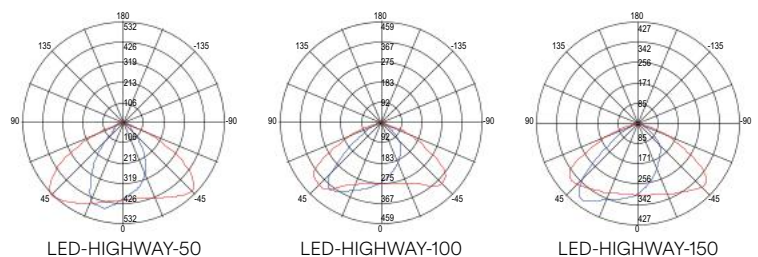

LED-HIGHWAY-50

LED-HIGHWAY-100

LED-HIGHWAY-150

# EXPO



**LED-Flutlichtstrahler aus Aluminiumdruckguss mit anthrazitfarbener Farbe. Durch das moderne Design garantiert er eine lange Lebensdauer, Schutz vor Stößen und eignet sich auch für die Reinigung mit Hochdrucksystemen.**

LED street light in die-cast aluminium with anthracite finish. With its modern design, it ensures long-lasting durability, impact protection, and is suitable for cleaning even with high-pressure systems.

- Material**  
Aluminiumdruckguss

---

- Farbe**  
Anthrazit

---

- Farbtemperatur**  
3000K / 4000K

---

- Driver**  
inklusive

---

- Lebensdauer und on/off**  
50.000 h  
>25.000 on/off

---

- Material**  
die-cust aluminum

---

- Colour**  
anthracite

---

- Colour temperature**  
3000K / 4000K

---

- Driver**  
included

---

- Life time and on/off**  
50.000 h  
>25.000 on/off



**LED-EXPO-60C**  
8031414936038  
FANEU00026463  
lumen

colour temp.	colour
8700 lm	

**LED-EXPO-60M**  
8031414936045  
FANEU00026468  
lumen

colour temp.	colour
9000 lm	

watt	60W
beam angle	60°
pf	0.90

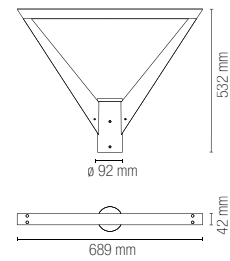

Pfahleintritt 76 mm  
76 mm pole entry



**LED-EXPO-VILLA-ADAT**  
8031414947843  
FANEU00028380

Stangenadapter 60-76 cm kompatibel mit LED-EXPO-60 und LED-VILLA-100 / Pole adapter 60-76 cm compatible with LED-EXPO-60 and LED-VILLA-100

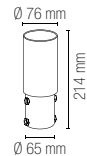

Pfahleintritt 60 mm / 60 mm pole entry

Photometrie des Produkts / Photometric curve

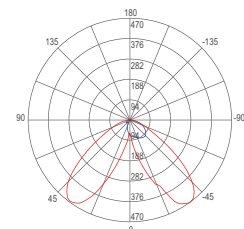

LED-EXPO-60

# VILLA





1-10V DC



**Integrierter LED-Scheinwerfer aus Aluminiumdruckguss mit Anthrazit-Finish. Zertifiziert für die Beständigkeit gegen starke Wasserstrahlen und den optimalen Schutz gegen Stöße, bietet er außerdem eine hervorragende Farbwiedergabe.**

Street light with integrated LED in die-cast aluminium with anthracite finish. Certified for resistance to powerful water jets and optimum impact-resistance, it also provides excellent colour rendering.

**Material**  
Aluminiumdruckguss

**Farbe**  
Anthrazit

**Farbtemperatur**  
3000K / 4000K



**Driver**  
inklusive

**Lebensdauer und on/off**  
50.000 h  
>25.000 on/off

**Material**  
die-cust aluminum

**Colour**  
anthracite



**Colour temperature**  
3000K / 4000K



**Driver**  
included

**Life time and on/off**  
50.000 h  
>25.000 on/off



**LED-VILLA-100C**

8031414936052  
FANEU00026469

lumen 14500 lm

**LED-VILLA-100M**

8031414936069  
FANEU00026470

lumen 15000 lm

watt 100W

beam angle 90°

pf 0.90

colour temp. colour



Pfahleintritt 76 mm  
76 mm pole entry

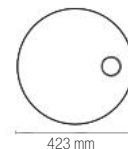

**LED-EXPO-VILLA-ADAT**

8031414947843  
FANEU00028380

Stangenadapter 60-76 cm kompatibel mit LED-EXPO-60 und LED-VILLA-100 / Pole adapter 60-76 cm compatible with LED-EXPO-60 and LED-VILLA-100



Pfahleintritt 60 mm /  
60 mm pole entry

**Photometrie des Produkts / Photometric curve**

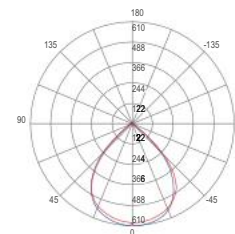

LED-VILLA-100





**Easy Domotic 24V**  
decorative

# EASY DOMOTICA 24V









Mit diesem technischen Segment möchten wir dem wachsenden Bedarf daran gerecht werden, die Qualität von Privat- und Arbeitsleben durch den Einsatz von Beleuchtungsgeräten zu verbessern, die durch Wireless-Technologien zunehmend vereinfachte Anbindungen immer stärker miteinander verknüpft sind.

Die Beleuchtungsgeräte werden zu extrem individuell gestalteten und modularen Elementen, die sich, auch zu unterschiedlichen Tageszeiten, an die veränderten Anforderungen an Beleuchtung anpassen, die nicht mehr nur als solche an sich dient, sondern auf verschiedene Stimmungen, sowohl der gewerblichen als auch der häuslichen oder spielerischen Nutzung, abgestimmt ist. Dieser Abschnitt gruppiert die verschiedenen Typologien von mit 24 V betriebenen Produkten (z. B. Indoor und Outdoor), die dank der Verwendung von Easy-Connector-Zubehör zur gleichzeitigen Steuerung miteinander verbunden werden können. Die Steuerung der Geräte wird easy: Der Anschluss an parallel geschaltete Konstantspannungsnetzteile ist mit Funkfrequenz 2.4G, Infrarot, Wi-Fi oder Bluetooth betriebenen Steuergeräten kompatibel und die Steuergeräte ihrerseits sehen Wi-Fi- bzw. Bluetooth-Schnittstellen vor oder können mittels Wall Pads oder Funksteuerungen gesteuert werden.

With this technical segment, we intend meet in the best way the growing need to improve the quality of home and working life through the use of lighting devices that are increasingly interconnected with each other through connections that are increasingly simplified by wireless technologies.

The lighting devices become an extremely personalized and modular tool that merge, even at different times of the day, with the evolved lighting needs no longer as light source itself but light adapted to the different moods of both professional users, domestic users, playful users. This section groups 24V products (for example indoor or outdoor) that, thanks to easy connector accessories, can be connected each other for simultaneous control.

Devices control becomes easy: constant voltage power supply in parallel connection system are compatible with 2.4G Radio Frequency, Infrared, Wifi or Bluetooth control units and the control units can be controlled by wifi, bluetooth devices or via a wall pad or remote control.

	<p><b>CAVO-4CH-CONN-MF</b>             8031414878772            FANEU00000585            100 cm, Anschlusskabel            M+F-Verbinder /            100 cm, connection            cable M+F connector</p>	
	<p><b>CAVO-4CH-CONN-T</b>             8031414878789            FANEU00000586            40 + 20 cm, Anschlusskabel            mit T-Verbinder M+F+F /            40+20 cm, T connection            cable M+F+F connector</p>	
	<p><b>CAVO-4CH-CONN-M</b>             8031414878796            FANEU00000584            50 cm, Anschlusskabel            F-Verbinder + lose Kabel /            50 cm, connection            cable F+cables</p>	



# TARGET

Flutlichtstrahler aus Aluminium inklusive Pflock, eingebautes Easy-Connection-Kabel.

Aluminum flood light with spike included, built-in easy domotic cable.

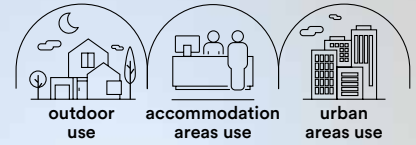

**Material**  
Aluminium

**Farbe**  
Schwarz



**Farbtemperatur**  
RGB + 4000K



**Driver**

DC 24 V  
Konstantspannung  
nicht enthalten

**Lebensdauer und on/off**  
30.000h  
>15.000 on/off

**Material**  
aluminium

**Colour**  
black



**Colour temperature**  
RGB + 4000K



**Driver**

DC 24V  
constant voltage  
not included

**Life time and on/off**  
30.000h  
>15.000 on/off



Driver ab S. /from p. 414  
Controller ab S. /from p. 430

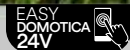
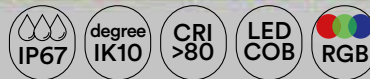

**LED-TARGET-8-24V**  
8031414878604  
FANEU00007515  
lumen

colour temp.



190 lm

watt 8W  
beam angle 30°

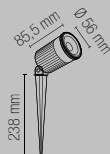

**LED-TARGET-30-24V**  
8031414878550  
FANEU00007512  
lumen

colour temp.



468 lm

watt 30W  
beam angle 30°

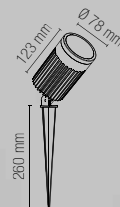

Photometrie des Produkts /  
Photometric curve

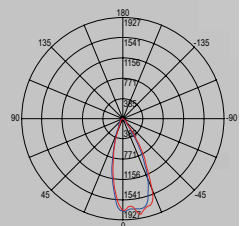

LED-TARGET-8-24V

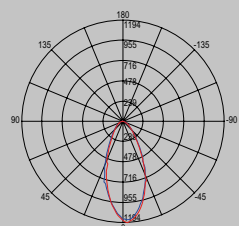

LED-TARGET-30-24V

EASY DOMOTIC 24V

In.tec light

# AGILITY





Driver ab S. /from p. 414  
Controller ab S. /from p. 430



**Material**  
Aluminium,  
Diffusor aus Glas

**Farbe**  
Schwarz



**Farbtemperatur**  
RGB + 4000K



**Driver**  
DC 24V  
Konstantspannung  
nicht enthalten

**Lebensdauer und on/off**  
20.000h  
>10.000 on/off

**Material**  
aluminum  
glass diffuser

**Colour**  
black



**Colour temperature**  
RGB



**Driver**  
DC 24V  
constant voltage  
not included

**Life time and on/off**  
20.000h  
>10.000 on/off

**Flutlichtleuchte mit eingebauter LED  
us schwarzem Aluminium und  
transparentem Diffusor.**

Built-in LED aluminium flood lamp black  
finish with transparent diffuser.



**LED-AGILITY-36-24V**  
8031414915828  
FANEU00005726  
lumen

colour  
temp.  
 +   
735 lm

watt 36W  
beam angle 120°

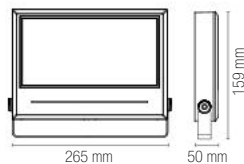

**LED-AGILITY-72-24V**  
8031414915835  
FANEU00005728  
lumen

colour  
temp.  
 +   
1540 lm

watt 72W  
beam angle 120°

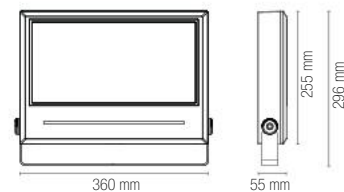

**Photometrie des Produkts / Photometric curve**

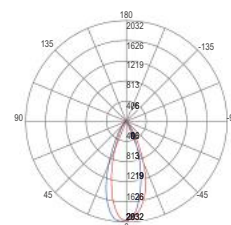

LED-AGILITY-36-24V

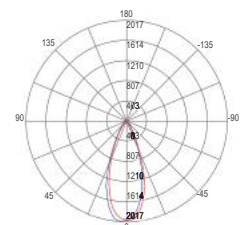

LED-AGILITY-72-24V

# QUICK





Driver ab S. /from p. 414  
Controller ab S. /from p. 430



**Material**  
Aluminium,  
Diffusor aus Glas

**Farbe**  
Schwarz



**Farbtemperatur**  
RGB



**Driver**

DC 24V  
Konstantspannung  
nicht enthalten

**Durata e on/off**

20.000h  
>10.000 on/off

**Material**  
aluminium  
glass diffuser

**Colour**  
black



**Colour temperature**  
RGB



**Driver**

DC 24V  
constant voltage  
not included

**Life time and on/off**

20.000h  
>10.000 on/off

**Integrierter LED-Projektor aus schwarzem Aluminium und transparentem Diffusor.**  
Integrated LED projector in black aluminum and transparent diffuser.



**LED-QUICK-36-24V**

8031414915842  
FANEU00007172  
lumen

colour temp.  
 +   
735 lm

watt 36W  
beam angle 120°

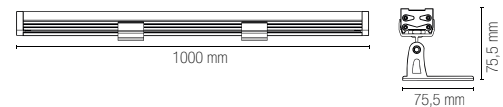

**LED-QUICK-72-24V**

8031414915859  
FANEU00007174  
lumen

+   
1800 lm

watt 72W  
beam angle 120°

**Photometrie des Produkts / Photometric curve**

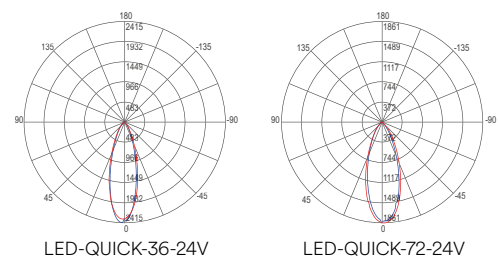

# SPRINT

Einbau-Orientierungsleuchten an Boden oder Wand mit eingebautem Easy-Connection-Kabel.

Inground and wall recessed light with built-in easy domotic cable.



**Material**  
Aluminium

**Farbe**  
Stahl



**Farbtemperatur**  
RGB + 4000K



**Driver**

DC 24V  
Konstantspannung  
nicht enthalten

**Lebensdauer und on/off**

25.000h  
>10.000 on/off

**Material**

aluminium

**Colour**

stainless steel



**Colour temperature**

RGB + 4000K



**Driver**

DC 24V  
constant voltage  
not included

**Life time and on/off**

25.000h  
>10.000 on/off



Driver ab S. /from p. 414  
Controller ab S. /from p. 430



**LED-SPRINT-R5-24V**

8031414878543

FANEU00007441

lumen

colour  
temp.



60 lm

watt

1,5W

beam angle

108°

pressure loads

max 100 kg



Ø 42 mm

Ø 50 mm



**Photometrie des Produkts /  
Photometric curve**

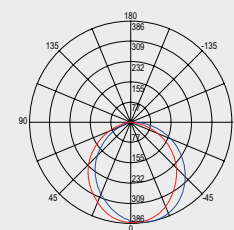

LED-SPRINT-R5-24V



# RUNNER

Einbau-Orientierungsleuchten an Boden oder Wand mit eingebautem Easy-Connection-Kabel.

Inground and wall recessed light with built-in easy domotic cable.



**Material**  
Aluminium

**Farbe**  
Nickel, gebürstet



**Farbtemperatur**  
RGB + 4000K



**Driver**

DC 24V  
Konstantspannung  
nicht enthalten

**Lebensdauer und on/off**

30.000h  
>15.000 on/off

**Material**  
aluminium

**Colour**  
brushed nickel



**Colour temperature**  
RGB + 4000K



**Driver**

DC 24V  
constant voltage  
not included

**Life time and on/off**

30.000h  
>15.000 on/off



Driver ab S. /from p. 414  
Controller ab S. /from p. 430



## LED-RUNNER-Q8-24V

8031414878536  
FANEU00007315  
lumen

colour temp.  
1020 lm

watt 10W  
beam angle 30°  
pressure loads max 100 kg  
Ø 63 mm



## LED-RUNNER-R8-24V

8031414878567  
FANEU00007316  
lumen

colour temp.  
1020 lm

watt 10W  
beam angle 30°  
pressure loads max 100 kg  
Ø 63 mm



Photometrie des Produkts /  
Photometric curve

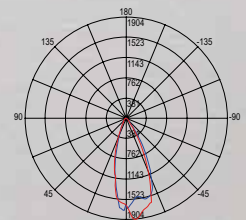

LED-RUNNER-Q8-24V  
LED-RUNNER-R8-24V

Enthaltenes Zubehör /  
Accessories included

x1  
Abzweigdose /  
Recessed box

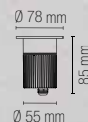
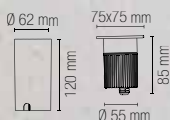

EASY DOMOTIC 24V

In.tec light





**Technische DMX-Dekorleuchten / DMX Technical Decoration Lighting**  
decorative

# SHOW WALLWASHER



outdoor  
use



accommodation  
areas use



office  
use



commercial  
areas use



- Material**  
Aluminium
- Farbtemperatur**  
RGBW + UV
- Driver**  
eingebaut
- Lebensdauer und on/off**  
50.000h  
>25.000 on/off
- Material**  
aluminum
- Colour temperature**  
RGBW + UV
- Driver**  
built-in
- Life time and on/off**  
50.000h  
>25.000 on/off

**Vollfarb-LED-Flutlichtleuchte RGB aus Aluminium und Wandfluter mit aufladbarem Batterie mit 9 LED RGBW+UV und eingebautem Empfänger DMX 512 für eine breite Farbpalette durch Mischen von sechs Hauptfarben: Rot, Grün, Blau, Weiß, Amber und Ultraviolett.**

Full color RGB LED projector made of aluminum and rechargeable battery-powered wallwasher with 9 RGBW+UV LEDs and built-in DMX 512 receiver to emit a wide range of colors by mixing six main colors: red, green, blue, white, amber and ultraviolet.



	colour temp.	colour
<b>LED-SHOW-WW9</b> 8031414915446 FANEU00007412 lumen		
	RGBW+UV	
watt	9 x 18W	
beam angle	45°	

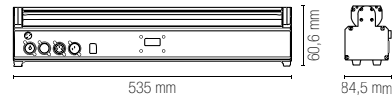

Ladezeit / Charging time	<b>Volle Aufladung in 5 Stunden / Full recharge in 5 hours</b>
Einschaltdauer / Ignition duration	<b>RGBW+UV bei maximaler Helligkeit 3 Stunden / RGBW+UV with maximum brightness 3 hours</b>
Auto-Modus / Auto mode	<b>7 Stunden, monochrom mehr als 20 Stunden / 7 hours monochrome more than 20 hours</b>
Kanal-Modus / Channel mode	<b>6/11 DMX-Kanäle - 16,7 Millionen Farbkombinationen / 6/11 DMX channels - 16.7 million color combinations</b>
Automatikmodi mittels Taste / Automatic modes via push-button	<b>Farbwechsel, Stroboskopfarbe, Farbverdunkelung, gradueller Farbwechsel, stufenweiser Farbwechsel / Color change, strobe color, color dimming, gradual color change, step color change</b>
Control mode	<b>DMX512, master/slave, auto, sound active / Wireless DMX, WiFi mobile phone APP control</b>

**Enthaltenes Zubehör / Accessories included**

- Wi-Fi-Zubehör /  
Wi-Fi accessories
- 5 hours**  
**13200 mAh**  
Aufladbare Batterie, nicht ersetzbar /  
Rechargeable battery, not replaceable

**Control system**

**Smart Bluetooth**

# SHOW PAR

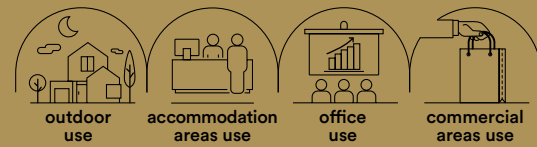

**Material**  
Aluminium

**Farbtemperatur**  
RGBW + UV



**Driver**  
eingebaut

**Lebensdauer und on/off**  
50.000h  
>25.000 on/off

**Material**  
aluminum

**Colour temperature**  
RGBW + UV



**Driver**  
built-in

**Life time and on/off**  
50.000h  
>25.000 on/off

**LED-Flutlichtleuchte mit aufladbarem Batterie mit 9 LEDs RGBW+UV und eingebautem Empfänger DMX 512, eine breite Farbpalette durch Mischen von sechs Hauptfarben: Rot, Grün, Blau, Weiß, Amber und Ultraviolett, sodass jede gewünschte Farbe erzeugt werden kann.**  
Rechargeable battery-powered LED spotlight with 9 RGBW+UV LEDs and built-in DMX 512 receiver, emits a wide range of colors by mixing the six main ones: red, green, blue, white, amber and ultraviolet, allowing you to create any color you want.



	colour temp.	colour
<b>LED-SHOW-PAR9</b> 8031414915439 FANEU00007393 lumen		
	RGBW+UV	
watt	9 x 18W	
beam angle	45°	

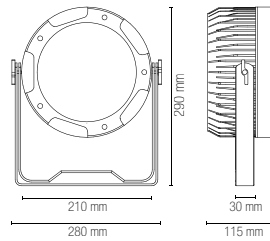

Ladezeit /  
Charging time

Einschaltdauer /  
Ignition duration

Auto-Modus /  
Auto mode

Kanal-Modus /  
Channel mode

Automatikmodi  
mittels Taste /  
Automatic modes  
via push-button

Control mode

**Volle Aufladung in 5 Stunden /  
Full recharge in 5 hours**

**RGBW+UV bei maximaler Helligkeit 3 Stunden /  
RGBW+UV with maximum brightness 3 hours**

**7 Stunden, monochrom mehr als 20 Stunden /  
7 hours monochrome more than 20 hours**

**6/11 DMX-Kanäle - 16,7 Millionen Farbkombinationen /  
6/11 DMX channels - 16.7 million color combinations**

**Farbwechsel, Stroboskopfarbe, Farbverdunkelung,  
gradueller Farbwechsel, stufenweiser Farbwechsel /  
Color change, strobe color, color dimming,  
gradual color change, step color change**

**DMX512, master/slave, auto, sound active/  
Wireless DMX, WiFi mobile phone APP control**

**Enthaltenes Zubehör / Accessories included**



Wi-Fi-Zubehör /  
Wi-Fi accessories



**13200 mAh**  
Aufladbare Batterie, nicht ersetzbar /  
Rechargeable battery, not replaceable

**Control system**



**Smart Bluetooth**

# SHOW Q



outdoor  
use



accommodation  
areas use



office  
use



commercial  
areas use





- Material**  
Aluminium
- Farbtemperatur**  
RGBW + UV
- 
- Driver**  
eingebaut
- Lebensdauer und on/off**  
50.000h  
>25.000 on/off
- Material**  
aluminum
- Colour temperature**  
RGBW + UV
- 
- Driver**  
built-in
- Life time and on/off**  
50.000h  
>25.000 on/off

**LED-Flutlichtleuchte mit aufladbarer Batterie mit 6 LEDs RGBW+UV und eingebautem Empfänger DMX 512, eine breite Farbpalette durch Mischen der sechs Hauptfarben: Rot, Grün, Blau, Weiß, Amber und Ultraviolett, sodass jede gewünschte Farbe erzeugt werden kann.**

Rechargeable battery-operated LED spotlight with 6 RGBW+UV LEDs and built-in DMX 512 receiver, emits a wide range of colors by mixing the six main ones: red, green, blue, white, amber and ultraviolet, allowing the creation of any desired color.



	colour temp.	colour
<b>LED-SHOW-Q6</b> 8031414915408 FANEU00007398		
lumen	RGBW+UV	
watt	6 x 18W	
beam angle	45°	

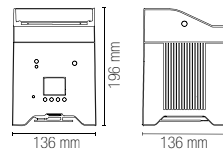

Ladezeit / Charging time	<b>Volle Aufladung in 5 Stunden / Full recharge in 5 hours</b>
Einschaltdauer / Ignition duration	<b>RGBW+UV bei maximaler Helligkeit 3 Stunden / RGBW+UV with maximum brightness 3 hours</b>
Auto-Modus / Auto mode	<b>7 Stunden, monochrom mehr als 20 Stunden / 7 hours monochrome more than 20 hours</b>
Kanal-Modus / Channel mode	<b>6/11 DMX-Kanäle - 16,7 Millionen Farbkombinationen / 6/11 DMX channels - 16.7 million color combinations</b>
Automatikmodi mittels Taste / Automatic modes via push-button	<b>Farbwechsel, Stroboskopfarbe, Farbverdunkelung, gradueller Farbwechsel, stufenweiser Farbwechsel / Color change, strobe color, color dimming, gradual color change, step color change</b>
Control mode	<b>DMX512, master/slave, auto, sound active/ Wireless DMX, WiFi mobile phone APP control</b>

**Nicht enthaltene Zubehör / Accessory not included**



**LED-SHOW-CASE**  
8031414915415  
FANEU00007392  
Koffer mit Ladestation  
für 10 Stück /  
Case with charging  
base for 10 pieces

**Enthaltenes Zubehör / Accessories included**



Wi-Fi-Zubehör /  
Wi-Fi accessories



**9600 mAh**  
Aufladbare Batterie, nicht ersetzbar /  
Rechargeable battery, not replaceable

**Control system**



**Smart Bluetooth**

# SHOW TUBE

**LED-Flutlichtleuchte mit aufladbarem Batterie mit 9 LEDs RGBW+UV und eingebautem Empfänger DMX 512, eine breite Farbpalette durch Mischen der sechs Hauptfarben: Rot, Grün, Blau, Weiß, Amber und Ultraviolett, sodass jede gewünschte Farbe erzeugt werden kann, von warmen bis zu kalten Tönen.**

Rechargeable battery-powered LED spotlight with 9 RGBW+UV LEDs and built-in DMX 512 receiver, emits a wide range of colors by mixing the six main ones: red, green, blue, white, amber and ultraviolet, allowing the creation of any desired color from warm to cool tones.

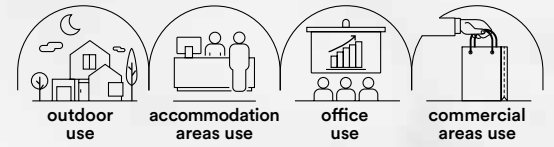

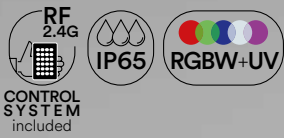

- Material**  
Aluminium

---

- Farbtemperatur**  
RGBW + UV
- 

---

- Driver**  
eingebaut

---

- Lebensdauer und on/off**  
50.000h  
>25.000 on/off

---

- Material**  
aluminum

---

- Colour temperature**  
RGBW + UV
- 

---

- Driver**  
built-in

---

- Life time and on/off**  
50.000h  
>25.000 on/off



**LED-SHOW-TUBE**  
8031414915422  
FANEU00007405  
lumen

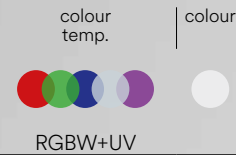

watt 8 x 28W  
beam angle 360°

Ladezeit / Charging time	<b>Volle Aufladung in 5 Stunden / Full recharge in 5 hours</b>
Einschaltzeit / Ignition duration	<b>RGBW+UV bei maximaler Helligkeit 3 Stunden / RGBW+UV with maximum brightness 3 hours</b>
Auto-Modus / Auto mode	<b>7 Stunden, monochrom mehr als 20 Stunden / 7 hours monochrome more than 20 hours</b>
Kanal-Modus / Channel mode	<b>6/11 DMX-Kanäle - 16,7 Millionen Farbkombinationen / 6/11 DMX channels - 16.7 million color combinations</b>
Automatikmodi mittels Taste / Automatic modes via push-button	<b>Farbwechsel, Stroboskopfarbe, Farbverdunkelung, gradueller Farbwechsel, stufenweiser Farbwechsel / Color change, strobe color, color dimming, gradual color change, step color change</b>
Control mode	<b>DMX512, master/slave, auto, sound active/ Wireless DMX, WiFi mobile phone APP control</b>



**Enthaltenes Zubehör / Accessories included**



Wi-Fi-Zubehör /  
Wi-Fi accessories



**10000 mAh**  
Aufladbare Batterie, nicht ersetzbar /  
Rechargeable battery, not replaceable

**Control system**



**Smart Bluetooth**

# RAYS

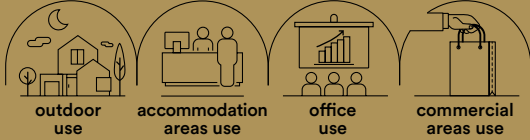



**VOLLFARB-LED-FLUTLICHTLEUCHTE RGB aus Aluminium.**  
LED RGB FULL COLOR lamp in aluminium.

- Material**  
Aluminium

---

- Farbtemperatur**  
RGB full color



---

- Driver**  
inklusive

---

- Lebensdauer und on/off**  
50.000h  
>25.000 on/off

---

- Material**  
aluminium

---

- Colour temperature**  
RGB full color



---



- Driver**  
included

---

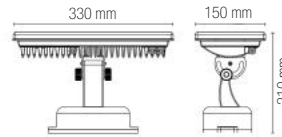
- Life time and on/off**  
50.000h  
>25.000 on/off





**LED-RAYS-36P**  
8031440355445  
FANEU00007264  
lumen

colour temp.	colour
	
RGB	

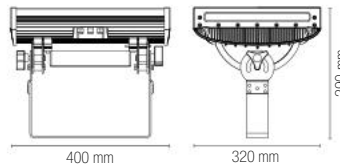
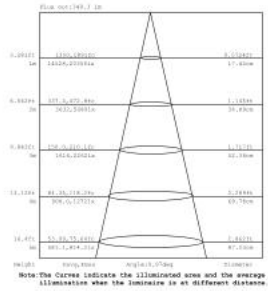
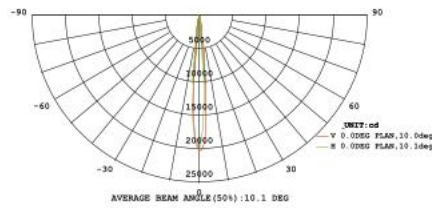
watt 30 × 1W  
beam angle 36°



**LED-RAYS-72P**  
8031440358040  
FANEU00007265  
lumen

colour temp.	colour
	
RGB	

watt 72 × 2W  
beam angle 45°

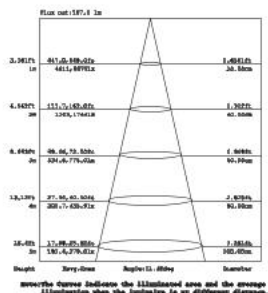
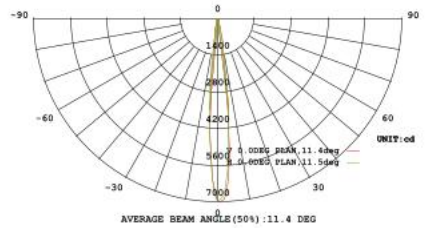

# WALLWASHER

VOLLFARB-LED-FLUTLICHTLEUCHTE RGB aus Aluminium.  
LED RGB FULL COLOR lamp in aluminium.

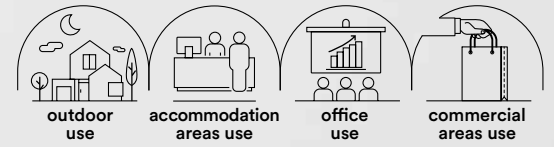

---

**Material**

Aluminium

---

**Farbtemperatur**

RGB full color



---

**Driver**

eingebaut

---

**Lebensdauer und on/off**

50.000h  
>25.000 on/off

---

**Material**

aluminium

---

**Colour temperature**

RGB full color



---

**Driver**

built-in

---

**Life time and on/off**

50.000h  
>25.000 on/off

---





**LED-WALLWASHER-18**

8031440359559  
FANEU00007905  
lumen

colour temp. colour



watt 18 x 2W  
beam angle 45°

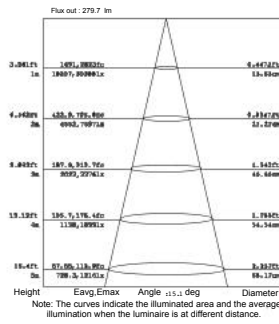
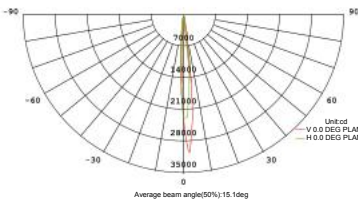
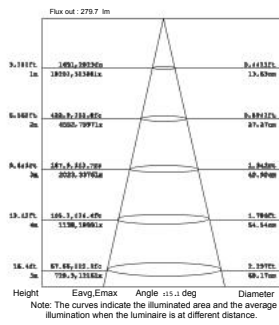
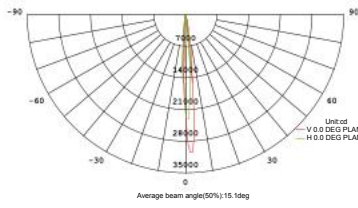

**LED-WALLWASHER-36**

8031440359528  
FANEU00007906  
lumen

colour temp. colour



watt 36 x 2W  
beam angle 45°



# IRIDE

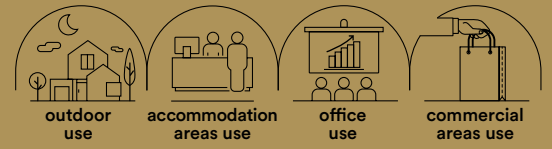



**Einfarbige oder VOLLFARB-LED-FLUT-LICHTLEUCHTE RGB aus Aluminium.**  
LED single colour or RGB FULL COLOR lamp in aluminium.

**Material**  
Aluminium

**Farbtemperatur**  
RGB full color + 6000K



**Driver**  
DC 12/24 V  
nicht enthalten

**Lebensdauer und on/off**  
50.000h  
>25.000 on/off

**Material**  
aluminum

**Colour temperature**  
RGB full color + 6000K



**Driver**  
DC 12/24V  
not included

**Life time and on/off**  
50.000h  
>25.000 on/off



**LED-IRIDE-3P**  
8031440358101  
FANEU00006500  
lumen

colour temp.	colour
RGB	

**LED-IRIDE-3P-BCO**  
8031440359719  
FANEU00006501  
lumen

colour temp.	colour
240 lm	

watt 3 x 1W  
driver DC12/24V  
beam angle 45°

watt 3 x 1W  
driver DC12/24V  
beam angle 30°

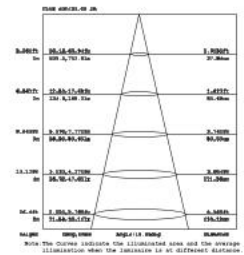
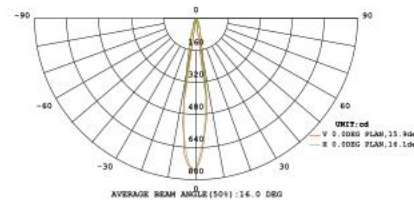
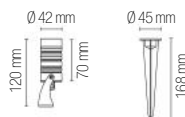

**LED-IRIDE-9P**  
8031440358118  
FANEU00006502  
lumen

colour temp.	colour
RGB	

**LED-IRIDE-9P-BCO**  
8031440359702  
FANEU00006503  
lumen

colour temp.	colour
720 lm	

watt 9 x 1W  
driver DC12/24V  
beam angle 40°

watt 9 x 1W  
driver DC12/24V  
beam angle 30°

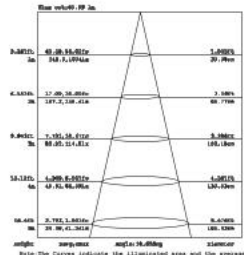
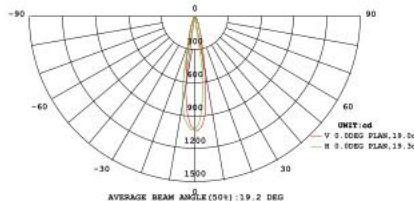
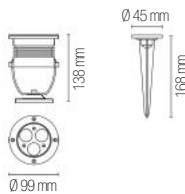

**LED-IRIDE-18P**  
8031440358088  
FANEU00006498  
lumen

colour temp.	colour
RGB	

**LED-IRIDE-18P-BCO**  
8031440359689  
FANEU00006499  
lumen

colour temp.	colour
1620 lm	

watt 18 x 1W  
driver DC24V  
beam angle 40°

watt 18 x 1W  
driver DC24V  
beam angle 30°

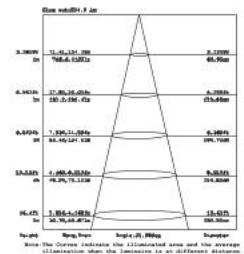
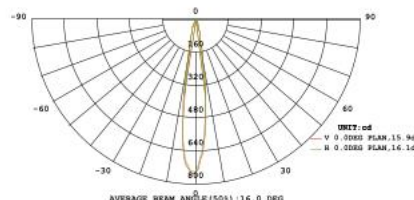
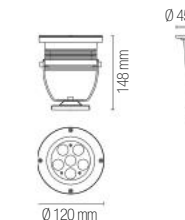

# IRIDE

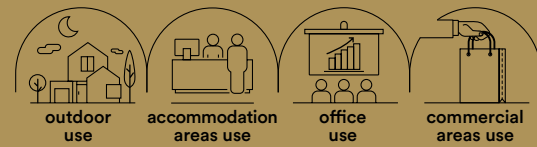



**Begehbare Vollfarb-LED-Einbauleuchten RGB, Gehäuse aus Aluminiumlegierung, Ring aus Stahl 316.**  
**Walkable built-in LED RGB FULL COLOR light 316 stainless steel cover and aluminium alloy housing.**

**Material**  
Aluminiumdruckguss

**Farbtemperatur**  
RGB full color



**Driver**  
DC 12/24 V  
nicht enthalten

**Lebensdauer und on/off**  
50.000h  
>25.000 on/off

**Material**  
die cast aluminum

**Colour temperature**  
RGB full color



**Driver**  
DC 12/24V  
not included

**Life time and on/off**  
50.000h  
>25.000 on/off

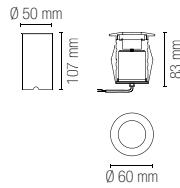

**LED-IRIDE-R6**  
8031414868971  
FANEU00006508  
lumen

colour temp.	colour	recessed box
RGB	RGB	

watt **3 × 1W**  
driver **DC12/24V**  
beam angle **15°**

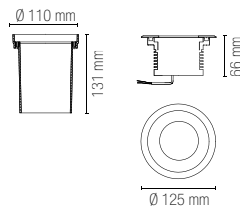
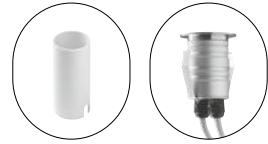
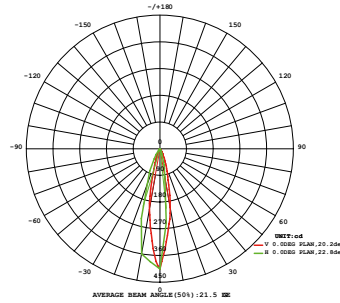

**LED-IRIDE-R12**  
8031414868988  
FANEU00006506  
lumen

colour temp.	colour	recessed box
RGB	RGB	

watt **9 × 1W**  
driver **DC12/24V**  
beam angle **15°**

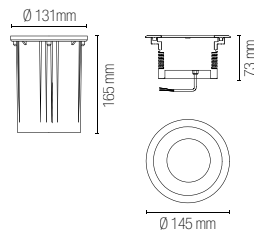
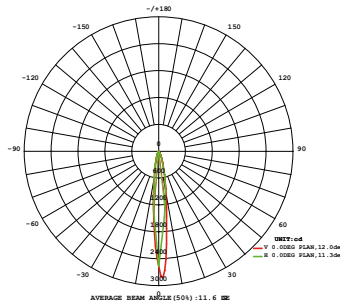

**LED-IRIDE-R14**  
8031414868995  
FANEU00006507  
lumen

colour temp.	colour	recessed box
RGB	RGB	

watt **18 × 1W**  
driver **DC12/24V**  
beam angle **15°**

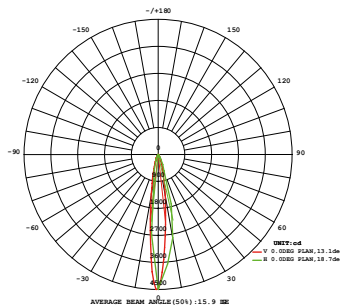

# NEPTUNE

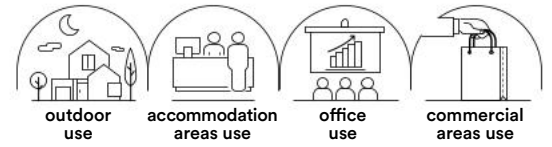

**Material**  
Edelstahl 316

**Farbe**  
Silber  
Schwarz



**Farbtemperatur**  
RGB full color



**Driver**  
DC 24 V  
nicht enthalten

**Lebensdauer und on/off**  
50.000h  
>25.000 on/off

**Material**  
316 stainless steel

**Colour**  
black  
silver



**Colour temperature**  
RGB full color



**Driver**  
DC24V  
not included

**Life time and on/off**  
50.000h  
>25.000 on/off

**VOLLFARB-LED-FLUTLICHTLEUCHE**  
**RGB für Springbrunnen.**  
LED RGB FULL COLOR fountain flood lamp.



**LED-NEPTUNE-3P**  
8031414869008  
FANEU00006840  
lumen

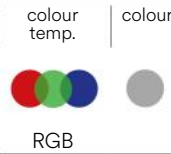

watt 3 × 3W  
beam angle 25°

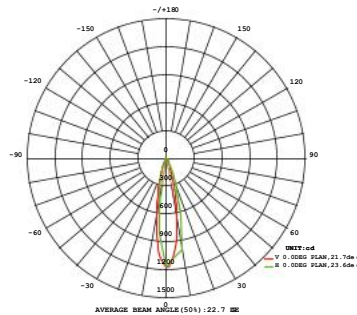
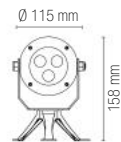

Height	Beam Max	Beam Min	Beam Area	Beam Angle
0.381m	79.48.108.220	790.9.118818	1.2872m	30.350m
0.952m	18.87.27.8820	197.7.291.222	2.8342m	78.64m
0.952m	0.144.13.8820	97.88.139.412	2.7722m	114.96m
19.182m	4.388.4.7840	69.49.72.9812	8.6892m	183.21m
14.4m	2.888.4.3880	31.46.41.9812	6.2882m	121.49m

**LED-NEPTUNE-36P**  
8031440358057  
FANEU00006839  
lumen

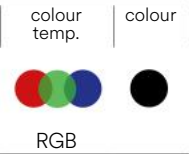

watt 36 × 1W  
beam angle 45°

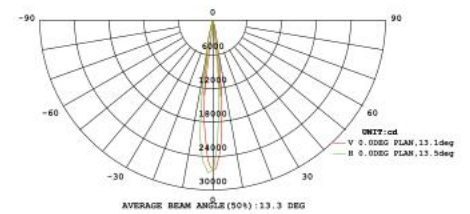
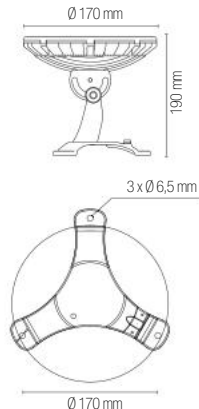

Height	Beam Max	Beam Min	Beam Area	Beam Angle
0.381m	148.728820	1839.297812	0.74220	29.290m
0.952m	37.1877.380	4541.400612	1.3282	44.570m
0.952m	187.4.278.380	3052.297812	2.2822	69.250m
19.182m	109.4.133.480	1177.137412	8.6892	99.140m
14.4m	87.33.99.1320	777.75.10712	8.8122	118.490m

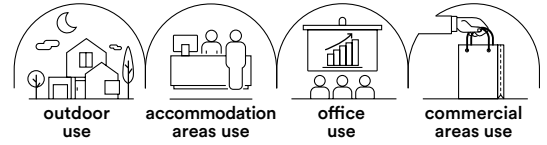

**Material**  
Edelstahl 316

**Farbtemperatur**  
RGB full color



**Driver**  
DC 24 V  
nicht enthalten

**Lebensdauer und on/off**  
50.000h  
>25.000 on/off

**Material**  
316 stainless steel

**Colour temperature**  
RGB full color



**Driver**  
DC24V  
not included

**Life time and on/off**  
50.000h  
>25.000 on/off

**VOLLFARB-LED-EINBAULEUCHE**  
**RGB für Springbrunnen.**  
LED RGB FULL COLOR fountain recess lamp.



	colour temp.	colour
<b>LED-CROWN-R14</b> 8031414869015 FANEU00006019 lumen	RGB	RGB
watt	9 x 2W	
beam angle	25°	

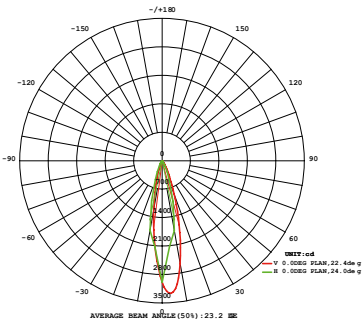
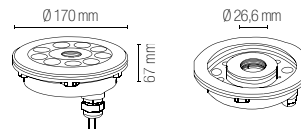

Flux out: 250.4 lm

Height	Beam diam	Angle at 12.000m	Flux out
2.000m	180.3.200.10m	1.201FL	2.000m
4.000m	360.6.400.20m	2.402FL	4.000m
6.000m	540.9.600.30m	3.603FL	6.000m
8.000m	720.1.200.40m	4.804FL	8.000m
10.000m	900.3.000.50m	6.005FL	10.000m
12.000m	1080.5.000.60m	7.206FL	12.000m
14.000m	1260.7.000.70m	8.407FL	14.000m
16.000m	1440.9.000.80m	9.608FL	16.000m



# TREVIS







VOLLFARB-LED-LEUCHTE RGB für Unterwassereinbau.  
Immersion recessed light LED RGB FULL COLOR.

- Material**  
Edelstahl 316
- Farbtemperatur**  
RGB full color
- 
- Driver**  
DC 24 V  
nicht enthalten
- Lebensdauer und on/off**  
50.000h  
>25.000 on/off
- Material**  
316 stainless steel
- Colour temperature**  
RGB full color
- 
- Driver**  
DC 24V  
not included
- Life time and on/off**  
50.000h  
>25.000 on/off





**LED-TREVIS-R7**  
8031414869022  
FANEU00007612  
lumen

colour temp.	colour	recessed box
		
RGB		

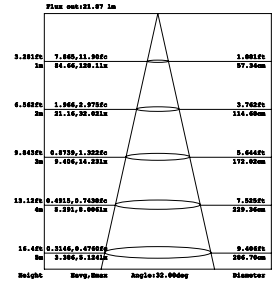
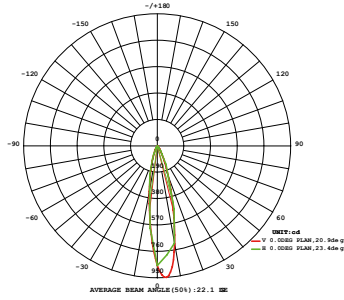
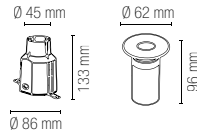
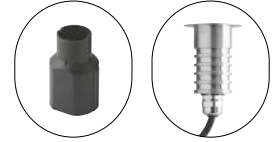
watt	3W
beam angle	25°



**LED-TREVIS-R11**  
8031414869039  
FANEU00007611  
lumen

colour temp.	colour	recessed box
		
RGB		

watt	9W
beam angle	25°

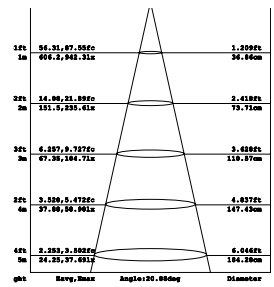
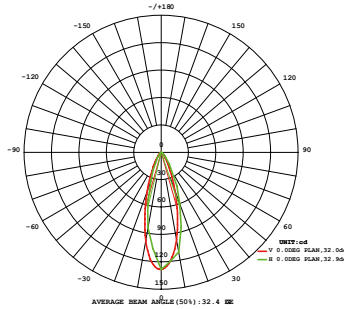
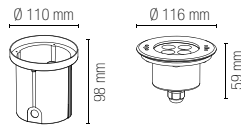

# PAR56

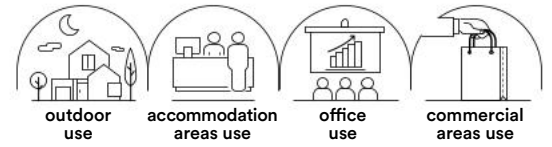

**Material**  
Polycarbonat

**Farbtemperatur**  
RGB full color + 6500K



**Driver**  
AC 12 V nicht enthalten  
DC 24 V nicht enthalten

**Lebensdauer und on/off**  
50.000h  
>25.000 on/off

**Material**  
PC

**Colour temperature**  
RGB full color + 6500K



**Driver**  
AC 12V not included  
DC 24V not included

**Life time and on/off**  
50.000h  
>25.000 on/off

**LED-Unterwasserleuchte für Swimmingpools.**  
Pool immersion LED down light.

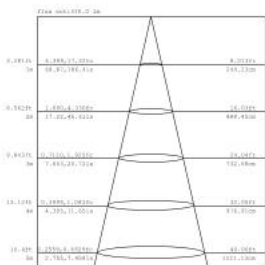
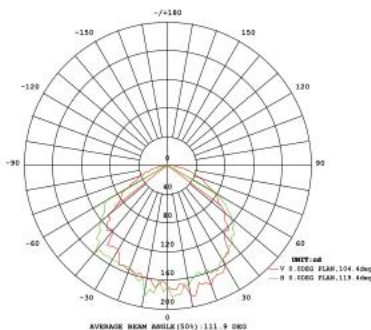

Note: The Curves indicate the illuminated area and the average illumination when the luminaire is at different distance.

	colour temp.	colour
<b>LED-PAR56-24V-RGB</b> 8031414879755 FANEU00007022 lumen	RGB	
watt		21W
driver		DC24V
beam angle		45°
1 m cable included		
<b>LED-PAR56-BCO</b> 8031440359504 FANEU00007023 lumen	1050 lm	
watt		21W
driver		12V AC
beam angle		45°

**INC-POOL-PAR56**  
8031440359511  
FANEU00005024

Einbaustruktur für PAR 56 für Beton-Pools /  
Recessed structure for PAR56 for concrete swimming pool

1 m cable included



Ø 260 mm

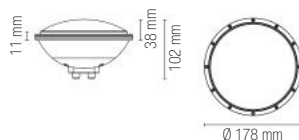
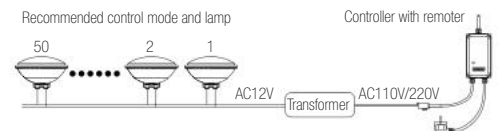

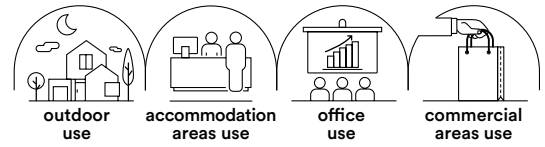

**Material**

Polycarbonat

**Farbtemperatur**

RGB full color + 6500K



**Driver**

AC 12 V nicht enthalten  
DC 24 V nicht enthalten

**Lebensdauer und on/off**

50.000h  
>25.000 on/off

**Material**

PC

**Colour temperature**

RGB full color + 6500K



**Driver**

AC 12V not included  
DC 24V not included

**Life time and on/off**

50.000h  
>25.000 on/off

**LED-Leuchte für Swimmingpool mit Wandbefestigung.**

Pool LED wall lamp.



	colour temp.	colour
<b>LED-PELPS24V-RGB</b>		
8031414868872		
FANEU00007095		
lumen	RGB	
watt		18W
driver		DC24V
beam angle		45°
1 m cable included		
<b>LED-PELPS-BCO</b>		
8031414865420		
FANEU00007093		
lumen	1122 lm	
watt		18W
driver		AC12V
beam angle		45°

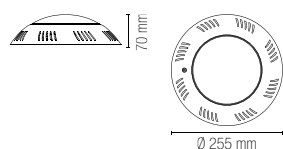

TECHNISCHE DMX-DEKORLEUCHTEN / DMX TECHNICAL DECORATION LIGHTING

In.tec light

# CONTROLLER



## CONTROLLER-POOL

8031440359481  
FANEU00000620

Controller 240 V  
AC MAX 5 A/1100 W  
IP65 Abstand max. 30 M

Controller 240V  
AC max 5A/1100W  
IP65 max distance 30M

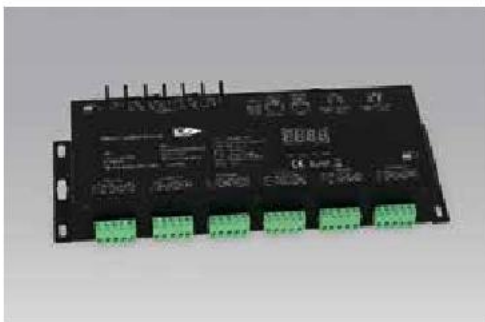
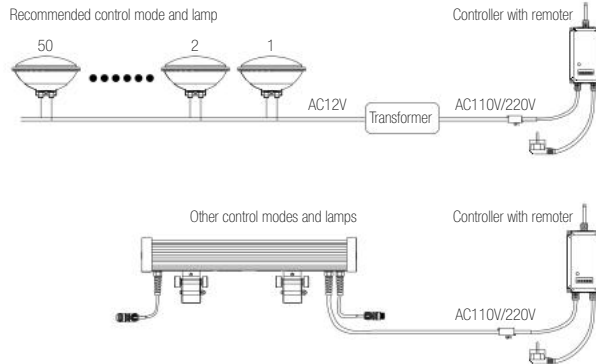
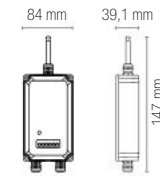
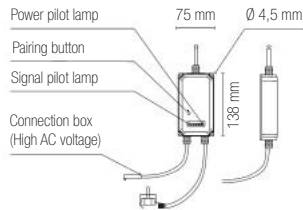

## CONTROLLER-DMX-24

8031414872718  
FANEU00000619

Controller DMX 24 Kanäle  
Konstantspannung 4 A  
Eingang SPANNUNG 12/24 V DC  
Ausgang LEISTUNG 24X(48-96) W  
Ausgang STROM 24X4 A

Controller DMX 24 channels  
Constant voltage 4A  
Input VOLTAGE 12/24V DC  
Output POWER 24X(48-96)W  
Output CURRENT 24X4A

264,5 × 83 × 42 mm



## SPLITTER-DMX-4

8031440359542  
FANEU00008541

SPLITTER DMX  
6W XLR-3X4PCS XLR-5X4PCS

DMX SPLITTER  
6W XLR-3X4PCS XLR-5X4PCS



# CONTROLLER

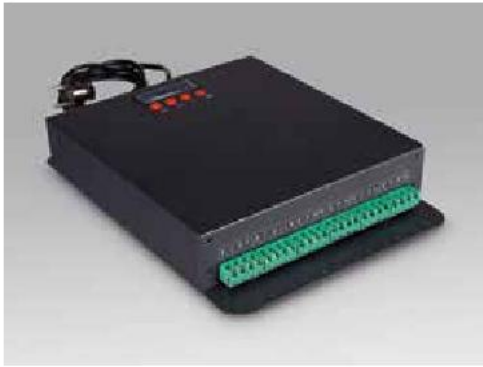

## CONTROLLER-CTR-RGB

8031440358026  
FANEU00000617

Steuergerät  
PORT FÜR DMX512 LED RGB  
Eingang 230 V AC  
Ausgang DC (12 V 144 W - 24 V 300 W)  
6 Ports 3 RGB-Kanäle

Control box with DMX512  
Port for LED RGB  
Input 230V AC  
Output DC (12V 144W - 24V 300W)  
6 ports 3 RGB channels

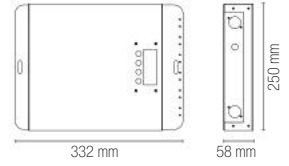

## CONTROLLER-CTR-RGB12

8031440355438  
FANEU00000618

Steuergerät  
PORT FÜR DMX512 LED RGB  
Eingang 230 V AC  
Ausgang DC (12 V 300 W)  
6 Ports 3 RGB-Kanäle

Control box with DMX512  
Port for LED RGB  
Input 230V AC  
Output DC 12V 300W  
6 ports 3 RGB channels

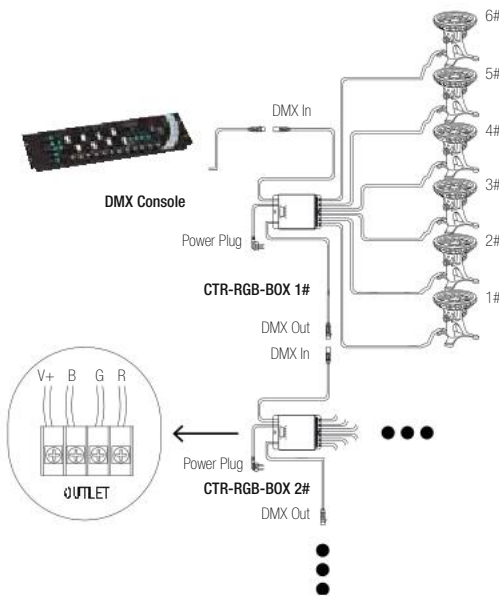

## CONTROLLER-PRO-3

8031440358033  
FANEU00000622

Controller Master 3 Kanäle  
für Flutlichtleuchten  
im Modus EASY  
EIN 230 V AUS DMX/XLR-3  
2 Kanäle IP20

Controller Master 3 channels  
for flood in EASY MODE  
IN 230V OUT DMX/XLR-3  
2 channels IP20

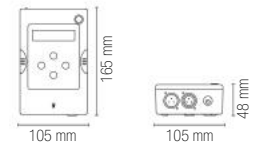

## CONTROLLER-PRO-2

8031440358002  
FANEU00000621

Controller DMX LED  
3 Kanäle RGB AUSGANGSSIGNAL  
DMX/XLR-3 (zwei Ausgänge)  
IP20 mit Ladekabel

Controller DMX LED  
3 channels RGB OUTPUT SIGNAL  
DMX/XLR-3 (two port)  
IP20 with charge cable

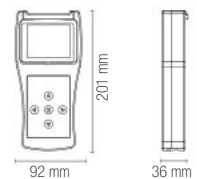
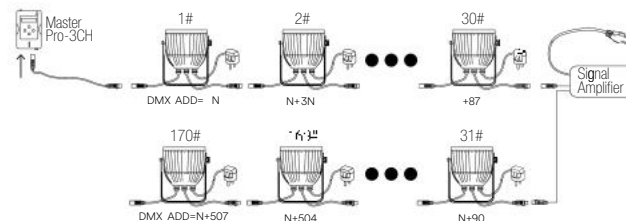

# CONTROLLER



## AMPLIFIER-DMX

8031414936793  
FANEU00026885

Signalverstärker DMX, kompatibel mit dem internationalen Protokoll DMX512, gekennzeichnet durch hervorragende Anpassungsfähigkeit, hohe Zuverlässigkeit und kompakte Abmessungen. Dieses Gerät umfasst Isolatoren mit Optoisolator zwischen den Eingangs- und Ausgangssignalen und garantiert so eine wirksame Trennung zwischen der Gleichstromversorgung und damit eine sicherere Auslegung. Diese Merkmale sorgen für mehr Sicherheit bei der Stromlast und eine stabile und zuverlässige Signalübertragung.

DMX signal amplifier compatible with the international DMX512 protocol, characterized by excellent adaptability, high reliability, and compact dimensions. This device integrates opto-isolator isolators between the input and output signals, ensuring effective separation between the DC power supply for a safer design. These features contribute to a safer load and stable, reliable signal transmission.

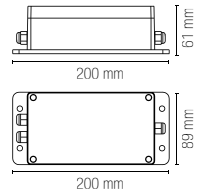

# CONTROLLER

## LED-SUNLITE-U9

8031440359467  
FANEU00007498

SUNLITE Controller  
256 Input-Kanäle  
(max. 218 Steps)

SUNLITE Controller  
256 channels Input  
(218 steps max)

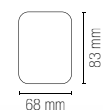

## LED-SUNLITE-GU2

8031422251093  
FANEU00007497

SUNLITE DMX STICK-GU2  
128 Input-Kanäle 240 V

SUNLITE DMX STICK-GU2  
128 channels Input 240V



## LED-SUNLITE-DE3

8031440359498  
FANEU00007496

SUNLITE 2X512 DMX  
ESA PRO/SUITE 2

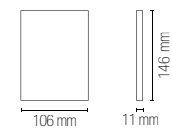





**Beleuchtungskomponenten / Lighting components**  
Zubehör / Accessories

Die Berechnung des richtigen Netzteils für Beleuchtungsprodukte mit Niederspannung ist ein ausschlaggebender Schritt, um die korrekte Funktionsweise und die Sicherheit der Anlage zu garantieren. Im Anschluss ein detaillierter Leitfaden dazu, wie bei dieser Berechnung vorzugehen ist.

**Ermitteln der technischen Daten des Beleuchtungsprodukts. Beginnen Sie damit, die notwendigen Informationen zu den Produkten zusammenzutragen, die Sie verwenden möchten. Zu den wichtigsten technischen Daten gehören:**

- **Nennspannung (V)**  
Die Betriebsspannung des Produkts, z. B. 12V oder 24V.
- **Leistung (W)**  
Die vom Produkt aufgenommene Leistung (Stromverbrauch), die in Watt (W) ausgedrückt wird.  
Dieser Wert ist zur Berechnung des Netzteils unverzichtbar.
- **Berechnen des Gesamtenergieverbrauchs**  
Wenn Sie mehr als eine Beleuchtung versorgen müssen, müssen Sie die Leistung aller Geräte summieren. Wenn Sie zum Beispiel drei 10-W-Glühlampen haben, erfolgt die Berechnung so:  
**Gesamtleistung = 10 W + 10 W + 10 W = 30W**
- **Dabei ist ein Sicherheitsspielraum zu berücksichtigen**  
Es ist empfehlenswert, das Netzteil mit einer höheren Leistung als der für den Betrieb der Geräte erforderlichen zu wählen. Dieser Sicherheitsspielraum trägt dazu bei, Überhitzung vorzubeugen und verlängert die Lebensdauer des Netzteils. Als Faustregel ist ein Spielraum von 20 % bis 30 % vorzusehen. So ergibt sich folgendes Beispiel:  
**Empfohlene Leistung = Leistung insg. x 1,25 = 30W x 1,25 = 37,5 W**  
**Nach Aufrundung kann man ein 40-W-Netzteil wählen.**
- **Prüfen der Ausgangsspannung**  
Vergewissern Sie sich, dass das gewählte Netzteil die gleiche Nennspannung liefert, die von den Beleuchtungsgeräten verlangt wird. Wenn Ihre Produkte mit 12V betrieben werden, muss das Netzteil einen 12-V-Ausgang aufweisen.
- **Kontrolle des Netzteiltyps**  
Es gibt verschiedenen Netzteiltypen, zum Beispiel: Gleichstromnetzteile (DC), die für den Großteil der LED-Glühlampen und anderen Niederspannungsbeleuchtungen erforderlich sind. Schaltnetzteile, die leistungsfähiger, leichter und kompakter sind und sich für verschiedene Anwendungen eignen. Vergewissern Sie sich, dass das gewählte Netzteil mit Ihrer jeweiligen Beleuchtungsart kompatibel ist.
- **Sicherheitszertifizierung kontrollieren**  
Vergewissern Sie sich, dass das Netzteil gemäß den maßgeblichen Sicherheitsstandards zertifiziert ist (CE, UL usw.), um einen sicheren und zuverlässigen Betrieb zu gewährleisten.

#### PRAKTISCHES BEISPIEL

Stellen wir uns vor, wir haben 5 LED-Einbauleuchten mit jeweils 8 W, die mit 24V betrieben werden. Und so wird das Netzteil berechnet:

1. Gesamtleistung:  
5 Einbauleuchten x 8 W = 40 W
2. Sicherheitsspielraum:  
40 W x 1,25 = 50W
3. Wahl des Netzteils  
Ein 24-V-Netzteil mit einer Leistung von mindestens 50W wählen.

Durch Befolgung dieser Schritte sind Sie in der Lage, das für Ihr Niederspannungsbeleuchtungssystem geeignete Netzteil zu wählen und garantieren so optimale und sichere Leistungen.

Calculating the appropriate power supply for low-voltage lighting products is a crucial step in ensuring the proper functioning and safety of the system. Below is a detailed guide on how to proceed with this calculation.

**Identify the Lighting Product Specifications. Start by gathering the necessary information about the lighting products you intend to use. The most important specifications include:**

- **Nominal Voltage (V)**  
The operating voltage of the product, for example, 12V or 24V.
- **Power (W)**  
The power consumed by the product, which can be expressed in watts (W). This value is essential for calculating the power supply.
- **Calculate the total power consumption**  
If you have multiple lighting fixtures to power, you will need to sum the power of all devices. For example, if you have three 10W bulbs, the calculation will be: **Total Power = 10W + 10W + 10W = 30W**
- **Consider a safety margin**  
It is advisable to choose a power supply with a capacity greater than what is required for the operation of the devices. This safety margin helps prevent overheating and increases the lifespan of the power supply itself. A common rule is to add a margin of 20-30%.  
Therefore, in our example:  
**Recommended Power = Total Power x 1.25 = 30W x 1.25 = 37.5W**  
**Rounding up, you might opt for a 40W power supply.**
- **Check the output voltage**  
Make sure that the chosen power supply provides the same nominal voltage required by the lighting devices. If your products operate at 12V, the power supply must have an output of 12V.
- **Check the type of power supply**  
There are different types of power supplies, such as: DC Power Supplies necessary for most LED bulbs and other low-voltage lighting. Switching Power Supplies more efficient, lightweight, and compact, suitable for various applications. Ensure that the chosen power supply is compatible with the type of lighting you have.
- **Check the safety certification**  
Make sure the power supply is certified according to relevant safety standards (CE, UL, etc.) to ensure safe and reliable operation.























#### PRACTICAL EXAMPLE

Let's assume you have 5 LED recessed lights, each consuming 8W, operating at 24V. Here's how to calculate the power supply:













1. Total Power:  
5 fixtures x 8W = 40W
2. Safety Margin:  
40W x 1.25 = 50W
3. Choosing the Power Supply:  
Select a 24V power supply with a capacity of at least 50W.

By following these steps, you will be able to choose the appropriate power supply for your low-voltage lighting system, ensuring optimal and safe performance.

# ZUBEHÖR / ACCESSORIES





































	<b>TRASFORMATORE-120</b> 8031440355094 FANEU00008930 Transformator 120 W Eingang 240 V AC Ausgang 12V AC IP44 10A	 <b>IP44</b>	Voltage power supply 120W Input 240V AC Output 12V AC IP44 10A	180 × 134 × 63 mm
	<b>LED-IRIDE-CAVO-2M-2P</b> 8031440355452 FANEU00006505 2-poliges Kabel für Strahler IRIDE aus weißem Aluminium	 <b>IP65</b>	Cable 2 poles for IRIDE white headlight aluminium	2 metri / 2 meters
	<b>LED-IRIDE-CAVO-2M</b> 8031440358095 FANEU00006504 4-poliges RGB-Kabel für Strahler IRIDE RGB aus weißem Aluminium	 <b>IP65</b>	RGB cable 4 poles for IRIDE RGB white headlight aluminium	2 metri / 2 meters
	<b>CONNETTORE-M</b> 8031440355469 FANEU00000615 Stecker für DMX	 <b>IP68</b>	Male connector for DMX	
	<b>CONNETTORE-F</b> 8031440355476 FANEU00000611 Buchse für DMX	 <b>IP68</b>	Female connector for DMX	
	<b>CONNECTBOX-IP68-3</b> 8031440358903 FANEU00000609 3-polige Anschlussdose	 <b>IP68</b>	Connection box with three poles	35 × 115 × 71 mm
	<b>CONNECTBOX-IP68-2</b> 8031440358927 FANEU00000608 2-polige Anschlussdose	 <b>IP68</b>	Connection box with two poles	30 × 115 × 41 mm
	<b>GUAINA</b> 8031440355483 FANEU00000906 Isolierummantelung	 <b>IP65</b>	Insulating sheath	
	<b>CONNETTORE-IP20</b> 8031414897681 FANEU00000612 Verbinder IP20 2L+2N		IP20 2L+2N Connector	
	<b>CONNETTORE-IP65</b> 8031414897698 FANEU00000613 Verbinder IP65	 <b>IP65</b>	IP65 Connector	
	<b>CONNETTORE-IP68</b> 8031414897704 FANEU00000614 Verbinder IP68	 <b>IP68</b>	IP68 Connector	
	<b>CONNETTORE-T-IP68</b> 8031414949076 FANEU00028513 Verbinder IP68	 <b>IP68</b>	IP68 Connector	

# DRIVER

































Driver MINI and LT		<b>I-DRIVER/4W</b> 8031414862801 FANEU00001704 MINI-Driver Konstantstrom Ausgang 2-12V 350 mA 4W Eingang 100 ~ 240 V	<b>Konstantstrom / constant current</b>	 IP65	38 × 27 × 21 mm
		<b>I-DRIVER/4W-24V</b> 8031414871797 FANEU00001705 MINI-Driver Konstantstrom Ausgang 24V DC 0,17 A 4W Eingang 100 ~ 240 V AC 50 ~ 60 H	<b>Konstantspannung / constant voltage</b>	 IP65	38 × 27 × 21 mm
<b>Driver LT 24V Ultradünne Konstantspannungsnetzteile / Ultra Thin Constant Voltage Power Supplies</b>		<b>I-DRIVER-LT-30-24</b> 8031414896196 FANEU00001668 LT-Driver Konstantspannung Ausgang 24VDC 1,25 A 30W Eingang 220 ~ 240V AC	<b>Konstantspannung / constant voltage</b>	251 × 30 × 16 mm	
		<b>I-DRIVER-LT-45-24</b> 8031414941087 FANEU000027788 LT-Driver Konstantspannung Ausgang 24VDC 1,87 A 45W Eingang 220 ~ 240V AC	<b>Konstantspannung / constant voltage</b>	251 × 30 × 16 mm	
		<b>I-DRIVER-LT-60-24</b> 8031414896202 FANEU00001669 LT-Driver Konstantspannung Ausgang 24VDC 2,5 A 60W Eingang 220 ~ 240V AC	<b>Konstantspannung / constant voltage</b>	305 × 30 × 18,2 mm	
		<b>I-DRIVER-LT-75-24</b> 8031414876822 FANEU00001671 LT-Driver Konstantspannung Ausgang 24VDC 3,12 A 75W Eingang 220 ~ 240V AC	<b>Konstantspannung / constant voltage</b>	305 × 30 × 17 mm	
		<b>I-DRIVER-LT-100-24</b> 8031414896226 FANEU00001664 LT-Driver Konstantspannung Ausgang 24VDC 4,17 A 100W Eingang 220 ~ 240V AC	<b>Konstantspannung / constant voltage</b>	312 × 30 × 18,2 mm	
		<b>I-DRIVER-LT-150-24</b> 8031414876846 FANEU00001665 LT-Driver Konstantspannung Ausgang 24V DC 6,25 A 150W Eingang 220 ~ 240V AC	<b>Konstantspannung / constant voltage</b>	336 × 30 × 17 mm	
		<b>I-DRIVER-LT-200-24</b> 8031414896240 FANEU00001667 LT-Driver Konstantspannung Ausgang 24VDC 8,34 A 200W Eingang 220 ~ 240V AC	<b>Konstantspannung / constant voltage</b>	335 × 30 × 21,6 mm	
		<b>I-DRIVER-LT-240-24</b> 8031414941100 FANEU000027790 LT-Driver Konstantspannung Ausgang 24VDC 0-10 A 240W Eingang 220 ~ 240V AC	<b>Konstantspannung / constant voltage</b>	357 × 32 × 22,5 mm	

# DRIVER

Ultradünne Konstantspannungsnetzteile,  
dimmbar, Phasenschnitt und Dali /  
Ultra Thin Constant Voltage Power Supplies  
Dimmable Phase Cutting and Dali

Driver LT 24V DIMM Phasenschnitt / Driver LT 24V DIMM phase-cut	 	<b>I-DRIVER-LT-100-24T</b> 8031414941414 FANEU00027802 Dimmerfunktion mit Phasenschnitt sowohl Leading Edge als auch Trailing Edge 1-100 % LT-Driver Konstantspannung Ausgang 24VDC 1,38 ~ 4,17 A von 33W bis 100W Eingang 220 ~ 240V AC	<b>Konstantspannung / constant voltage</b>  Phase-cut dimming function, both Leading Edge and Trailing Edge 1-100% LT constant voltage driver Output 24VDC 1,38 ~ 4,17A 33 to 100W Input 220 ~ 240V AC	  TRIAC-ELV 400 × 21,6 × 32 mm
	 	<b>I-DRIVER-LT-150-24T</b> 8031414941421 FANEU00027803 Dimmerfunktion mit Phasenschnitt sowohl Leading Edge als auch Trailing Edge 1-100 % LT-Driver Konstantspannung Ausgang 24VDC 2,06 ~ 6,25 A von 50W bis 150W Eingang 220~240V AC	<b>Konstantspannung / constant voltage</b>  Phase-cut dimming function, both Leading Edge and Trailing Edge 1-100% LT constant voltage driver Output 24VDC 2.06 ~ 6.25A 50 to 150W Input 220 ~ 240V AC	  TRIAC-ELV 400 × 21,6 × 32 mm
	 	<b>I-DRIVER-LT-200-24T</b> 8031414941438 FANEU00027804 Dimmerfunktion mit Phasenschnitt sowohl Leading Edge als auch Trailing Edge 1-100 % LT-Driver Konstantspannung Ausgang 24VDC 0,2 ~ 8,33 A 200W Eingang 220 ~ 240V AC	<b>Konstantspannung / constant voltage</b>  Phase-cut dimming function, both Leading Edge and Trailing Edge 1-100% LT constant voltage driver Output 24VDC 0,2 ~ 8,33A 200W Input 220 ~ 240V AC	  TRIAC-ELV 450 × 32 × 23 mm
	 	<b>I-DRIVER-LT-240-24T</b> 8031414941445 FANEU00027805 Dimmerfunktion mit Phasenschnitt sowohl Leading Edge als auch Trailing Edge 1-100 % LT-Driver Konstantspannung Ausgang 24VDC 3,33 ~ 10 A 240W Eingang 220 ~ 240V AC	<b>Konstantspannung / constant voltage</b>  Phase-cut dimming function, both Leading Edge and Trailing Edge 1-100% LT constant voltage driver Output 24VDC 3,33 ~ 10A 240W Input 220 ~ 240V AC	  TRIAC-ELV 450 × 23 × 32 mm
Driver LT 24V DALI2 push	 	<b>I-DRIVER-LT-75-24D</b> 8031414941124 FANEU00027792 Dimmerfunktion 0,1-100 % Dimmerschalter - DALI 2 LT-Driver Konstantspannung Ausgang 24VDC 0 - 3,125 A 75W Eingang 220 ~ 240V AC	<b>Konstantspannung / constant voltage</b>  Dimming function 0.1-100% switch dimm - DALI 2 LT constant voltage driver Output 24VDC 0 - 3,125A 75W Input 220 ~ 240V AC	  PUSH-DIM 400 × 21,6 × 32 mm
	 	<b>I-DRIVER-LT-100-24D</b> 8031414941131 FANEU00027793 Dimmerfunktion 0,1-100 % Dimmerschalter - DALI 2 LT-Driver Konstantspannung Ausgang 24VDC 0 - 4,17 A 100W Eingang 220 ~ 240V AC	<b>Konstantspannung / constant voltage</b>  Dimming function 0.1-100% switch dimm - DALI 2 LT constant voltage driver Output 24VDC 0 - 4,17A 100W Input 220 ~ 240V AC	  PUSH-DIM 400 × 21,6 × 32 mm
	 	<b>I-DRIVER-LT-150-24D</b> 8031414941148 FANEU00027794 Dimmerfunktion 0,1-100 % Dimmerschalter - DALI 2 LT-Driver Konstantspannung Ausgang 24VDC 0 - 6,25 A 150W Eingang 220 ~ 240V AC	<b>Konstantspannung / constant voltage</b>  Dimming function 0.1-100% switch dimm - DALI 2 LT constant voltage driver Output 24VDC 0 - 6.25A 150W Input 220 ~ 240V AC	  PUSH-DIM 400 × 21,6 × 32 mm
	 	<b>I-DRIVER-LT-200-24D</b> 8031414941155 FANEU00027795 Dimmerfunktion 0,1-100 % Dimmerschalter - DALI 2 LT-Driver Konstantspannung Ausgang 24VDC 0 - 8,33 A 200W Eingang 220 ~ 240V AC	<b>Konstantspannung / constant voltage</b>  Dimming function 0.1-100% switch dimm - DALI 2 LT constant voltage driver Output 24VDC 0 - 8.33A 200W Input 220 ~ 240V AC	  PUSH-DIM 450 × 23 × 32 mm
	 	<b>I-DRIVER-LT-240-24D</b> 8031414941162 FANEU00027796 Dimmerfunktion 0,1-100 % Dimmerschalter - DALI 2 LT-Driver Konstantspannung Ausgang 24VDC 0 - 10 A 240W Eingang 220 ~ 240V AC	<b>Konstantspannung / constant voltage</b>  Dimming function 0.1-100% switch dimm - DALI 2 LT constant voltage driver Output 24VDC 0 - 10A 240W Input 220 ~ 240V AC	  PUSH-DIM 450 × 23 × 32 mm

# DRIVER

<p><b>Dimmbare ultradünne Konstantspannungsnetzteile von Dali. Driver LT 24V</b></p> <p><b>2 Ausgangskanäle und Dimmerfunktion DALI2</b></p> <p>DALI-2 DT8-Integration für die native Steuerung von Tunable White LED-Streifen über eine einzige Adresse</p>	 	<p><b>I-DRIVER-LT-75-24DTW</b> 8031414941179 FANEU00027797</p> <p>LT Driver Konstantspannung Dimmerfunktionen DALI2 DT8 und PUSH-Dimming, mit Dimming-Speicher 0,1% ~ 100% Ausgang 24VDC 3,12 A 75W Eingang 220 ~ 240V AC</p>	<p><b>Konstantspannung / constant voltage</b></p> <p>LT constant voltage driver with DALI2 DT8 dimming functions and PUSH dimming, with dimming memory from 0.1~100% Output 24VDC 3,12A 75W Input 220 ~ 240V AC</p>	   <p>400 × 32 × 21,6 mm</p>
<p><b>Dali Dimmable Ultrathin Constant Voltage Power Supplies. Driver LT 24V 2 output channels and DALI2 dimming</b></p> <p>DALI-2 DT8 integration for native control of Tunable White LED strips via a single address</p>	 	<p><b>I-DRIVER-LT-100-24DTW</b> 8031414941186 FANEU00027798</p> <p>LT Driver Konstantspannung Dimmerfunktionen DALI2 DT8 und PUSH-Dimming, mit Dimming-Speicher 0,1% ~ 100% Ausgang 24VDC 0 - 4,17 A 100W Eingang 220 ~ 240V AC</p>	<p><b>Konstantspannung / constant voltage</b></p> <p>LT constant voltage driver with DALI2 DT8 dimming functions and PUSH dimming, with dimming memory from 0.1% to 100% Output 24VDC 0 - 4.17A 100W Input 220 ~ 240V AC</p>	   <p>400 × 32 × 21,6 mm</p>
	 	<p><b>I-DRIVER-LT-150-24DTW</b> 8031414941384 FANEU00027799</p> <p>LT Driver Konstantspannung Dimmerfunktionen DALI2 DT8 und PUSH-Dimming, mit Dimming-Speicher 0,1% ~ 100% Ausgang 24VDC 0 - 6,25 A 150W Eingang 220 ~ 240V AC</p>	<p><b>Konstantspannung / constant voltage</b></p> <p>LT constant voltage driver with DALI2 DT8 dimming functions and PUSH dimming, with dimming memory from 0.1% to 100% Output 24VDC 0 - 6.25A 150W Input 220 ~ 240V AC</p>	   <p>400 × 32 × 21,6 mm</p>
	 	<p><b>I-DRIVER-LT-200-24DTW</b> 8031414941391 FANEU00027800</p> <p>Driver Konstantspannung Dimmerfunktionen DALI2 DT8 und PUSH-Dimming, mit Dimming-Speicher 0,1% ~ 100% Ausgang 24VDC 2,78~8,33 A 200W Eingang 220 ~ 240V AC</p>	<p><b>Konstantspannung / constant voltage</b></p> <p>LT constant voltage driver with DALI2 DT8 dimming functions and PUSH dimming, with dimming memory from 0.1% to 100% Output 24VDC 2,78~8,33 A 200W Input 220 ~ 240V AC</p>	   <p>50 × 32 × 23 mm</p>
	 	<p><b>I-DRIVER-LT-240-24DTW</b> 8031414941407 FANEU00027801</p> <p>LT Driver Konstantspannung Dimmerfunktionen DALI2 DT8 und PUSH-Dimming, mit Dimming-Speicher 0,1% ~ 100% Ausgang 24VDC 0 - 10 A 240W Eingang 220 ~ 240V AC</p>	<p><b>Konstantspannung / constant voltage</b></p> <p>LT constant voltage driver with DALI2 DT8 dimming functions and PUSH dimming, with dimming memory from 0.1% to 100% Output 24VDC 0 - 10A 240W Input 220 ~ 240V AC</p>	   <p>450 × 32 × 23 mm</p>
<p><b>Driver LT 48V</b></p>	 	<p><b>I-DRIVER-LT-60-48</b> 8031414896219 FANEU00001670</p> <p>LT-Driver Konstantspannung Ausgang 48VDC 1,25 A 60W Eingang 220 ~ 240V AC</p>	<p><b>Konstantspannung / constant voltage</b></p> <p>LT constant voltage driver Output 48VDC 1.25A 60W Input 220 ~ 240V AC</p>	<p>305 × 30 × 18,2 mm</p>
	 	<p><b>I-DRIVER-LT-100-48</b> 8031414941094 FANEU00027789</p> <p>LT-Driver Konstantspannung Ausgang 48VDC 0 - 2,08 A 100W Eingang 220 ~ 240V AC</p>	<p><b>Konstantspannung / constant voltage</b></p> <p>LT constant voltage driver Output 48VDC 0-2.08A 100W Input 220 ~ 240V AC</p>	<p>312 × 30 × 18,2 mm</p>
	 	<p><b>I-DRIVER-LT-150-48</b> 8031414896233 FANEU00001666</p> <p>LT-Driver Konstantspannung Ausgang 48VDC 3,125 A 150W Eingang 220 ~ 240V AC</p>	<p><b>Konstantspannung / constant voltage</b></p> <p>LT constant voltage driver Output 48VDC 3.125A 150W Input 220 ~ 240V AC</p>	<p>335 × 30 × 21,6 mm</p>
	 	<p><b>I-DRIVER-LT-240-48</b> 8031414941117 FANEU00027791</p> <p>LT-Driver Konstantspannung Ausgang 48VDC 0-5 A 240W Eingang 220 ~ 240V AC</p>	<p><b>Konstantspannung / constant voltage</b></p> <p>LT constant voltage driver Output 48VDC 0-5A 240W Input 220 ~ 240V AC</p>	<p>57 × 32 × 22,5 mm</p>

# NETZTEILE / POWER SUPPLY

Konstantspannungs-  
netzteile LRS  
und RSP 12V /  
Constant voltage  
power supply LRS  
and RSP 12V



## STRIP-DRIVER12V-35W

8031440360265  
FANEU00008698

Ausgang 12V 3 A 36W  
Eingang 85 ~ 264VAC 120 ~ 373VDC

Konstantspannung /  
constant voltage

Output 12V 3A 36W  
Input 85 ~ 264VAC 120 ~ 373VDC

99 × 82 × 30 mm



## STRIP-DRIVER12V-50W

8031414866779  
FANEU00008699

Ausgang 12V 4,2 A 50W  
Eingang 85 ~ 264VAC 120 ~ 373VDC

Konstantspannung /  
constant voltage

Output 12V 4.2A 50W  
Input 85 ~ 264VAC 120 ~ 373VDC

99 × 82 × 30 mm



## STRIP-DRIVER12V-75W

8031439581268  
FANEU00008700

Ausgang 12V 6 A 72W  
Eingang 85 ~ 264VAC 120 ~ 373VDC

Konstantspannung /  
constant voltage

Output 12V 6A 72W  
Input 85 ~ 264VAC 120 ~ 373VDC

99 × 97 × 30 mm



## STRIP-DRIVER12V-100W

8031440359368  
FANEU00008693

Ausgang 12V 8,5 A 102W  
Eingang 85 ~ 264VAC 120 ~ 373VDC

Konstantspannung /  
constant voltage

Output 12V 8.5A 102W  
Input 85 ~ 264VAC 120 ~ 373VDC

129 × 97 × 30 mm



## STRIP-DRIVER12V-150W

8031439611262  
FANEU00008694

Ausgang 12V 12,5 A 150W  
Eingang 85 ~ 132 VAC / 170 ~ 264  
VAC mit Schalter  
240 ~ 370VDC  
(Schalter auf 230VAC)

Konstantspannung /  
constant voltage

Output 12V 12.5A 150W  
Input 85 ~ 132VAC / 170 ~ 264VAC  
by switch  
240 ~ 370VDC (switch on 230VAC)

159 × 97 × 30 mm



## STRIP-DRIVER12V-200W

8031440359375  
FANEU00008695

Ausgang 12V 16,7 A 200W  
Eingang 85 ~ 264VAC 124 ~ 370VDC

Konstantspannung /  
constant voltage

Output 12V 16,7A 200W  
Input 85 ~ 264VAC 124 ~ 370VDC

215 × 115 × 30 mm



## STRIP-DRIVER12V-320W

8031440359344  
FANEU00008697

Ausgang 12V 26,7 A 320W  
Eingang 88 ~ 264VAC 124 ~ 370VDC

Konstantspannung /  
constant voltage

Output 12V 26,7A 320W  
Input 88 ~ 264VAC 124 ~ 370VDC

215 × 115 × 30 mm

# NETZTEILE / POWER SUPPLY

Konstantspannungs-  
netzteile  
LRS und RSP 24V /  
Costant voltage  
power supply  
LRS and RSP 24V



**STRIP-DRIVER24V-35W**  
8031414870943  
FANEU00008705

Ausgang 24V 1,5 A 36W  
Eingang 85 ~ 264VAC 120 ~ 373VDC

**Konstantspannung /  
constant voltage**

Output 24V 1,5A 36W  
Input 85 ~ 264VAC 120 ~ 373VDC

99 × 82 × 30 mm



**STRIP-DRIVER24V-50W**  
8031440364744  
FANEU00008706

Ausgang 24V 2,2 A 52W  
Eingang 85 ~ 264VAC 120 ~ 373VDC

**Konstantspannung /  
constant voltage**

Output 24V 2,2A 52W  
Input 85 ~ 264VAC 120 ~ 373VDC

99 × 82 × 30 mm



**STRIP-DRIVER24V-75W**  
8031414870950  
FANEU00008707

Ausgang 24V 3,2 A 76W  
Eingang 85 ~ 264VAC 120 ~ 373VDC

**Konstantspannung /  
constant voltage**

Output 24V 3,2A 76W  
Input 85 ~ 264VAC 120 ~ 373VDC

99 × 97 × 30 mm



**STRIP-DRIVER24V-100W**  
8031440364751  
FANEU00008701

Ausgang 24V 4,5 A 108 W  
Eingang 85 ~ 264VAC 120 ~ 373VDC

**Konstantspannung /  
constant voltage**

Output 24V 4.5A 108W  
Input 85 ~ 264VAC 120 ~ 373VDC

129 × 97 × 30 mm



**STRIP-DRIVER24V-150W**  
8031414870967  
FANEU00008702

Ausgang 24V 6,5 A 156 W  
Eingang 85 ~ 132VAC / 170 ~  
264VAC mit Schalter  
240 ~ 370VDC  
(Schalter auf 230VAC)

**Konstantspannung /  
constant voltage**

Output 24V 6.5A 156W  
Input 85 ~ 132VAC / 170 ~  
264VAC by switch  
240 ~ 370VDC  
(switch on 230VAC)

159 × 97 × 30 mm



**STRIP-DRIVER24V-200W**  
8031440364737  
FANEU00008703

Ausgang 24V 8,4 A 201 W  
Eingang 85 ~ 264VAC 124 ~ 370VDC

**Konstantspannung /  
constant voltage**

Output 24V 8,4A 201W  
Input 85 ~ 264VAC 124 ~ 370VDC

215 × 115 × 30 mm



**STRIP-DRIVER24V-320W**  
8031414864959  
FANEU00008704

Ausgang 24V 13,4 A 321W  
Eingang 88 ~ 264VAC 124 ~ 370VDC

**Konstantspannung /  
constant voltage**

Output 24V 13,4A 321W  
Input 88 ~ 264VAC 124 ~ 370VDC

215 × 115 × 30 mm

# NETZTEILE / POWER SUPPLY

 	<p><b>I-DRIVER-UHP-200-24</b> 8031414896387 FANEU00001688</p> <p>Ausgang 24V 8,4 A 200W Eingang 90 ~ 264VAC 127 ~ 370VDC</p>	<p><b>Konstantspannung / constant voltage</b></p> <p>Output 24V 8.4A 200W Input 90 ~ 264VAC 127 ~ 370VDC</p>	<p>194 × 55 × 26 mm</p>
<p><b>Konstantspannungs- netzteile UHP 24V / Costant voltage power supply UHP 24V</b></p>  	<p><b>I-DRIVER-UHP-350-24</b> 8031414879618 FANEU00001689</p> <p>Ausgang 24V 14,6 A 350W Eingang 90 ~ 264VAC 127 ~ 370VDC <b>ohne Gebläse</b></p>	<p><b>Konstantspannung / constant voltage</b></p> <p>Output 24V 14.6A 350W Input 90 ~ 264VAC 127 ~ 370VDC <b>without fan</b></p>	<p>220 × 62 × 31 mm</p>
 	<p><b>I-DRIVER-UHP-500-24</b> 8031414879625 FANEU00001690</p> <p>Ausgang 24V 20,9 A 501 W Eingang 90 ~ 264VAC 127 ~ 370VDC <b>ohne Gebläse</b></p>	<p><b>Konstantspannung / constant voltage</b></p> <p>Output 24V 20.9A 501W Input 90 ~ 264VAC 127 ~ 370VDC <b>without fan</b></p>	<p>220 × 62 × 31 mm</p>
<p><b>Konstantspannungs- netzteile RSP 36 V / Costant voltage power supply RSP 36 V</b></p>  	<p><b>STRIP-DRIVER36V-200W</b> 8031414870974 FANEU000008708</p> <p>Ausgang 36 V 5,56 A 200W Eingang 88 ~ 264VAC 124 ~ 370VDC</p>	<p><b>Konstantspannung / constant voltage</b></p> <p>Output 36V 5.56A 200W Input 88 ~ 264VAC 124 ~ 370VDC</p>	<p>215 × 115 × 30 mm</p>
 	<p><b>STRIP-DRIVER36V-320W</b> 8031414864829 FANEU000008709</p> <p>Ausgang 36 V 8,9 A 320W Eingang 88 ~ 264VAC 124 ~ 370VDC</p>	<p><b>Konstantspannung / constant voltage</b></p> <p>Output 36V 8.9A 320W Input 88 ~ 264VAC 124 ~ 370VDC</p>	<p>215 × 115 × 30 mm</p>
<p><b>Konstantspannungs- netzteile RSP 48V / Costant voltage power supply RSP 48V</b></p>  	<p><b>STRIP-DRIVER48V-75W</b> 8031414881536 FANEU000008713</p> <p>Ausgang 48V 1,6 A 76,8 W Eingang 88 ~ 264VAC 124 ~ 370VDC</p>	<p><b>Konstantspannung / constant voltage</b></p> <p>Output 48V 1.6A 76,8W Input 88 ~ 264VAC 124 ~ 370VDC</p>	<p>99 × 97 × 30 mm</p>
 	<p><b>STRIP-DRIVER48V-150W</b> 8031414881529 FANEU000008710</p> <p>Ausgang 48V 3,3 A 158,4W Eingang 85 ~ 132 VAC 240 ~ 370VDC</p>	<p><b>Konstantspannung / constant voltage</b></p> <p>Output 48V 3.3A 158,4W Input 85 ~ 132VAC 240 ~ 370VDC</p>	<p>159 × 97 × 30 mm</p>
 	<p><b>STRIP-DRIVER48V-200W</b> 8031414878307 FANEU000008711</p> <p>Ausgang 48V 4,2 A 201 W Eingang 88 ~ 264VAC 124 ~ 370VDC</p>	<p><b>Konstantspannung / constant voltage</b></p> <p>Output 48V 4.2A 201W Input 88 ~ 264VAC 124 ~ 370VDC</p>	<p>215 × 115 × 30 mm</p>
 	<p><b>STRIP-DRIVER48V-320W</b> 8031414878314 FANEU000008712</p> <p>Ausgang 48V 6,7 A 321,6 W Eingang 88 ~ 264VAC 124 ~ 370VDC</p>	<p><b>Konstantspannung / constant voltage</b></p> <p>Output 48V 6,7 A 321,6 W Input 88 ~ 264VAC 124 ~ 370VDC</p>	<p>215 × 115 × 30 mm</p>

# DRIVER



























		<b>I-DRIVER/18W-24V</b> 8031414875351 FANEU00001699 LPH Output 24V 0.75A 18W Input 180 ~ 264VAC 254 ~ 370VDC	<b>Konstantspannung / constant voltage</b>	 <b>IP67</b>	
		<b>I-DRIVER/18W</b> 8031439571269 FANEU00001698 LPHC Output 6~48V 350mA 16,8W Input 180 ~ 264VAC	<b>Konstantstrom / constant current</b>	 <b>IP67</b>	
<b>Dimmbare Netzteile wählbarer Konstantstrom / Dimmable power supplies selectable constant current</b>			<b>I-DRIVER-DIMM-LCM25</b> 8031414924653 FANEU00001636 LCM dimmable 42W Output DC 0~54V 350mA; 6~50V 500mA; 6~42V 600mA; 6~36V 700mA; 6~28V 900mA; 6~24V 1050mA; Input 180 ~ 277VAC 254~392VDC	<b>Konstantstrom / constant current</b>	 <b>DIM</b> 1-10V DC
		<b>I-DRIVER-DIMM-LCM40</b> 8031439591267 FANEU00001638 LCM dimmable 42W Output DC 2~100V 350mA; 2~80V 500mA; 2~67V 600mA; 2~57V 700mA; 2~45V 900mA; 2~40V 1050mA; Input 180 ~ 295VAC 254~417VDC	<b>Konstantstrom / constant current</b>	 <b>DIM</b> 1-10V DC	
		<b>I-DRIVER-DIMM-LCM60</b> 8031439561260 FANEU00001640 LCM dimmable 60W Output DC 2~90V 500mA; 2~90V 600mA; 2~86V 700mA; 2~67V 900mA; 2~57V 1050mA; 2~42V 1400mA; Input 180 ~ 295VAC 254~417VDC	<b>Konstantstrom / constant current</b>	 <b>DIM</b> 1-10V DC	
		<b>I-DRIVER-DIMM-LCM25DA</b> 8031414924660 FANEU00001637 LCM dimmable 42W Output DC 0~54V 350mA; 6~50V 500mA; 6~42V 600mA; 6~36V 700mA; 6~28V 900mA; 6~24V 1050mA; Input 180 ~ 277VAC 254~380VDC(254~375VDC for DA2-Type)	<b>Konstantstrom / constant current</b>	 <b>DALI</b> PUSH-DIM	
		<b>I-DRIVER-DIMM-LCM40DA</b> 8031414924677 FANEU00001639 LCM dimmable 42W Output DC 2~100V 350mA; 2~80V 500mA; 2~67V 600mA; 2~57V 700mA; 2~45V 900mA; 2~40V 1050mA; Input 180 ~ 295VAC 254 ~ 392VDC	<b>Konstantstrom / constant current</b>	 <b>DALI</b> PUSH-DIM	
		<b>I-DRIVER-DIMM-LCM60DA</b> 8031414924684 FANEU00001641 LCM dimmable 60W Output DC 2~90V 500mA; 2~90V 600mA; 2~86V 700mA; 2~67V 900mA; 2~57V 1050mA; 2~42V 1400mA; Input 180 ~ 295VAC 254 ~ 392VDC	<b>Konstantstrom / constant current</b>	 <b>DALI</b> PUSH-DIM	
		<b>I-DRIVER-HLG-320-12</b> 8031440360258 FANEU00001658 Output 12V 22A 264W Input 90 ~ 305VAC 127 ~ 431VDC	<b>Konstantspannung / constant voltage</b>	 <b>IP67</b>	

# DRIVER

Driver ELG  
24V IP67 dimmbar  
und LPV 24V IP67 /  
Dimmable  
driver ELG 24V IP67  
and LPV 24V IP67

		<b>I-DRIVER-ELG-100-24</b> 8031414876914 FANEU00001642 ELG Dimmable Output 24V 4A 100W Input 100 ~ 305VAC 142 ~ 431VDC continue 320VAC for 24Hrs; 360VAC for 1Hr	<b>Konstantspannung / constant voltage</b>	 	199 × 63 × 35,5 mm
		<b>I-DRIVER-ELG-100-24DA</b> 8031414876921 FANEU00001643 ELG Dimmable DALI Output 24V 4A 100W Input 100 ~ 305VAC 142 ~ 431VDC continue 320VAC for 24Hrs; 360VAC for 1Hr	<b>Konstantspannung / constant voltage</b>	 	199 × 63 × 35,5 mm
		<b>I-DRIVER-ELG-150-24</b> 8031414876891 FANEU00001644 ELG Dimmable Output 24V 6.25A 150W Input 100 ~ 305VAC 142 ~ 431VDC	<b>Konstantspannung / constant voltage</b>	 	219 × 63 × 35,5 mm
		<b>I-DRIVER-ELG-150-24DA</b> 8031414876907 FANEU00001645 ELG Dimmable DALI Output 24V 6.25A 150W Input 100 ~ 305VAC 142 ~ 431VDC	<b>Konstantspannung / constant voltage</b>	 	219 × 63 × 35,5 mm
		<b>I-DRIVER-ELG-240-24</b> 8031414876877 FANEU00001646 ELG Dimmable Output 24V 10A 240W Input 100 ~ 305VAC 142 ~ 431VDC	<b>Konstantspannung / constant voltage</b>	 	244 × 71 × 37,5 mm
		<b>I-DRIVER-ELG-240-24DA</b> 8031414876884 FANEU00001647 ELG Dimmable DALI Output 24V 10A 240W Input 100 ~ 305VAC 142 ~ 431VDC	<b>Konstantspannung / constant voltage</b>	 	244 × 71 × 37,5 mm
		<b>I-DRIVER-LPV-60-24</b> 8031414876839 FANEU00001663 LPV Output 24V 2.5A 60W Input 90 ~ 264VAC 127 ~ 370VDC	<b>Konstantspannung / constant voltage</b>		162,5 × 42,5 × 32 mm
		<b>I-DRIVER-LPV-100-24</b> 8031414876853 FANEU00001661 LPV Output 24V 4.2A 100W Input 90 ~ 264VAC 127 ~ 370VDC	<b>Konstantspannung / constant voltage</b>		190 × 52 × 37 mm
		<b>I-DRIVER-LPV-150-24</b> 8031414876860 FANEU00001662 LPV Output 24V 6.3A 150W Input 180 ~ 305VAC 254 ~ 431VDC	<b>Konstantspannung / constant voltage</b>		191 × 63 × 37,5 mm

# DRIVER

Driver XLG 24V IP67		<b>I-DRIVER-XLG-75-24</b> 8031414873708 FANEU00001694	<b>Konstantspannung / constant voltage</b>	
	Ausgang 24V 3,1 A 75W Eingang 100 ~ 305VAC 142 ~ 431VDC	Output 24V 3.1A 75W Input 100 ~ 305VAC 142 ~ 431VDC	140 × 63 × 32 mm	
		<b>I-DRIVER-XLG-100-24</b> 8031414879595 FANEU00001691	<b>Konstantspannung / constant voltage</b>	
	Ausgang 24V 4 A 100W Eingang 100 ~ 305VAC 142 ~ 431VDC	Output 24V 4A 100W Input 100 ~ 305VAC 142 ~ 431VDC	140 × 63 × 32 mm	
		<b>I-DRIVER-XLG-150-24</b> 8031414879601 FANEU00001692	<b>Konstantspannung / constant voltage</b>	
	Ausgang 24V 6,25 A 150W Eingang 100 ~ 305VAC 142 ~ 431VDC	Output 24V 6.25A 150W Input 100 ~ 305VAC 142 ~ 431VDC	180 × 63 × 35,5 mm	
		<b>I-DRIVER-XLG-200-24</b> 8031414879588 FANEU00001693	<b>Konstantspannung / constant voltage</b>	
	Ausgang 24V 8,3 A 200W Eingang 100 ~ 305VAC 142 ~ 431VDC	Output 24V 8.3A 200W Input 100 ~ 305VAC 142 ~ 431VDC	199 × 63 × 35,5 mm	
		<b>I-DRIVER-XLG-320-V-A</b> 8031414933761 FANEU00025947	<b>Konstantspannung / constant voltage</b>	
	Eingang 12/24V 13~18 A (24V/13 A,12V/18 A) 24V/312 W, 12V/216 W Eingang 100 ~ 305VAC 142 ~ 431VDC	Output 12/24V 13~18A (24V/13A,12V/18A) 24V/312W, 12V/216W Input 100 ~ 305VAC 142 ~ 431VDC	246 × 77 × 39,5 mm	
Driver PWM DALI2		<b>I-DRIVER-PWM-60-24DA</b> 8031414896356 FANEU00001678	<b>Konstantspannung / constant voltage</b>	 
	Ausgang 24V 2,5 A 60W Eingang 90 ~ 305VAC 127 ~ 431VDC DALI2 0.2% - 100% Deep Dimming	Output 24V 2.5A 60W Input 90 ~ 305VAC 127 ~ 431VDC DALI2	150 × 53 × 35 mm	
		<b>I-DRIVER-PWM-120-24DA</b> 8031414896363 FANEU00001676	<b>Konstantspannung / constant voltage</b>	 
	Ausgang 24V 5 A 120 W Eingang 90 ~ 305VAC 127 ~ 431VDC DALI2 0.2% - 100% Deep Dimming	Output 24V 5A 120W Input 90 ~ 305VAC 127 ~ 431VDC DALI2 0.2% - 100% Deep Dimming	191 × 63 × 37,5 mm	
		<b>I-DRIVER-PWM-200-24DA</b> 8031414896370 FANEU00001677	<b>Konstantspannung / constant voltage</b>	 
	Ausgang 24V 8,3 A 200W Eingang 100 ~ 305VAC 142 ~ 431VDC DALI2 0.2% - 100% Deep Dimming	Output 24V 8.3A 200W Input 100 ~ 305VAC 142 ~ 431VDC DALI2 0.2% - 100% Deep Dimming	195 × 68 × 39,5 mm	

# DRIVER

Ultraschmale  
DIN-Schiene  
in Stufenform /  
Ultra Slim Step  
Shape DIN Rail



**I-DRIVER-HDR-60-24**

8031414896271  
FANEU00001651

Ausgang 24V 2,5 A 60W  
Eingang 85~264 VAC  
(277VAC operativ) 120 ~ 370VDC  
(390VAC operativ)

**Konstantspannung /  
constant voltage**

Output 24V 2.5A 60W  
Input 85 ~ 264VAC  
(277VAC operational) 120 ~ 370VDC  
(390VAC operational)

52,5 × 90 × 54,5 mm



**I-DRIVER-HDR-100-24**

8031414896288  
FANEU00001649

Ausgang 24V 3,83 A 100W  
Eingang 85~264 VAC  
(277VAC operativ) 120 ~ 370VDC  
(390VAC operativ)

**Konstantspannung /  
constant voltage**

Output 24V 3.83A 100W  
Input 85 ~ 264VAC  
(277VAC operational) 120 ~ 370VDC  
(390VAC operational)

70 × 90 × 54,5 mm



**I-DRIVER-HDR-150-24**

8031414896295  
FANEU00001650

Ausgang 24V 6,25 A 150W  
Eingang 85~264 VAC  
(277VAC operativ) 120 ~ 370VDC  
(390VAC operativ)

**Konstantspannung /  
constant voltage**

Output 24V 6.25A 150W  
Input 85 ~ 264VAC  
(277VAC operational) 120 ~ 370VDC  
(390VAC operational)

105 × 90 × 54,5 mm

Industrielle  
DIN-Schiene mit  
Einzelausgang /  
Single Output  
Industrial DIN RAIL



**I-DRIVER-NDR-240-24**

8031414896301  
FANEU00001672

Ausgang 24V 10 A 240W  
Eingang 90 ~ 264VAC 127 ~ 370VDC

**Konstantspannung /  
constant voltage**

Output 24V 10A 240W  
Input 90 ~ 264VAC 127 ~ 370VDC

63 × 125,2 × 113,5 mm



**I-DRIVER-NDR-480-24**

8031414896325  
FANEU00001674

Ausgang 24V 20 A 480W  
Eingang 90 ~ 264VAC 127 ~ 370VDC

**Konstantspannung /  
constant voltage**

Output 24V 20A 480W  
Input 90 ~ 264VAC 127 ~ 370VDC

85,5 × 125,2 × 128,5 mm



**I-DRIVER-NDR-240-48**

8031414896318  
FANEU00001673

Ausgang 48V 5 A 240W  
Eingang 90 ~ 264VAC 127 ~ 370VDC

**Konstantspannung /  
constant voltage**

Output 48V 5A 240W  
Input 90 ~ 264VAC 127 ~ 370VDC

63 × 125,2 × 113,5 mm



**I-DRIVER-NDR-480-48**

8031414896332  
FANEU00001675

Ausgang 48V 10 A 480W  
Eingang 90 ~ 264VAC 127 ~ 370VDC

**Konstantspannung /  
constant voltage**

Output 48V 10A 480W  
Input 90 ~ 264VAC 127 ~ 370VDC

85,5 × 125,2 × 128,5 mm

Industrielle  
DIN-Schiene mit  
Einzelausgang  
und PFC-Funktion /  
Single Output  
Industrial DIN RAIL



**I-DRIVER-SDR-960-24**

8031414896349  
FANEU00001679

Ausgang 24V 40 A 960W  
Eingang 180 ~ 264VAC 254 ~ 370VDC

**Konstantspannung /  
constant voltage**

Output 24V 40A 960W  
Input 180 ~ 264VAC 254 ~ 370VDC

110 × 125,2 × 150 mm



**I-DRIVER-DELO42**

8031414897667  
FANEU00001635















Unterstützung für Dimm-Modus  
DALI-2+PushDIM 10-Stufen-Stromaus-  
gang mittels DIP-Schalter weiches  
Dimmen ohne Flackern bei jeder  
Lichtstärke unter Verwendung der  
patentierten HPC-Technologie bleibt  
die Helligkeit der Leuchten bei jeder  
Dimmstufe konstant  
Dimmbereich 1~100%,  
Ausgangsstromgenauigkeit 2%  
Ausgang 6-38/40/42  
VDC 0,45-1,10 A 42W  
Eingang 220 ~ 240VAC  
DALI2 PUSH DIM











**Konstantspannung /  
constant voltage**

Support for DALI-2+pushDIM  
dimming mode  
10-level current output  
achievable via DIP switch  
Soft dimming and  
flicker-free at any brightness  
Using patented HPC technology,  
the brightness of the lights remains  
constant at any dimming level  
Dimming range 1~100%,  
output current accuracy 2%  
Output 6-38/40/42 VDC  
0.45-1.10A 42W  
Input 220 ~ 240VAC  
DALI2 PUSH DIM











103 × 68,5 × 30,5 mm

	<b>I-DRIVER-60-24</b> 8031414897797 FANEU00001633 Ausgang 24V 2,5 A 60W Eingang 176 ~ 264VAC 176 ~ 370VDC	<b>Konstantspannung /            constant voltage</b> Output 24V 2.5A 60W Input 176 ~ 264VAC 176~370VDC	178 × 53 × 23 mm
	<b>I-DRIVER-60-24-IP67</b> 8031414897841 FANEU00001634 Ausgang 24V 2,5 A 60W Eingang 176~264VAC	<b>Konstantspannung /            constant voltage</b> Output 24V 2.5A 60W Input 176 ~ 264VAC	 IP67 160 × 50 × 31 mm
	<b>I-DRIVER-100-24</b> 8031414897803 FANEU00001626 Ausgang 24V 4,1 A 100W Eingang 176 ~ 264VAC 250 ~ 360VDC	<b>Konstantspannung /            constant voltage</b> Output 24V 4.1A 100W Input 176 ~ 264VAC 250 ~ 360VDC	188 × 53 × 23 mm
	<b>I-DRIVER-100-24-IP67</b> 8031414897858 FANEU00001627 Ausgang 24V 4,2 A 100W Eingang 176~264VAC	<b>Konstantspannung /            constant voltage</b> Output 24V 4.2A 100W Input 176 ~ 264VAC	 IP67 220 × 50 × 31 mm
	<b>I-DRIVER-150-24</b> 8031414897810 FANEU00001628 Ausgang 24V 6,3 A 150W Eingang 175 ~ 264VAC 176 ~ 370VDC	<b>Konstantspannung /            constant voltage</b> Output 24V 6.3A 150W Input 175 ~ 264VAC 176 ~ 370VDC	220 × 53 × 23 mm
	<b>I-DRIVER-150-24-IP67</b> 8031414897865 FANEU00001629 Ausgang 24V 6,25 A 150W Eingang 176~264VAC	<b>Konstantspannung /            constant voltage</b> Output 24V 6.25A 150W Input 176 ~ 264VAC	 IP67 230 × 65 × 21 mm
	<b>I-DRIVER-200-24</b> 8031414897827 FANEU00001630 Ausgang 24V 8,3 A 200W Eingang 175 ~ 264VAC 175 ~ 370VDC	<b>Konstantspannung /            constant voltage</b> Output 24V 8.3A 200W Input 175 ~ 264VAC 175 ~ 370VDC	274 × 53 × 23 mm
	<b>I-DRIVER-200-24-IP67</b> 8031414897872 FANEU00001631 Ausgang 24V 8,3 A 200W Eingang 175~264VAC	<b>Konstantspannung /            constant voltage</b> Output 24V 8.3A 200W Input 175 ~ 264VAC	 IP67 230 × 65 × 31 mm
	<b>I-DRIVER-300-24</b> 8031414897834 FANEU00001632 Ausgang 22-24V 11,5 A 300W Eingang 175 ~ 264VAC 175 ~ 370VDC	<b>Konstantspannung /            constant voltage</b> Output 22-24V 11.5A 300W Input 175 ~ 264VAC 175 ~ 370VDC	230 × 65 × 31 mm
	<b>I-DRIVER-300-24-IP67</b> 8031414943357 FANEU000027996 Ausgang 24V 12,5A 300W Eingang 200 ~ 240VAC 2.1A / 230PAC	<b>Konstantspannung /            constant voltage</b> Output 24V 12.5A 300W Input 200 ~ 240VAC 2.1A / 230PAC	 IP67

	<b>I-DRIVER-60-48</b> 8031414937981 FANEU00027370 Ausgang 48V 1.25A 60W Eingang 100~264VAC 48VD	<b>Konstantspannung / constant voltage</b> Output 48V 1.25A 60W Input 100~264VAC 48VD	170 x 35 x 23 mm
	<b>I-DRIVER-100-48</b> 8031414937998 FANEU00027371 Ausgang 48V 2.08A 100W Eingang 175~264VAC	<b>Konstantspannung / constant voltage</b> Output 48V 2.08A 100W Input 175~264VAC	145 x 48 x 24 mm
	<b>I-DRIVER-150-48</b> 8031414938001 FANEU00027372 Ausgang 48V 3.12A 150W Eingang 175~264VAC	<b>Konstantspannung / constant voltage</b> Output 48V 3.12A 150W Input 175~264VAC	195 x 48 x 24 mm
	<b>I-DRIVER-200-48</b> 8031414938018 FANEU00027373 Ausgang 48V 4.16A 200W Eingang 200~240VAC	<b>Konstantspannung / constant voltage</b> Output 48V 4.16A 200W Input 200~240VAC	215 x 48 x 24 mm
	<b>I-DRIVER-300-48</b> 8031414938025 FANEU00027374 Ausgang 48V 6.25A 300W Eingang 200~240VAC	<b>Konstantspannung / constant voltage</b> Output 48V 6.25A 300W Input 200~240VAC	236 x 49 x 29 mm
	<b>I-DRIVER-SL-100-24</b> 8031414937943 FANEU00027407 Ausgang 24V 4.2A 100W Eingang 175~264VAC	<b>Konstantspannung / constant voltage</b> Output 24V 4.2A 100W Input 175~264VAC	217 x 27 x 23 mm
	<b>I-DRIVER-SL-150-24</b> 8031414937950 FANEU00027369 Ausgang 24V 6.25A 150W Eingang 175~264VAC	<b>Konstantspannung / constant voltage</b> Output 24V 6.25A 150W Input 175~264VAC	217 x 27 x 23 mm
	<b>I-DRIVER-SL-200-24</b> 8031414937967 FANEU00027405 Ausgang 24V 8.33A 200W Eingang 175~264VAC	<b>Konstantspannung / constant voltage</b> Output 24V 8.33A 200W Input 175~264VAC	217 x 27 x 23 mm
	<b>I-DRIVER-SL-250-24</b> 8031414937974 FANEU00027406 Ausgang 24V 10.4A 250W Eingang 200~240VAC	<b>Konstantspannung / constant voltage</b> Output 24V 10.4A 250W Input 200~240VAC	292 x 31,3 x 22,6 mm
	<b>I-DRIVER-SL-36-24</b> 8031414937929 FANEU00027363 Ausgang 24V 1.5A 36W Eingang 100~240VAC	<b>Konstantspannung / constant voltage</b> Output 24V 1.5A 36W Input 100~240VAC	94 x 25 x 20 mm
	<b>I-DRIVER-SL-60-24</b> 8031414937936 FANEU00027364 Ausgang 24V 2.5A 60W Eingang 175~264VAC	<b>Konstantspannung / constant voltage</b> Output 24V 2.5A 60W Input 175~264VAC	222 x 19,5 x 18 mm

# DIMMER

Dimmer-Taste /  
Dimmer button

 	<b>I-DIMMER-D1-10</b>	8031414877959	 1-10V DC
	FANEU00001592		
	D1-10 Dimmer	D1-10 dimmer	22,5 × 22,5 × 48,6 mm
	Dimmbereich	Dimming range	
	1%-100% 1-10V 40mA	1%-100% 1-10V 40mA	
 	<b>I-DIMMER-D1-10S</b>	8031414896257	 1-10V DC
	FANEU00001593		
	D1-10 Dimmer	D1-10 dimmer	83,5 × 83,5 × 44 mm
	Dimmbereich	Dimming range	
	1%-100% 1-10V 40mA	1%-100% 1-10V 40mA	
 	<b>I-DIMMER-D350S</b>	8031414896264	 1-100% TRIAC
	FANEU00001594		
	Dimmer mit Phasenanschnitt	Trailing edge dimmer	83,5 × 83,5 × 44 mm
	220~240VAC	220~240VAC	
	10~350W 1.5A	10~350W 1.5A	

# NOTFAHRER / EMERGENCY DRIVER



## I-DRIVER-EMERGENCY

8031414864751  
FANEU00001648

Not-Driver  
6-60 V 400-40 mA 4W 180 min  
Batterie 3,6 V 3,0 Ah Ni-Cd

Emergency driver  
6-60V 400-40mA 4W 180Min  
Battery 3,6V 3,0Ah Ni-Cd

160 × 38 × 28 mm



## I-DRIVER-HELP

8031414862559  
FANEU00001654

Not-Driver  
Ausgangsspannung 10-120V  
Eingangsspannung 85-265V  
3-40 W, Notfall 120 min  
18650 Li-Ionen-Batterie 3,7 V 2.4Ah

Emergency driver  
Output Voltage 10-120V  
Input Voltage 85-265V  
3-40W. emergency 120 min.  
18650 Li-Ion Battery. 3,7V 2.4Ah

131 × 55 × 21 mm



## I-DRIVER-HELP-HV

8031414882595  
FANEU00001655

Notausgang  
Spannung 230V AC, geeignet für:

2,5W Notversorgung  
3 Stunden Notbetrieb

3,5W Notversorgung  
2 Stunden Notbetrieb

5W Notversorgung  
1,5 Stunden Notbetrieb

Batterie 18650 LiFePO4 6,4 V 1500 mAh

Emergency output  
voltage 230V AC, suitable for:

2,5W emergency power  
3 hours emergency time

3,5W emergency power  
2 hours emergency time

5W emergency power  
1,5 hours emergency time

Battery 18650 LiFePO4 6.4V 1500mAh

160 × 38 × 28 mm

# DIMMER

Dimmer für  
LED-Streifen  
12-24-48V /  
Dimmer for  
12-24-48V  
LED Strip



**DIM-PUSH-CV**  
8031414939183  
FANEU00027728

Der Dimmer PUSH-CV ist ein PWM-Dimmer mit extrem niedriger Spannung von 12, 24 und 48V DC und für die Steuerung von LED-Streifen und dimmbaren PWM-LED-Lasten geeignet. Der Dimmer kann über Drucktaste (N/O, Schließer) gesteuert werden, 0-10 V oder 1-10 V über aktiven Stellantrieb (der daher eine variable Spannung zwischen 0 und 10V erzeugt) und Potentiometer mit 100k. In der Einschaltphase ist der PUSH-CV in der Lage, das Eingangssystem zu erkennen und sich automatisch für den angeschlossenen Steuereingang zu konfigurieren.

The PUSH-CV dimmer is a low voltage 12, 24, and 48V DC PWM dimmer suitable for controlling LED strips and dimmable PWM LED loads. The dimmer can be controlled via a push button (N/O normally open), 0-10V or 1-10V from an active actuator (which generates a variable voltage between 0 and 10V) and a 100k potentiometer. Upon powering on, the PUSH-CV is capable of recognizing the input system and automatically configuring itself for the connected control input.

48 × 48 × 22,5 mm

**DIM-DALI2-CV-M2**  
8031414939190  
FANEU00027729



PWM-Dimmer mit extrem niedriger Spannung von 12, 24 und 48V DC und für die Steuerung von LED-Streifen und dimmbaren PWM-LED-Lasten geeignet. Geeignet für die Steuerung von Led-Streifen mit 12/24/48V über die Haustechniksysteme Bticino/Vimar mit Ausgang mit Phasenanschnitt. Steuerbar mittels:  
- BUS DALI oder DALI2  
- Taste (N/O, Schließer) mit Netzspannung oder 12-24-48V  
- Analoges Signal 0-10V oder 1-10V über aktiven (der daher eine variable Spannung zwischen 0 und 10V erzeugt) oder passiven Stellantrieb  
- Potentiometer mit 47 KOhm  
- Anwesenheitssensor

PWM dimmer for low voltage 12, 24, and 48V DC suitable for controlling LED strips and dimmable PWM LED loads. Suitable for controlling 12/24/48V LED strips from Bticino/Vimar home automation systems with phase-cut output. Controllable via:  
- DALI or DALI2 bus  
- Button (N/O normally open) at mains voltage or 12-24-48V  
- Analog signal 0-10V or 1-10V from an active actuator (which generates a variable voltage between 0 and 10V) or passive  
- 47KOhm potentiometer  
- Presence sensor

48 × 48 × 22,5 mm

**DIM-PUSH-4CV**  
8031414939206  
FANEU00027730



PUSH-Eingang Konstantspannungsausgang  
- Dimmer mit vier getrennten monochromen Ausgängen mit vier Eingängen  
- Push und Bluetooth-Steuerung  
- Anzeige-LED der korrekten Versorgung

PWMPUSH input Constant voltage PWM output  
- Dimmer with four separate monochromatic outputs, four  
- Push inputs, and Bluetooth control  
- LED indicator for correct power supply

90 × 71 × 32,2 mm

**DIM-DALI-4CV**  
8031414939213  
FANEU00027731



DALI-Eingang Konstantspannungsausgang  
- Dimmer mit vier getrennten monochromen Ausgängen mit Eingang DALI DT6

PWMDALI Input Constant Voltage PWM Output  
- Dimmer with four separate monochromatic outputs with DALI DT6 input

71 × 90 × 32,2 mm

Dimmer für  
LED-Streifen 230V  
oder dimmbare  
LED-Glühbirnen /  
Dimmer for 230V  
LED Strips or  
dimmable LED bulbs



**DIM-PUSH-230-AI**  
8031414939220  
FANEU00027732

PUSH-Eingang Phasenanschnittausgang ohne  
Notwendigkeit der Änderung der Hausanlage.

Push entry, phase-cut output without  
the need to modify the home system.

22 × 45 × 40 mm



**DIM-PUSH230-500-AI**  
8031414939237  
FANEU00027733

PUSH-Eingang Phasenanschnittausgang  
- Kompakte Abmessungen  
- Optimierter Phasenanschnitt für LED-Streifen mit Netzspannung  
- Versorgungsbereich: 80÷230V AC 50/60Hz  
- Ausgangsleistung 220W A 110V, 440W A 220V, 500W A 230V  
- Max. ohmsche Last 1A

Input PUSH Phase-cut Output  
- Compact dimensions  
- Phase-cut optimized for mains voltage LED STRIP  
- Power range: 80÷230V AC 50/60Hz  
- Output power: 220W at 110V, 440W at 220V, 500W at 230V  
- Maximum resistive load 1A

48 × 48 × 22,8 mm



**DIM-PUSH230-350-AI**  
8031414939244  
FANEU00027734

PUSH-Eingang Phasenanschnittausgang  
- Kompakte Abmessungen  
- Optimierter Phasenanschnitt für LED-Streifen mit Netzspannung  
- Versorgungsbereich: 80 ÷ 230V AC 50/60Hz  
- Ausgangsleistung 110W bei 110V, 220W bei 220V, 230W bei 230V  
- Max. ohmsche Last 1A

Input PUSH Phase-cut Output  
- Compact dimensions  
- Phase-cut optimized for mains voltage LED STRIP  
- Power range:  
80÷230V AC 50/60Hz  
- Output power: 220W at 110V, 440W at 220V, 500W at 230V  
- Maximum resistive load 1A

48 × 48 × 22,8 mm

## UMRICHTER / CONVERTERS

	<b>DIM-DALI230-AI</b> 8031414939251 FANEU00027735		
	DALI2-Eingang Phasenanschnittausgang - Dimmer Phasenanschnittausgang mit DALI2-Eingang - AI Edge-Ausgang mit MOSFET - Ausgangsleistung 110W bei 110V, 220W bei 220V, 230W bei 230V - Max. ohmsche Last 1A	DALI2 Input Phase Cut Output - Phase cut dimmer with DALI2 input - AI Edge output with MOSFET - Power delivered: 110W at 110V, 220W at 220V, 230W at 230V - Maximum resistive load: 1A	48 × 48 × 22,8 mm
	<b>DIM-DALI230-500-AI</b> 8031414939268 FANEU00027736		
	DALI2-Eingang Phasenanschnittausgang Dimmer DIN-SCHIENE, Phasenanschnittausgang mit Push-Eingang, DALI2 - Trailing Edge-Ausgang mit MOSFET - Versorgungsbereich: 80 ÷ 230V AC 50/60Hz - Max. Ausgangsleistung Version DALI2-230V-500W-AI: 500W	DALI2 Input Phase Cut Output - DIN Rail Dimmer, phase cut output with Push input, DALI2 - Trailing Edge output with MOSFET - Power supply range: 80÷230V AC 50/60Hz - Maximum power delivered for version DALI2-230V-500W-AI: 500W	105 × 90 × 58 mm
	<b>DIM-DALI230-1KW-AI</b> 8031414939275 FANEU00027737		
	DALI2-Eingang Phasenanschnittausgang - Dimmer DIN-SCHIENE, Phasenanschnittausgang mit Push-Eingang, DALI2 - Trailing Edge-Ausgang mit MOSFET - Versorgungsbereich: 80 ÷ 230V AC 50/60Hz - Max. Ausgangsleistung Version DALI2-230V-1KWW-AI: 1000W	DALI2 Input Phase Cut Output - DIN Rail Dimmer, phase cut output with Push input, DALI2 - Trailing Edge output with MOSFET - Power supply range: 80÷230V AC 50/60Hz - Maximum power delivered for version DALI2-230V-1KWW-AI: 1000W	105 × 90 × 58 mm
	<b>DIM-PHASECUT-DALI</b> 8031414939282 FANEU00027738		
	Phasenanschnitteingang Ausgang DALI BROADCAST - Schnittstelle mit Phasenanschnitteingängen für Netzteile und dimmbare Lampen mit DALI-Eingang Netzteil des DALI-Busses, bis zu 16 Geräte eingebaut - Konvertierungsfunktion von Phasenanschnitt (z. B. Haustechnik Bticino/Vimar) auf DALI	Phase-cut input DALI BROADCAST output - Interface with phase-cut inputs for power supplies and dimmable lamps with DALI input - Integrated DALI bus power supply for up to 16 devices - Operation of conversion from phase-cut (e.g., Bticino/Vimar home automation) to DALI	40 × 80 × 24,5 mm
	<b>DIM-O10-230-1KW</b> 8031414939299 FANEU00027739		
	Dimmer 230V 1CH PUSH 010V 1000W		105 × 90 × 58 mm
	<b>DIM-DALI2-1RELE</b> 8031414939305 FANEU00027740		
	DALI-Eingang Relaisausgang - Stellantrieb DALI2 Relaisausgang bistabil - Versorgung über DALI-Bus	DALI Input Relay Output - DALI2 Actuator Relay Output Bistable - Power Supply from DALI Bus	48 × 48 × 22,8 mm
	<b>DIM-WIFI-16DALI</b> 8031414939312 FANEU00027741		
	Dimmer für Netzteile DALI Eingang PUSH / Wi-Fi oder Bluetooth OIKOS - DALI-Ausgang an bis zu 16 Geräte adressierbar - Kompatibel mit Sprachassistenten Amazon Alexa und Google Nest im WI-FI-Modus	Dimmer for DALI power supplies with PUSH / Wifi or Bluetooth input OIKOS - DALI output addressable up to 16 devices - Compatible with Amazon Alexa and Google Nest voice assistants in WIFI mode	40 × 80 × 24,5 mm
	<b>DIM-WIFI-DALI</b> 8031414939329 FANEU00027742		
	Dimmer für Netzteile DALI Eingang PUSH / Wi-Fi oder Bluetooth OIKOS - DALI-Broadcast-Ausgang für bis zu 16 Geräte - Kompatibel mit Sprachassistenten Amazon Alexa und Google Nest im WI-FI-Modus	DALI dimmer for PUSH / Wifi or Bluetooth OIKOS power supplies - DALI Broadcast output for up to 16 devices - Compatible with Amazon Alexa and Google Nest voice assistants in WIFI mode	40 × 80 × 24,5 mm

# REMOTE CONTROLS

## ÜBERSICHT DER STEUERKOMPONENTEN / CONTROLS COMPONENTS SCHEME

Dieser Abschnitt unseres Katalogs ist den Empfängern und Controllern für Streifen und Beleuchtungsprodukte mit Niederspannung gewidmet und soll Ihre Wohnung in eine intelligente und interaktive Umgebung verwandeln.

Unsere Produktpaletten an Zubehörteilen ist dazu konzipiert, allen Beleuchtungsanforderungen gerecht zu werden, gleich ob es sich um monochrome Beleuchtung, CCT, RGB oder RGB+CCT handelt. Jedes Produkt ist darauf ausgelegt, Vielseitigkeit und Benutzerfreundlichkeit zu garantieren und gestattet es Ihnen so, dank der mit IP-Isolierung ausgestatteten Modelle einzigartige und individuell gestaltete Atmosphären in jeder Umgebung zu schaffen, gleich ob im Innen- oder Außenbereich.

Für diejenigen, die nach einer hochentwickelten Steuerung Ausschau halten, bieten wir auch Artikel an, die die Steuerung der Beleuchtung mittels Wi-Fi ermöglichen. Mit einer dedizierten App und der Möglichkeit der Verwendung von Sprachbefehlen können Sie die Lichtstärke Ihrer Streifen und anderer Beleuchtungsprodukte direkt über Ihr Smartphone oder Sprachassistenten einschalten, ausschalten und regulieren.

Erkunden Sie unseren Katalog und erfahren Sie, wie unsere Empfänger und Controller Ihr Beleuchtungserlebnis verbessern können und so Ihr Zuhause smarter, funktioneller und einladender machen.

This section of our catalog is dedicated to receivers and controllers for strips and low-voltage lighting products, designed to make your home an intelligent and interactive environment.

Our range of accessories is crafted to meet every lighting need, whether it's monochromatic lighting, CCT, RGB, or RGB+CCT. Each product is designed to ensure versatility and ease of use, allowing you to create unique and personalized atmospheres in any space, both indoors and outdoors, thanks to models equipped with IP isolation.





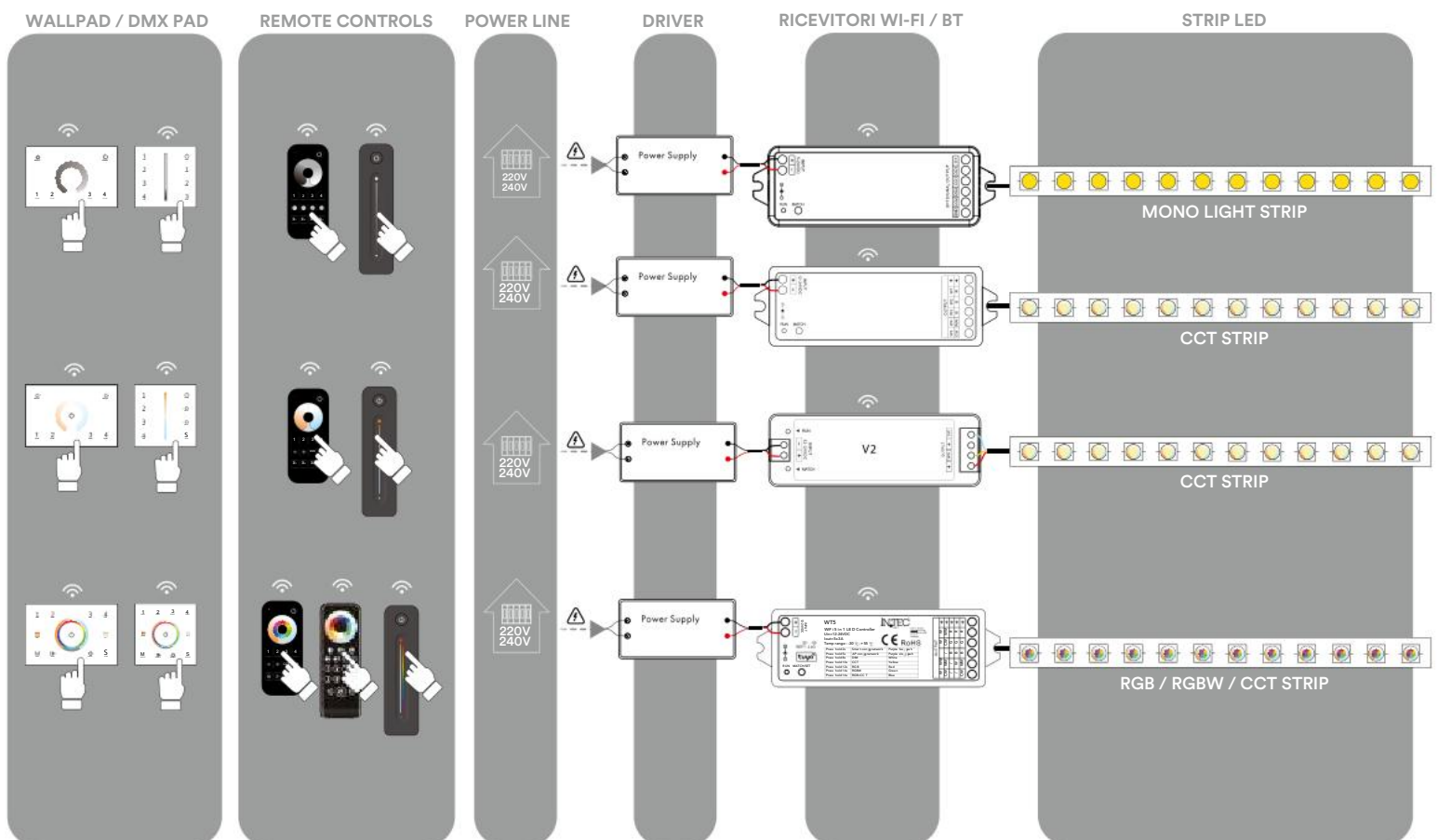







For those seeking advanced control, we also offer items that allow for managing lights via Wi-Fi. With a dedicated app and the ability to use voice commands, you can turn on, turn off, and adjust the brightness of your strips and other lighting products directly from your smartphone or through voice assistants.

Explore our catalog and discover how our receivers and controllers can enhance your lighting experience, making your home smarter, more functional, and welcoming.







# REMOTE CONTROL

	<p><b>RF-WALLPAD-1CH</b> 8031414876426 FANEU00008460</p> <p>Wallpad RF 2.4G 4-Zonen-Dimmersteuerung 1 Kanal 2xAAA nicht enthalten</p>	<p>RF 2.4G wallpad dimming light 4 zone 1 channel 2xAAA not included</p>	 86 × 86 × 36,5 mm
	<p><b>RF-WALLPAD-2CH</b> 8031414876433 FANEU00008461</p> <p>Wallpad RF 2.4G CCT weiß, dynamisch 4 Zonen 2 Kanäle 2xAAA nicht enthalten</p>	<p>RF 2.4G wallpad CCT adjustable white 4 zone 2 channels 2xAAA not included</p>	 86 × 86 × 36,5 mm
	<p><b>RF-WALLPAD-5CH</b> 8031414876440 FANEU00008462</p> <p>Wallpad RF 2.4G RGB/RGBW/RGB+CCT 4 Zonen 5 Kanäle 2xAAA nicht enthalten</p>	<p>RF 2.4G wallpad RGB/RGBW/RGB+CCT 4 zone 5 channels 2xAAA not included</p>	 86 × 86 × 36,5 mm
	<p><b>RF-DMXPAD-1CH</b> 8031414876457 FANEU00008450</p> <p>Wallpad RF 2.4G 4-Zonen-Dimmersteuerung 1 Kanal 230V mit Protokoll DMX 512 anschießbar</p>	<p>RF 2.4G wallpad dimming light 4 zone 1 channel 230V linkable with DMX512 protocol</p>	 120 × 80 × 37 mm universelle Größe für Anschlussdose 503 / universal size for 503 box
	<p><b>RF-DMXPAD-2CH</b> 8031414876464 FANEU00008451</p> <p>Wallpad RF 2.4G CCT, weiß, dynamisch 4 Zonen 2 Kanäle 230V mit Protokoll DMX 512 anschießbar</p>	<p>RF 2.4G wallpad CCT adjustable white 4 zone 2 channels 230V collegabile con protocollo DMX 512</p>	 120 × 80 × 37 mm universelle Größe für Anschlussdose 503 / universal size for 503 box
	<p><b>RF-DMXPAD-5CH</b> 8031414876471 FANEU00008452</p> <p>Wallpad RF 2.4G RGB/RGBW/RGB+CCT 4 Zonen 5 Kanäle 230V mit Protokoll DMX 512 anschießbar</p>	<p>RF 2.4G wallpad RGB/RGBW/RGB+CCT 4 zone 5 channels 230V collegabile con protocollo DMX 512</p>	 120 × 80 × 37 mm universelle Größe für Anschlussdose 503 / universal size for 503 box

# REMOTE CONTROL

	<p><b>RF-COM-1CH</b> 8031414876402 FANEU00008439</p> <p>Fernbedienung RF 2.4G 4-Zonen-Dimmersteuerung 1 Kanal 2xAAA nicht enthalten</p> <p>RF 2.4G remote control dimming light 4 zone 1 channel 2xAAA not included</p> 
	<p><b>RF-COM-2CH</b> 8031414876396 FANEU00008441</p> <p>Fernbedienung RF 2.4G CCT weiß, dynamisch 4 Zonen 2 Kanäle 2xAAA nicht enthalten</p> <p>RF 2.4G remote control CCT adjustable white 4 zone 2 channels 2xAAA not included</p> 
	<p><b>RF-COM-5CH</b> 8031414876419 FANEU00008443</p> <p>Fernbedienung RF 2.4G RGB/RGBW/RGB+CCT 4 Zonen 2 Kanäle 2xAAA nicht enthalten</p> <p>RF 2.4G remote control CCT adjustable white 4 zone 2 channels 2xAAA not included</p> 
	<p><b>RF-COM-5CH-1ZN</b> 8031414897919 FANEU00008444</p> <p>Steuerung RGB+CCT 1 Zone Batterie CR2032</p> <p>RGB+CCT Remote Control 1 zone Battery CR2032</p>
	<p><b>RF-COM-1CH-1ZN</b> 8031414897896 FANEU00008440</p> <p>Helligkeitssteuerung 1 Zone Batterie CR2032</p> <p>Brightness Remote Control 1 zone Battery CR2032</p>
	<p><b>RF-COM-2CH-1ZN</b> 8031414897902 FANEU00008442</p> <p>Steuerung CCT 1 Zone Batterie CR2032</p> <p>CCT Remote Control 1 zone Battery CR2032</p>
	<p><b>RF-COM-5CH-8ZN</b> 8031414897926 FANEU00008445</p> <p>Fernbedienung RF 2.4G RGB/RGBW/RGB+CCT 8 Zonen Batterien nicht enthalten: 2xAAA nicht enthalten</p> <p>8 scene 2xAAA non include RF Remote Controller 8 zones 8 scenes Battery: 2xAAA not included</p>

# REMOTE CONTROL

	<p><b>RF-RICEVITORE-1CH</b> 8031414897933 FANEU00008454</p> <p>Empfänger RF 2.4G 1 Kanal (K) für WALLPAD FERNBEDIENUNG WALLPAD DMX für EINE FARBE verwendbar Eingang 8,5 A 12-24V Ausgang 1K 8 A - 40W/96W/192W/288W</p>	<p>RF 2.4G receiver box 2 channels for WALLPAD RADIOCOMANDO WALLPAD DMX usable for SINGLE COLOR Input 8.5A 12-24V Output 1CH 8A - 40W/96W/192W/288W</p>	<p>97 × 33 × 18 mm</p>
	<p><b>RF-RICEVITORE-2CH</b> 8031414876488 FANEU00008455</p> <p>Empfänger RF 2.4G 2 K für WALLPAD FERNBEDIENUNG WALLPAD DMX für EINE FARBE/CCT verwendbar Eingang 10,5 A 12-24V Ausgang 2K; 5 A/K - 2x(60-120)W</p>	<p>RF 2.4G receiver box 2 channels for WALLPAD RADIOCOMANDO WALLPAD DMX usable for SINGLE COLOR/CCT Input 10.5A 12-24V Output 2CH;5A/CH - 2x(60-120)W</p>	<p>97 × 33 × 18 mm</p>
	<p><b>RF-RICEVITORE-5CH</b> 8031414876495 FANEU00008457</p> <p>Empfänger RF 2.4G 5 Kanäle für WALLPAD FERNBEDIENUNG WALLPAD DMX für EINE FARBE/RGB/RGBW/RGB+CCT verwendbar Eingang 15,5 A 12-24V Ausgang 5K; 3 A/K - 5x(36-72)W</p>	<p>F 2.4G receiver box 5 channels for WALLPAD RADIOCOMANDO WALLPAD DMX usable for SINGLE COLOR/RGB/RGBW/RGB+CCT Input 15.5A 12-24V Output 5CH;3A/CH - 5x(36-72)W</p>	<p>114 × 38 × 20 mm</p>
	<p><b>RF-RICEVITORE-5CH-PRO</b> 8031414882724 FANEU00008458</p> <p>Empfänger RF 2.4G 5 Kanäle für WALLPAD FERNBEDIENUNG WALLPAD DMX für EINE FARBE/CCT/RGB/RGBW/RGB+CCT verwendbar Eingang 30,5 A 12-48V Ausgang 5K;6A/K 12/24V 5 x (72-144)W 5K;4A/K 36/48V - 5x(144-192)W</p>	<p>RF 2.4G receiver box 5 channels for WALLPAD RADIOCOMANDO WALLPAD DMX usable for SINGLE COLOR/CCT/RGB/RGBW/RGB+CCT Input 30.5A 12-48V Output 5CH;6A/CH 12/24V 5x(72-144)W 5CH;4A/CH 36/48V - 5x(144-192)W</p>	<p>179 × 56 × 30 mm</p>
	<p><b>RF-RICEVITORE-4CH-IP67</b> 8031414882717 FANEU00008456</p> <p>Empfänger RF 2.4G 4 Kanäle für WALLPAD FERNBEDIENUNG WALLPAD DMX für EINE FARBE/RGB/RGBW verwendbar Eingang 20,5 A 12-36V Ausgang 4K; 5 A/K - 4x(60-180)W</p>	<p>RF 2.4G receiver box 4 channels for WALLPAD RADIOCOMANDO WALLPAD DMX usable for SINGLE COLOR/RGB/RGBW Input 20.5A 12-36V Output 4CH;5A/CH - 4x(60-180)W</p>	<p>176 × 78 × 38 mm</p>



# REMOTE CONTROL

 <p><b>WI-FI</b> SMART INTEC</p>	<p><b>RF-WIFI-CONTROL-5CH</b> 8031414878710 FANEU00008463</p> <p>Empfänger Wi-Fi + RF 2.4G 5 Kanäle für WALLPAD FERNBEDIENUNG WALLPAD DMX für EINE FARBE/CCT/ RGB/RGBW/RGB+CCT verwendbar Eingang 15,5 A 12-24V Ausgang 5K; 3 A/K - 5x(36-72)W</p> <p>Wi-Fi + RF 2.4G receiver box 5 channels for WALLPAD RADIOCOMANDO WALLPAD DMX usable for SINGLE COLOR /CCT/RGB/RGBW/RGB+CCT Input 15.5A 12-24V Output 5CH;3A/CH - 5x(36-72)W</p> <p>114 × 38 × 20 mm</p> <p>Powered by <b>tuya</b> Intelligence Inside</p>
 <p><b>SMART INTEC</b> <b>BLUETOOTH</b> SIG MESH</p>	<p><b>RF-BT-CONTROL-5CH</b> 8031414878826 FANEU00008438</p> <p>Empfänger Bluetooth + RF 2.4G 5 Kanäle für WALLPAD FERNBEDIENUNG WALLPAD DMX für EINE FARBE/CCT/ RGB/RGBW/RGB+CCT verwendbar Eingang 15,5 A 12-24V Ausgang 5K; 3 A/K - 5x(36-72)W</p> <p>Bluetooth + RF 2.4G receiver box 5 channels for WALLPAD RADIOCOMANDO WALLPAD DMX usable for SINGLE COLOR /CCT/RGB/RGBW/RGB+CCT Input 15.5A 12-24V Output 5CH;3A/CH - 5x(36-72)W</p> <p>114 × 38 × 20 mm</p> <p>Powered by <b>tuya</b> Intelligence Inside</p>
	<p><b>RF-AMPLIFICATORE-5CH</b> 8031414882700 FANEU00008437</p> <p>5-Kanal-Verstärker Eingang 25,5 A 12-24VDC Ausgang 5K; 5 A/ K 12/24V - 5x(60-120)W</p> <p>5 Channel amplifier Input 25.5A 12-24VDC Output 5CH;5A/ CH 12/24V - 5x(60-120)W</p> <p>107 × 75 × 24,5 mm</p>
	<p><b>RF-AMPLIFICATORE-2CH</b> 8031414882694 FANEU00008436</p> <p>2-Kanal-Verstärker Eingang 16,5 A 12-36 VDC Ausgang 2K; 8 A/ K 12/36V - 2x(96-288)W</p> <p>2 Channel amplifier Input 16.5A 12-36VDC Output 2CH;8A/ CH 12/36V - 2x(96-288)W</p> <p>175 × 45 × 27 mm</p>
	<p><b>RF-RIPETITORE</b> 8031414882731 FANEU00008459</p> <p>Signalverstärker RF 2.4G AC100-240V DC 12-24V</p> <p>RF 2.4G signal Repeater AC100-240V DC12-24V</p> <p>52 × 52 × 26 mm</p>

# SPI CONTROLLER

Controller and Empfänger für digitale LED-Streifen: dazu konzipiert, eine genaue und dynamische Steuerung jedes einzelnen Pixels zu garantieren. In diesem Abschnitt finden Sie eine große Auswahl an innovativen Lösungen, die es ermöglichen, außerordentliche und individuell abgestimmte Beleuchtungseffekte zu erzielen.

Unsere spezifischen Controller für Lauflichteffekte sind ideal, um fließende und dynamische Lichtabfolgen zu erzeugen. Diese Geräte sind **perfekt für Anwendungen, die kontinuierliche und ansprechende Lichtbewegungen erfordern wie architektonische Dekorationen und künstlerische Installationen.**

**Für diejenigen, die Treppen auf funktionelle und dekorative Weise beleuchten möchten, bieten wir eigens für diesen Verwendungsbereich ausgelegte Controller an.** Diese Geräte garantieren eine sichere und eindrucksvolle Beleuchtung, indem sie die Lichtspiele mit dem Schritt des Benutzers synchronisieren und so eine einladende und sichere Atmosphäre schaffen.

Tauchen Sie mit unseren hochmodernen Controllern in die Welt der RGB-Lichtspiele ein, die es gestatten, Farben und Beleuchtungseffekte mittels App, Fernbedienung oder DMX einzustellen und zu steuern. Gleich, ob es darum geht, mitreißende Atmosphären für Events zu erzeugen oder einen Hauch von Magie für Innenbereiche hinzuzufügen, bieten diese Controller eine unvergleichliche Flexibilität und gestatten es Ihnen, jede kreative Idee zum Leben zu erwecken.

Controllers and receivers for digital LED strips: designed to ensure precise and dynamic control of each individual pixel. In this section, you will find a wide range of innovative solutions that enable the creation of extraordinary and customized lighting effects.

Our controllers specifically designed for run effects are ideal for creating smooth and dynamic light sequences. These devices are **perfect for applications that require continuous and captivating light movements, such as architectural decorations and artistic installations.**

**For those looking to illuminate staircases in a functional and decorative way, we offer controllers specifically designed for this application.** These devices ensure safe and evocative lighting, synchronizing light effects with the user's steps, creating a welcoming and secure atmosphere.

Dive into the world of RGB light shows with our advanced controllers, which allow you to set and manage colors and lighting effects via app, remote control, or DMX. Whether it's creating engaging atmospheres for events or adding a touch of magic to indoor spaces, these controllers offer unparalleled flexibility, enabling you to bring any creative idea to life.



# SPI CONTROLLER



## RF-PIR-CONTROL-SPI

8031414927326

FANEU00008453

Der SPI-Controller für RGB- oder Weißlicht steuert LED-Lichter über Bewegungssensoren und Tasten. Er kann zwei digitale LED-Lichtgruppen steuern und unterstützt dabei verschiedene integrierte Schaltkreise (IC) und gestattet es, den Typ des Schaltkreises und die Farbreihenfolge zu wählen. Dies ist für die Treppenbeleuchtung nützlich, da so verschiedene Situationen wie durchgehende Beleuchtung oder Farbwechsel geboten werden. Es können mehrere Controller für eine zentralisierte Steuerung angeschlossen und so Farben, Geschwindigkeit und Helligkeit der Lichter reguliert werden.

Input voltage: 5-24VDC;  
Output type: 2\*SPI(TTL),  
Input type: PIR sensor + Push button  
Pixel number: Max 960  
Comes with 2 PIR Sensors(ER-C),  
1 daylight sensor and 2 PIR sensor extension line(5m)  
Compatible with 28 kinds driving ICs

The SPI controller for RGB or white lights manages LED lights through motion sensors and buttons. It can control two groups of digital LED lights, supporting various types of integrated circuits (IC) and allowing the selection of the IC type and the color order. It is useful for stair lights, offering different modes such as continuous light or color transitions. It can connect multiple controllers for centralized control and allows for the adjustment of colors, speed, and brightness of the lights.

Compatible ICs: TM1804, TM1809, TM1812, UCS1903, UCS1909, UCS1912, UCS2903, UCS2909, UCS2912, WS2811, WS2812, TM1829, TM1914A, GW6205, GS8206, GS8208, LPD6803, LPD1101, D705, UCS6909, UCS6912, LPD8803, LPD8806, WS2801, WS2803, P9813, SK9822, SM16703P.

186 × 86 × 25 mm



## RF-CONTROL-32CH-SPI

8031414927364

FANEU00008447

Der Controller für Treppenbeleuchtung ist ein Gerät, das zum Einschalten des Lichts einen Bewegungssensor (PIR) verwendet. Er kann LED-Streifen mit Niederspannung mit 32 Kanälen steuern, von denen jeder in der Lage ist, bis zu 1A Strom zu verwalten. Er unterstützt verschiedene RGB-LED-Streifen und verfügt für eine mühelose Bedienung über ein OLED-Display mit 3 Tasten. Er bietet vier Beleuchtungsarten mit Einstellung von Farbe, Geschwindigkeit und Helligkeit.

Input voltage: 5-24VDC;  
Output voltage: 32 x (5-24)VDC;  
32CH, 1A/CH; 32 x (5-24)W  
Output type:  
Constant voltage + SPI(TTL)  
Reverse Polarity Protection  
Comes with 2 PIR Sensors(ER-C)  
and 1 daylight sensor,  
2 PIR sensor extension line(5m)

The stair light controller is a device that uses a motion sensor (PIR) to turn on the lights. It can control low-voltage LED strips with 32 channels, each capable of handling up to 1A of current. It supports various types of RGB LED strips and features an OLED display with 3 buttons for easy management. It offers four lighting modes, with adjustments for color, speed, and brightness.

Compatible ICs: TM1804, TM1809, TM1812, UCS1903, UCS1909, UCS1912, UCS2903, UCS2909, UCS2912, WS2811, WS2812, TM1829, TM1914A, GW6205, GS8206, GS8208, LPD6803, LPD1101, D705, UCS6909, UCS6912, LPD8803, LPD8806, WS2801, WS2803, P9813, SK9822, SM16703P.

186 × 86 × 25 mm



## RF-AMPLIFIER-SPI-6CH

8031414941070

FANEU00027787

Für den Empfang von Signalen von einem Controller konzipiertes Gerät, indem die Informationen verstärkt werden, um gleichzeitig mehrere LED-Streifen zu verwalten. Es ist möglich, die Farben und die Beleuchtungsarten zu synchronisieren. Mit RF-CONTROL-SPI kompatibel.

5-24VDC; 30A max.  
Input signal: SPI(TTL) (1 group)  
Output signal: SPI(TTL) (6 groups)  
Reverse polarity protection

Device designed to receive signals from a controller, amplifying the information to simultaneously manage multiple LED strips. It is possible to synchronize colors and lighting modes.  
Compatible with RF-CONTROL-SPI.

145 × 75 × 35 mm

**LED-FORREST-SPI**8031414927319  
FANEU00006234

Controller für Pixel-to-Pixel-LED-Streifen mit "LAUFLICHT"-Effekt.  
Starten der Show und Ausschalten über N/O-Taste.  
Kompatibel mit LED-Streifen Pixel to Pixel, SPI WS2811 oder anderen Protokollen.  
Streifenlänge, Richtung und Geschwindigkeit mittels APP NewlabForrest programmierbar.  
Synchronisationsausgang für multiple Laufflichteffekte.

Pixel to Pixel LED strip controller with "RUN" effect.  
Show start and turn off via N/O button.  
Compatible with Pixel to Pixel SPI WS2811 LED strips or other protocols.  
Strip length, direction and speed programmable via NewlabForrest APP.  
Synchronization output for multiple chasing effects.

**RF-CONTROL-SPI**8031414927340  
FANEU00008448

Kompakter Multi-Pixel-Controller, der die Steuerung von farbigen LED-SPI-Streifen auf einfache und praktische Weise gestattet.  
Kompatibel mit RF-Fernbedienung. Der Controller bietet 40 verschiedene dynamische Beleuchtungsmöglichkeiten. Diese umfassen Effekte wie Laufflicht, Verfolgung, Fluss und fließenden Farbverlauf, was die Beleuchtung angenehmer und abwechslungsreicher macht.

Compact multi-pixel controller that allows for easy and practical control of colored SPI LED strips. Compatible with RF remote control. The controller offers 40 different dynamic lighting modes. These include effects such as running, chasing, flowing, and smooth color transitions, making the lighting much more enjoyable and varied.

97 × 33 × 18 mm

5-24VDC; 8A  
Input signal: RF2.4G;  
work with R9 remote;  
Output signal: SPI (TTL)  
Control dots: 1024  
Dynamic mode:  
32 kinds color light, 8 kinds white light  
Compatible with  
49 kinds of Driving Ics

Compatible ICs: TM1803, TM1804, TM1809, TM1812, UCS1903, UCS1909, UCS1912, SK6813, UCS2903, UCS2909, UCS2912, WS2811, WS2812, WS2813, WS2815, TM1829, TLS3001, TLS3002, GW6205, MBI6120, TM1814B(RGBW), SK6812(RGBW), WS2813(RGBW), WS2814(RGBW), UCS8904B(RGBW), LPD6803, LPD1101, D705, UCS6909, UCS6912, LPD8803, LPD8806, WS2801, WS2803, P9813, SK9822, TM1914A, GS8206, GS8208, UCS2904, SM16804, SM16825, SM16714(RGBW), UCS2603, UCS5603, SM16714D, SM16703P, UCS7604(RGBW), UCS7804(RGBW).

97 × 33 × 18 mm

**RF-WIFI-CONTROL-SPI**8031414927333  
FANEU00008464

5-24VDC; 8A  
Input signal: Tuya APP + RF 2.4GHz;  
Output signal: SPI(TTL) x 2  
Control dots: Max.1000  
Rich dynamic effects,  
Multiple music rhythms,  
Wireless remote control  
Compatible with 49 kinds  
of RGB or RGBW LED strips

114 × 38 × 20 mm

**RF-DMX-DECODER-SPI**8031414927357  
FANEU00008449

Der Decoder DMX512 mit SPI und RF-Controller ist ein Gerät, das die Steuerung verschiedener RGB- oder RGBW-SPI-LED-Streifen ermöglicht. Er gestattet die Einstellung von Chiptyp und Farbreihenfolge (rot, grün, blau). Es sind drei verschiedene Betriebsarten möglich: DMX (zur professionellen Steuerung), Stand-alone (unabhängig) und RF (mit Fernbedienung). Im DMX-Modus können Sie eine Adresse für die Steuerung eingeben, während Sie im Stand-alone-Modus Betriebsart, Geschwindigkeit und Helligkeit über die Tasten einstellen können. Mit der RF-Fernbedienung können Sie die Einstellungen mühelos aus der Ferne ändern. Das Gerät bietet außerdem 32 dynamische Beleuchtungsarten wie z. B. Laufflichteffekte.

The DMX512 decoder with SPI and RF controller is a device that allows you to control various types of RGB or RGBW SPI LED strips. It enables you to set the type of chip and the color order (red, green, blue). It can operate in three different modes: DMX (for professional control), stand-alone (independent), and RF (with remote control). In DMX mode, you can set an address for control, while in stand-alone mode, you can adjust the mode, speed, and brightness using the buttons. With the RF remote control, you can easily change the settings from a distance. The device also offers 32 dynamic lighting modes, such as running effects.

5-24VDC  
Input signal: DMX512/RDM+RF 2.4G;  
Output signal: pixel signal  
Control dots: 170 pixels (RGB 510 CH);  
Max 900pixels  
Compatible with 37 kinds of Driving ICs;  
Numeric display  
Reverse Polarity Protection

Compatible ICs: TM1803, TM1804, TM1809, TM1812, UCS1903, UCS1909, UCS1912, SK6813, UCS2903, UCS2909, UCS2912, WS2811, WS2812, WS2813, WS2815, TM1829, TLS3001, TLS3002, GW6205, MBI6120, TM1814B(RGBW), SK6812(RGBW), SM16714(RGBW), SM16703P, SM16714D, WS2813(RGBW), WS2814(RGBW), UCS8904B(RGBW), LPD6803, LPD1101, D705, UCS6909, UCS6912, LPD8803, LPD8806, WS2801, WS2803, P9813, SK9822, TM1914A, GS8206, GS8208, UCS2904, SM16804, SM16825, UCS5603, UCS2603.

170 × 50 × 23 mm

**RF-COM-SPI**8031414927371  
FANEU00008446

RGB/RGBW RF Remote Controller  
1 zone  
Battery: CR2032

58,5 × 9 × 107 mm

# SENSOREN SENSORS

Industrielle  
Bewegungssensoren /  
Industrial motion  
sensors



**LED-SENSOR-TP**  
8031414879724  
FANEU00007349

Load capacity  
no limitation  
220V - 240V



1 / function



In ausreichend heller Umgebung schaltet sich die Lampe nicht ein, auch wenn Bewegung erfasst wird.

With sufficient ambient light, the light will not be switched on even if with motion signal.



In schlecht beleuchteter Umgebung schaltet der Sensor die Lampe ein, sobald eine Bewegung erfasst wird.

With insufficient ambient light, the sensor switches on the light when motion is detected.

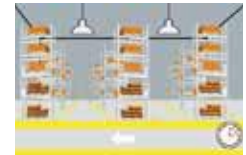

Nach der Wartezeit schaltet der Sensor die Lampe aus, wenn keine Bewegung erfasst wird.

After elapse of hold time, the sensor switches off the light when no motion is detected.



**LED-SENSOR-REMOTE**  
8031414879717  
FANEU00007348

Funkfernsteuerung für Industrielampen-  
sensoren. Industrial sensor remote control.

# SENSOREN SENSORS

An jedes  
Beleuchtungsprodukt  
anpassbare Sensoren /  
Sensors compatible for  
any lighting products



**I-SENSORE-130**  
8031434401219  
FANEU000003599

PIR-Sensor 230V  
max. 1000 W 130°  
Max. Abstand 12 m  
Zeit 10 s - 4 min  
Lux 2 - 2000  
Winklige Zubehörbasis

PIR sensor 230V  
max 1000W 130°  
max 12m.  
time 10 sec. - 4 min.  
lux 2 - 2000  
corner accessory base

  
IP44

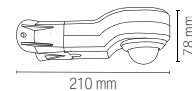















divisione F.A.N. EUROPE LIGHTING s.r.l. a socio unico

Agglomerato A.S.I

**NAPOLI**

Località Bosco Fangone  
80035 Nola (NA)

info@faneurope.it  
+39 081 3151017  
+39 081 8210771

[www.faneurope.it](http://www.faneurope.it)

**MILANO**

Via Monzoro, 46  
20007 Cornaredo (MI)

info@faneurope.it  
+39 02 84345083



**FRANCE**

259 Rue de la Bandido lot 13,  
34160 Castries, France

info@faneurope.it  
+33 7 86659408

**GERMANY**

FAN EUROPE LIGHTING GmbH  
Lichtpromenade 50, 59759 Arnsberg

info@faneurope.it  
+49 2242 9043022



Download Catalogue



SMART INTEC



Download App Smart Intec on:



concept  
**DITRE IDEAS MAKERS**

graphic artwork & photo editing  
**Ditre.com**

photo  
**Quasarfoto.com**

styling  
**Cristina Romanello**  
**Gilda Zoggia**

printed in Italy  
**Graficametelliana.com**  
March 2026

Das Unternehmen behält sich das Recht auf Änderungen der in diesem Katalog enthaltenen Produkte ohne jede Vorankündigung vor.  
/ The company reserves the right to make changes to the products in this catalog without prior notice.



[faneurope.it](http://faneurope.it)